

SERVICE PARTS POLICY

CLAIMS: All claims must be made within 10 days of receipt of shipment. All shipments made F.O.B. Monroe, NC (unless otherwise agreed) and risk of loss shall pass to the Buyer upon shipment.

CORE RETURNS: All rebuilt products are priced with "CORE EXCHANGE DUE". This means a core to be returned shall be the EXACT same product as was purchased with normal wear so that the item can be rebuilt for future sale. The core should be shipped to us as soon as reasonably practical, but no later than 90 days after purchase.

A core charge will be invoiced if the core to be returned is not received by us within 90 days of purchase. If the EXACT same product cannot be returned for some reason, please contact our core department to negotiate a substitution of some other product or products of equivalent value.

RETURNS: A 30% restock charge may be assessed for all unused parts returned to us. Special order items are non-returnable, non-refundable. All returns must be approved prior to shipment and must be shipped prepaid. Credit will be given toward future purchase only and no cash refunds will be given.

REPAIR AND RETURNS: We will replace your unit with the same item from our warehouse to expedite processing while allowing you the advantage of reduced pricing. If the same **exact** item is required back, please submit special instructions. An additional lead time is required for this type of request.

WARRANTY: The warranty for new and rebuilt parts will be **one year** from date of purchase. Wear items are excluded from this warranty. The warranty provides for the replacement or refund only and does not cover any incidental costs incurred by its failure. Warranty is made to the original customer only, and is not transferrable. All warranty products will be shipped back to the customer via UPS Ground at no charge. Freight for return of parts out of warranty will be at the customer's expense.

TECH SUPPORT: ASSA ABLOY Entrance Systems Service Parts is pleased to provide technical support for your staff through our toll-free parts line at 1-888-732-3726 or email address parts.na.besam@assaabloy.com.

Our team of parts experts is on hand to assist you with determining what specific parts of ours, or competitive parts you need for your sliding, swing and revolver door customers.

TABLE OF CONTENTS

The global leader in
door opening solutions

Automatic Sliding Doors

- Handing Guide/UniSlide
- UniSlide Section
- Besam SL500
- Besam SL500 Telescopic
- Besam SL500 CGL
- Besam SL500 Modernization Kits
- Besam SL500 T67
- UniSlide Telescopic
- UniSlide CGL
- UniSlide Cart
- UniSlide Resilience
- UniSlide Jamb Mount Switch
- Power - Glide I and II
- Power - Glide 4000
- Power - Glide 3000 A and B

FSL SINGLE SLIDE

LEFT HAND

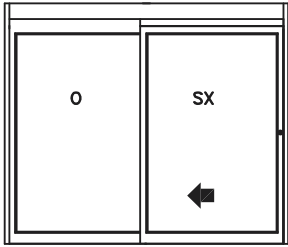

RIGHT HAND

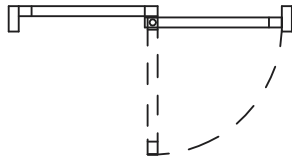
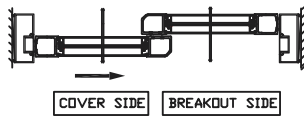
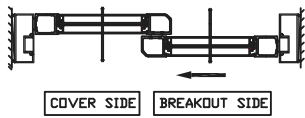
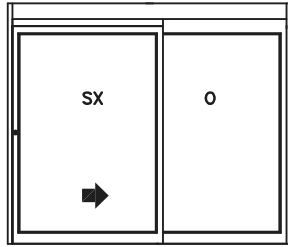

LEFT HAND

VIEW FROM BREAKOUT SIDE

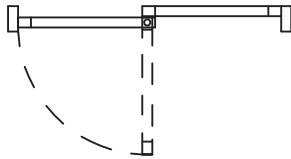

RIGHT HAND

VIEW FROM BREAKOUT SIDE

FBO SINGLE SLIDE

LEFT HAND

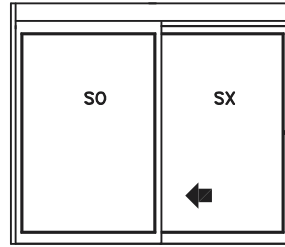

RIGHT HAND

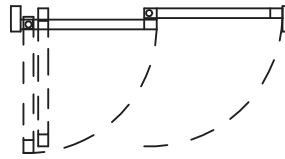
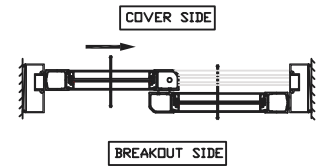
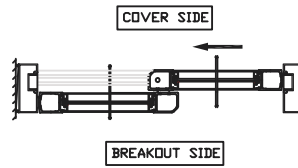
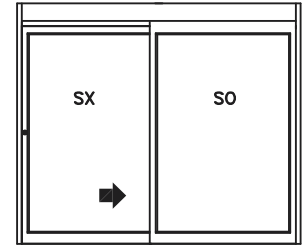

LEFT HAND

VIEW FROM BREAKOUT SIDE

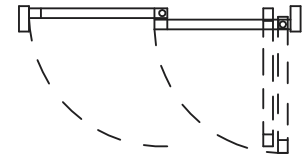

RIGHT HAND

VIEW FROM BREAKOUT SIDE

*NOTE: NON PANIC APPLICATIONS ARE HANDED LIKE A FSL.

SURFACE APPLIED SINGLE SLIDE

LEFT HAND

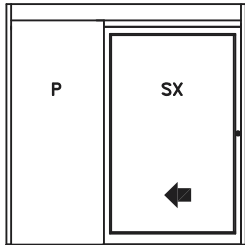

RIGHT HAND

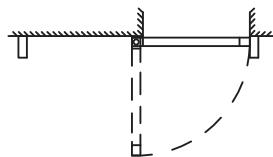
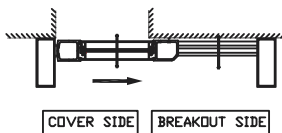
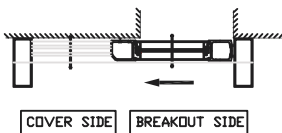
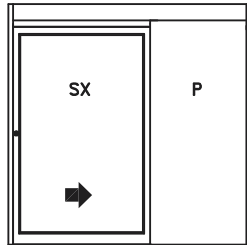

LEFT HAND

VIEW FROM BREAKOUT SIDE

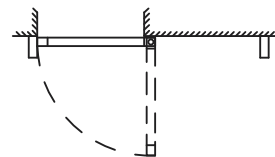

RIGHT HAND

VIEW FROM BREAKOUT SIDE

SURFACE APPLIED REVERSE BREAKOUT SINGLE SLIDE

LEFT HAND

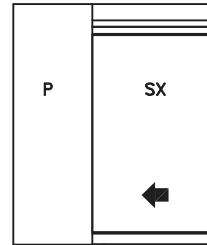

RIGHT HAND

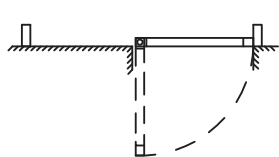
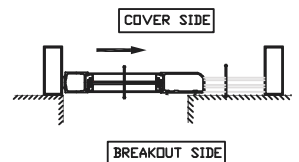
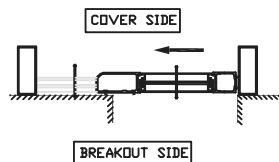
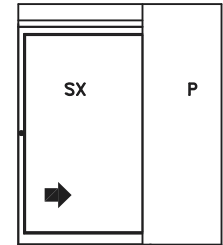

LEFT HAND

VIEW FROM BREAKOUT SIDE

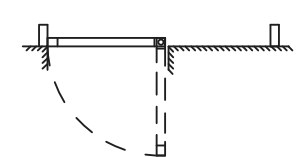

RIGHT HAND

VIEW FROM BREAKOUT SIDE

UNISLIDE TELESCOPIC HANDING GUIDE

TELESCOPIC FSL SINGLE SLIDE

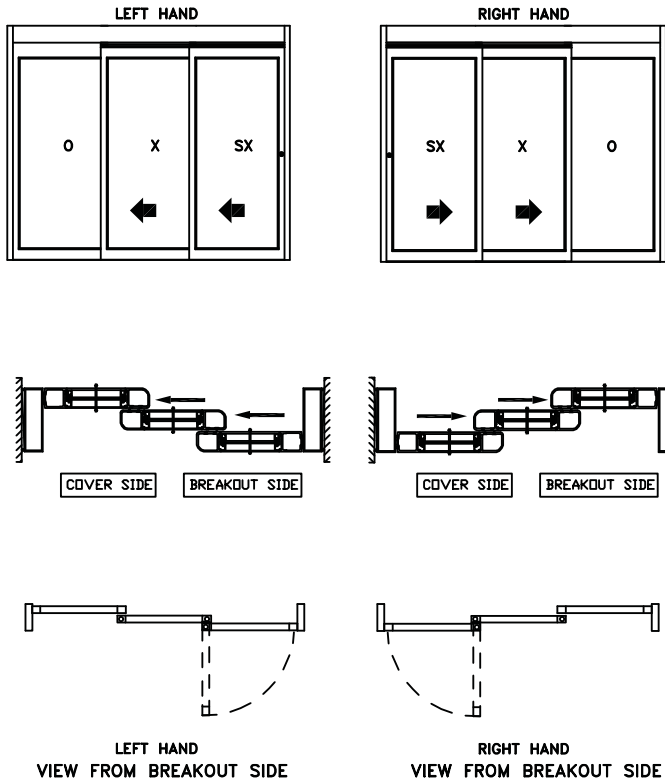

FBO TELESCOPIC SINGLE SLIDE

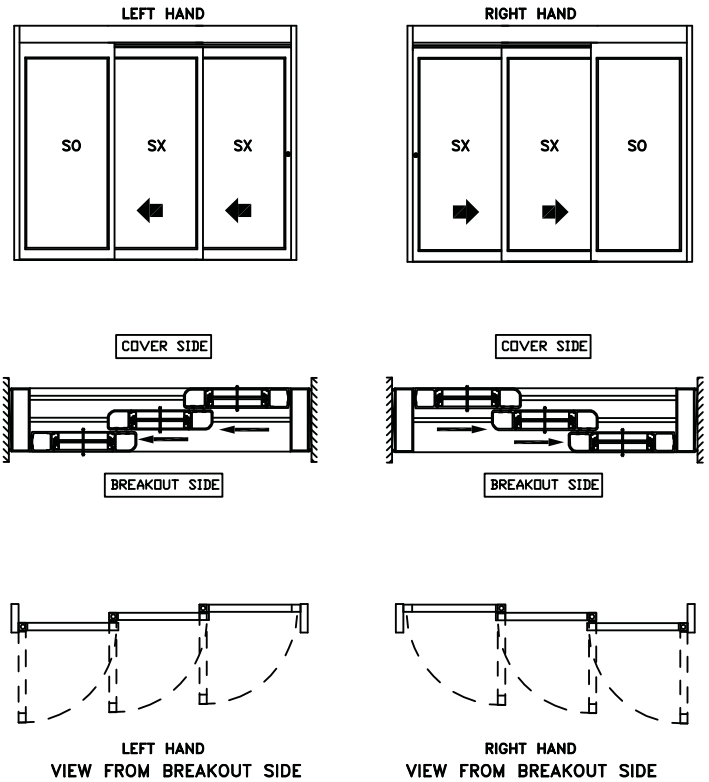

*NOTE: NON PANIC APPLICATIONS ARE HANDED LIKE A FSL.

SURFACE APPLIED SINGLE SLIDE

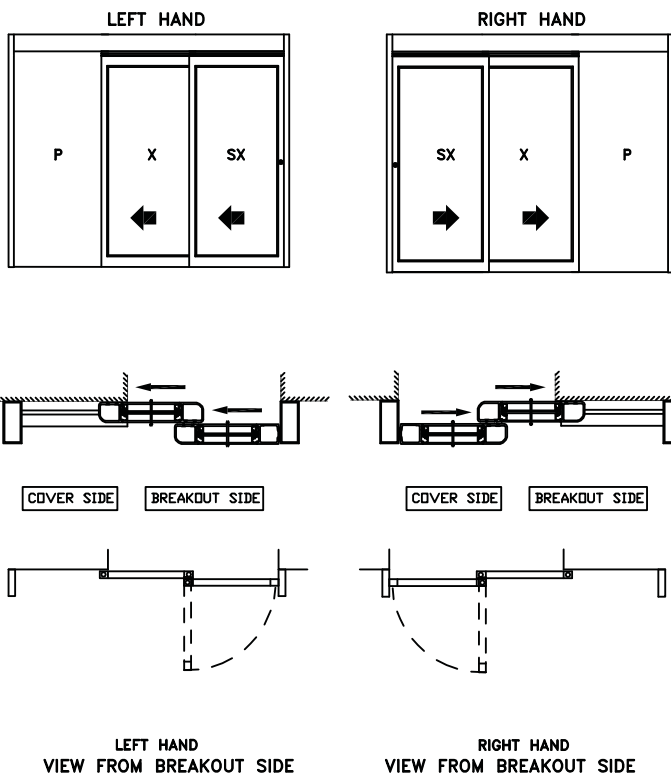

POCKET PACKAGE SINGLE SLIDE

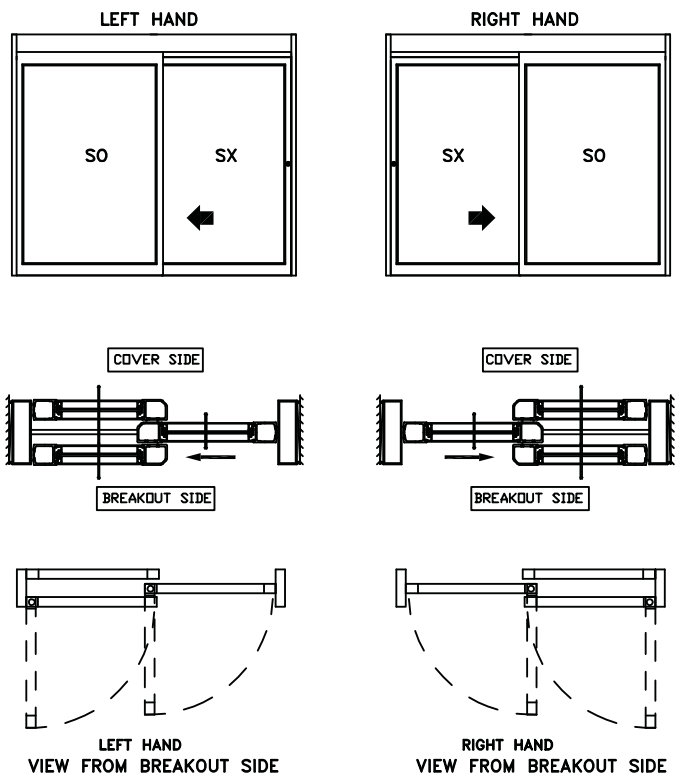

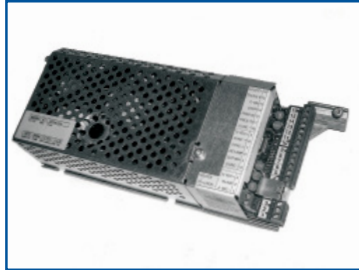

600091 Control, Standard



600091R Control, Rebuilt



331004262H Hermetic Heavy Duty



US02-0640-07 Infrared Lens,
Wide Pattern



US02-0640-08 Infrared Lens,
Narrow Pattern



655952 EXU-1, Extension Unit

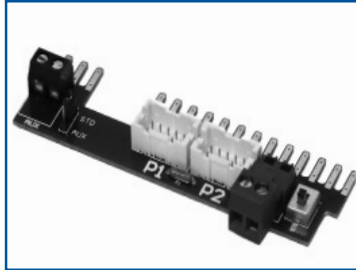

US02-0640-02 Adapter Board



US15-0640-14 Replacement
Sensor Kit, Single, UltraView



US21-0640-06 Cover, UltraView

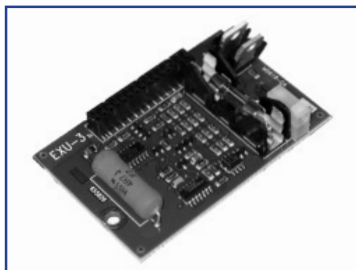

655953 EXU-3, Extension Unit



US02-0640-04 Harness,
UltraView Short, Black 6'



US02-0640-03 Harness,
UltraView Long, Grey 16'



US02-0640-05 Quick Disconnect
Harness, UltraView



550494 Fail/Secure Lock



550516 Fail/Safe Lock





550476 Drive Unit



550476R Drive Unit, Rebuilt



550475 12V Battery Pack

*Order Two 12V, Battery Packs
with Harness for 24V Applications

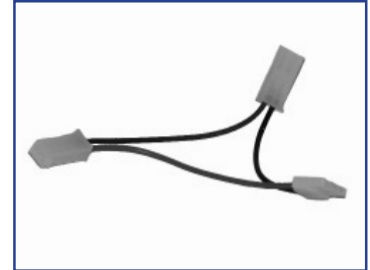

550495 Battery Harness, 24V



600135 PS-5R Switch



1000478 PS-5R Blank Plate



600139 PS-5M Switch



600093 Box Kit



550654 PS-Key



1000595 PS-Knob



US02-0314-04 Cable, 24"



US02-0314-05 Cable, 96"



Remember - search for all parts online at www.besam-usa.com

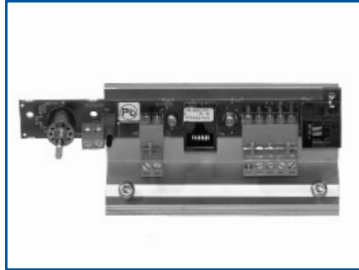

550496 PS5R w/ Bracket



US05-0519-01 Carrier Assembly



724476 Mounting Screw



US09-0519-01 Adjusting Screw
(Included w/**US05-0519-01**)



US05-0519-02 Tandem Wheel



550716 Anti-Riser Wheel

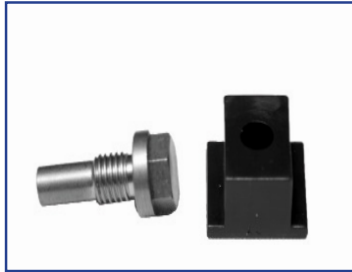

US15-0604-01 Anti-Riser
T-Block and Screw



550569 Belt Fitting Kit



548786-1 Belt Clamp Kit



550474 Tension Wheel
w/Mounting Bracket



735351 Tooth Belt, 9/16" x 6"



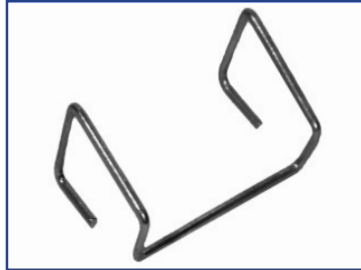

US03-1272-01 Spring,
Retaining, PL Track



US21-0620-02 Roller Track



US05-1287-01 Door Stop PL Kit



US20-0600-01 Door Stop Rubber
Bumper



US05-0277-01 Top Pivot, RH



US15-0277-01 Top & Bottom
Pivot Kit, RH (lower view)



US05-0277-02 Top Pivot, LH



US15-0277-02 Top & Bottom-
Pivot Kit, LH (lower view)



US05-0277-03 Bottom Pivot, RH



US05-0277-04 Bottom Pivot, LH



US15-0285-01 Top & Bottom-
Pivot, Medium Stile, RH



US15-0285-02 Top & Bottom
Pivot, Medium Stile, LH



50-04-235 Mounting Clip, Slick
Tube



Remember - search for all parts online at www.besam-usa.com



US15-0277-03 Bottom Pivot Base Kit



US05-0396-02 Jamless Bottom Pivot Plate, S/L



US15-0396-02 Kit includes washers, screws, and anchors



50-15-137 Active Door Leaf Bottom Roller Kit



50-05-006 Ballcatch, EZ-Fit Bottom



To be superseded by 1010051
(not backwards compatible)



US15-0601-01 Cover Latch Kit

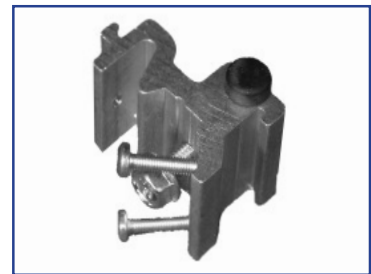

US05-0600-02 Door Stop Kit, RH



US05-0600-01 Door Stop Kit, LH



US20-0600-01 Door Stop Bumper

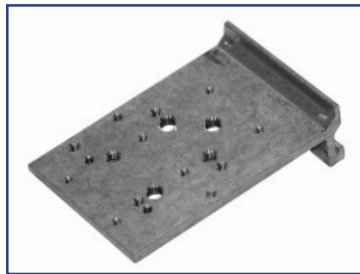

US04-0341-02 Mounting Bracket



724477 Mounting Screws

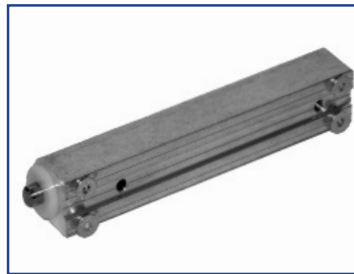

US15-0435-01 Pin Guide Assembly (replaces 50-15-390)

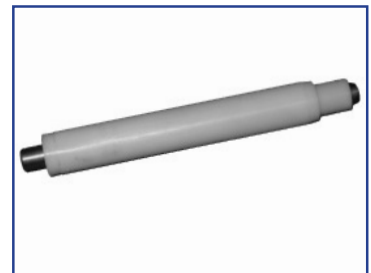

50-04-410 Bottom Pin Guide Stem



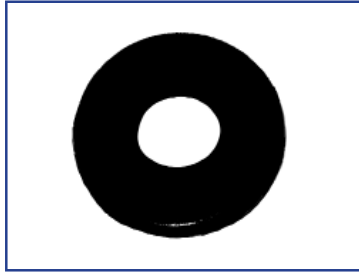

50-21-002 Guide, Washer Spacer

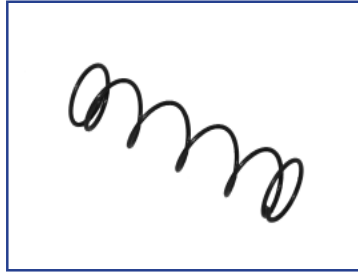

50-04-411 Lower Spring Guide



50-15-396 Track Guide Assembly, Lower, 48"



50-15-396L Track Guide Assembly, Lower, 60"



50-15-475 Pin Guide Track, 48"



50-15-475L Pin Guide Track, 96"



50-20-135 Track Cap, 12'



50-15-167 Non-Panic Bottom Guide Kit



US15-0644-02 Roller Guide Assembly



50-09-152 Mounting Screw



50-15-148 Guide, Roller Shaft and Wheels Only
USE US15-0644-02



50-15-146 Roller Guide Kit (2 ea)



50-08-8805 Roller Guide (1 ea)



50-09-146 Split Washer (1 ea)



Remember - search for all parts online at www.besam-usa.com

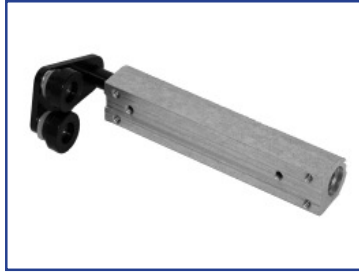

US15-0644-03 Roller Guide Assembly, FSL, Long Axle



50-09-152 Mounting Screw



US15-0513-01 Wheel Kit, DHD Roller

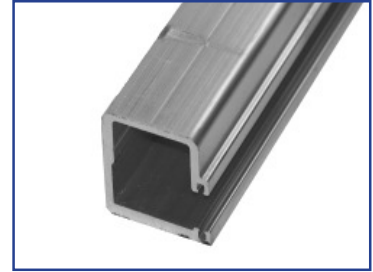

50-04-146 Bottom Guide Channel, FSL, 42"



50-04-147 Bottom Guide Channel, FSL, 48"



US20-0731-01 Interlock Cover



US15-0434-01CL Interlock Set, CL



US15-0434-01BK Interlock Set, BK

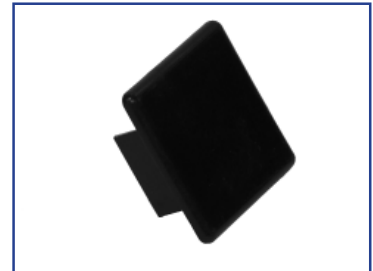

US21-0327-03 Endcap, Door Carrier

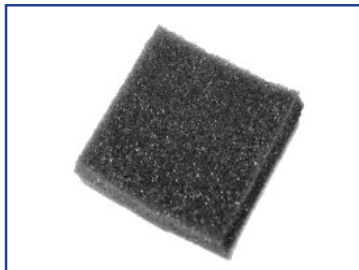

US20-0327-01 Cushion, End Cap



US05-0545-01 PSA Arm



US03-0545-01HK PSA Arm Hardware Kit





US15-0322-01 Damper
w/Mounting Hardware

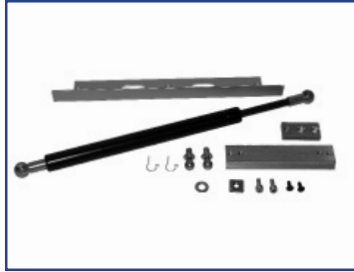

US15-0391-01 Active Leaf
Damper, CL



US15-0322-02 Sidelite
Damper Kit, CL



US15-0322-03 Sidelite
Damper Kit, DB



US21-1295-01 Bushing, 1", Heyco



US21-1276-01 Sensor Grommet
(Pictured Above)



US15-0391-02 Active Leaf
Damper, DB



11-02-175 Switch, w/12' Lead
N/C Magnetic, CL

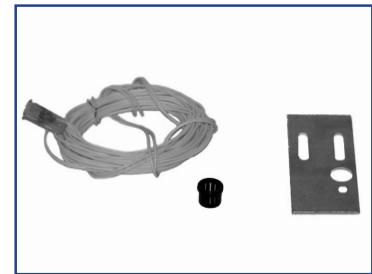

US15-0306-01 Switch, Magnetic
Breakout, FSL, less below items



70-02-203 Bar Magnet A for above



US04-0324-01 Nut plate for above



US09-0306-01 Screws (2) for above



11-02-176 Magnetic Strip, 3/4",
FSL, By the Foot



50-15-410 Panic, FS, Switch
incl 11-02-176 & US15-0306-01



US05-0305-01 Assembly Ring
Magnet, FBO



550492 Microswitch, LSK



Remember - search for all parts online at www.besam-usa.com

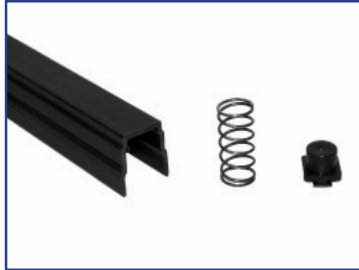

US09-0350-01 Fast Lock Spring



US21-0350-01 Fast Lock Post



US21-0350-LL Fast Lock Extrusion



US21-0311-01 Endcap Plankcap, Right



US21-0311-02 Endcap Plankcap, Left

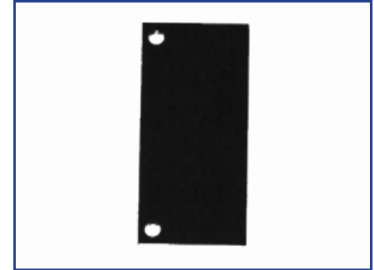

US04-0760-01 Coverplate Pocket Panel



US04-0346-02 Endplate, SA, w/6" Jamb

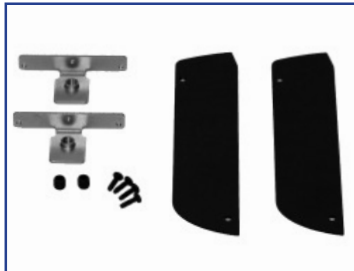

US15-0346-01 Endplate w/Jamb



US04-1270-01 Endplate, PL Cover, BK



US04-0302-01 Endplate, Header, BK



US04-0303-01 Telescopic Endplate, BK



US04-1271-01 Endplate, Clad, PL, BK



US04-0592-01 Telescopic Endplate, Clad, BK



US04-0591-01 Endplate, Clad, BK





US04-1278-01 Endplate, 6",
PL Clad
OBSOLETE



US04-1277-01 Endplate,
6" Jamb, PL Cover, LH



US04-1277-02 Endplate,
6" Jamb, PL Cover, RH

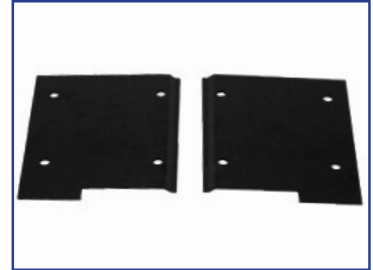

US04-1274-01 Endplate, PL,
SA, LH



US04-1274-02 Endplate, PL,
SA, RH



US04-0345-01 Endplate, SA,
w/o Jambs, LH



US04-0345-02 Endplate, SA,
w/o Jambs, RH

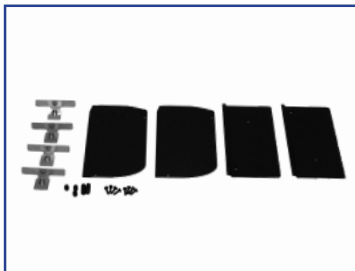

US15-0345-01 Endplate Kit
Complete, Less Jambs



US03-0347-01 Mounting Angle
Endplate



04-09-723447 Screw for
Endplates



US03-1265-01 Jamb Bracket,
PL, LH



US03-1265-02 Jamb Bracket,
PL, RH



US03-0740-01 Jambless
Mounting Bracket



Remember - search for all parts online at www.besam-usa.com

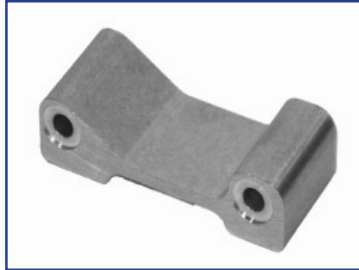

US04-0282-01 Mounting Block
Dog Bone, Plank to Jamb Tube

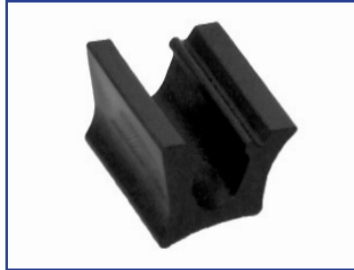

US21-0954-01 Cover Stay,
Delrin



US15-0342-01 Connection Unit
Assembly



713405 Fuse 6.3 AT Slow



713983 Fuse 10 AT Slow



US02-0583-16 Fuse, 2A, 250V



65-21-021 Bushing, Snap,
1" Hole



US21-0531-01 Plug, 1/2", Heyco



US05-0751-01 Door Closer,
Concealed

Replaced by US05-0751-02



US09-0600-01 Cover Lock
Screw

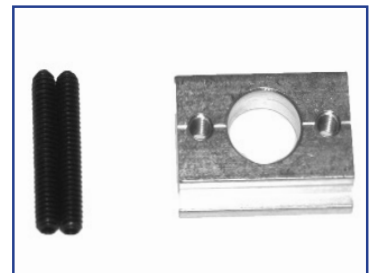

19-15-007 Lock Block Kit, 2-pt,
Bi-Part





550467 Cable Clip



US03-0277-05 Plate, Top Pivot
Damper, 4-Hole



US03-1266-01 Plate, Top Pivot
Damper, 4-Hole



US04-0948-01 Lock Strike,
Clear (Above - Left)



US04-0948-02 Lock Strike,
Black (Above - Right)



US21-1730-01 T-Block



US08-1653-01 Glass Block,
Neoprene, Duro 85



1010051 Ball Catch, Bottom
Rail



US05-0685-05 Sweep Assembly
(Incl. extr., brush, clips)



US04-0684-02 Clip (1 only)



US08-1746-01 Heyco Plug,
Black (Left pic shown)



US08-1746-02 Heyco Plug,
Grey (Right pic shown)



Remember - search for all parts online at www.besam-usa.com

BESAM SL500

ASSA ABLOY

The global leader in
door opening solutions

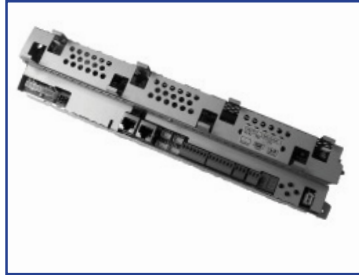

1007773 Control Unit - Core Required - NEW



1007093 Nut M6 (2)



1007726 Screw Dri-Loc (2)

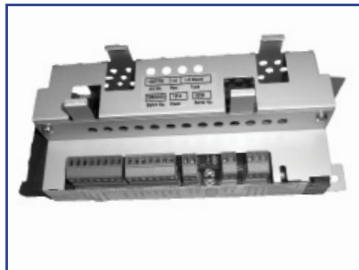

1007779 I/O Board Assembly- Core Required- NEW



Same Mtg hardware as 1007773



1009493 Sequencing Relay Assembly (Target only)



1007035 Drive Unit, Heavy Duty- Core Required - NEW



1008184 Connection Unit Assembly



656078 Wiring Harness



1008147 Power Supply Assembly- Core Required- NEW



Same Mtg hardware as 1007773



1008523 Power Supply Cable - Replaced by 1010475

1010475 Power Supply Cable



1008425 Battery Backup, 12V, Fail open function only.



24V Battery Backup, Fail open, Fail close or convenience mode functions requires (2) of the above plus (1) **550495** Y-Wire harness.

phone: 888-732-3726

parts.na.besam@assaabloy.com

fax: 800-304-9459

© ASSA ABLOY Entrance Systems US Inc.

1 Rev D

BESAM SL500

ASSA ABLOY

The global leader in
door opening solutions



1008354 Lock, Electric, Fail Safe



1008167 Lock, Electric, Fail Secure



1007118 Tension Wheel Assembly Complete



330000341 Wheel only



1009163 Tandem Wheel Holder w/ Wheels & Anti-riser- Quiet Ride



1006223 Tandem Wheel Assembly, Plastic - Quiet Ride



1010786 Carriage Wheel Assy, HD



1007033 2 Wheel Holder



1010370 HD Wheel



1008492 Clip - Tandem Wheel



1009164 Quad Wheel Holder w/ Wheels and Anti-riser

Obsolete -use 1010786 above



1008493 Clip - Quad Wheel Assembly



Remember - search for all parts online at www.besam-usa.com

© ASSA ABLOY Entrance Systems US Inc.

BESAM SL500

ASSA ABLOY

The global leader in door opening solutions



1006804 Wheel Holder only

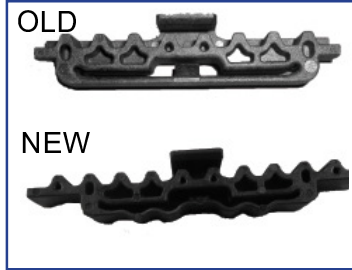

1006906 Belt Clamp -
Replaced by **1012924**

1012924 Belt Clamp

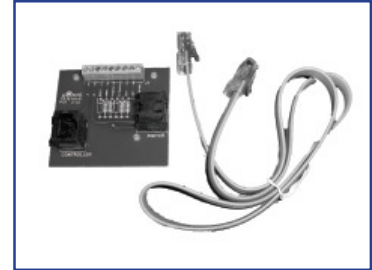

1009426 Accessory Board Kit
Replaced by 1011621 below



1007364 Belt Bracket- Low



1007365 Belt Bracket- High

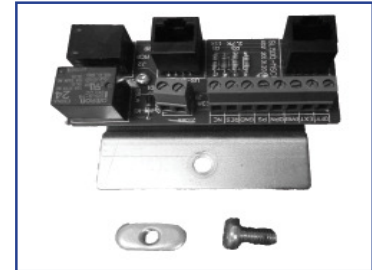

1011621 Mode Selector Conn
Board w/ cable (Metal Bracket)



1009340 5-Pos Mode
Selector Kit



US15-1500-02 Cable Kit



1009341 3-Pos Mode
Selector Kit



US15-1500-02 Cable Kit



1013971 SL500 Mode Selector Conn
Board w/ cable (Plastic Bracket)



1009342 Remote Mode Selector Kit



phone: 888-732-3726

parts.na.besam@assaabloy.com

fax: 800-304-9459

© ASSA ABLOY Entrance Systems US Inc.

3 Rev E

BESAM SL500

ASSA ABLOY

The global leader in
door opening solutions

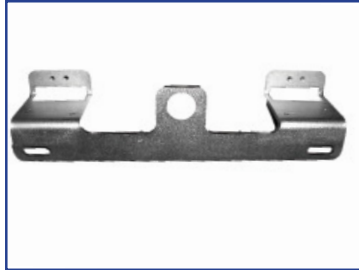

1008742 Accessory Mounting Bracket

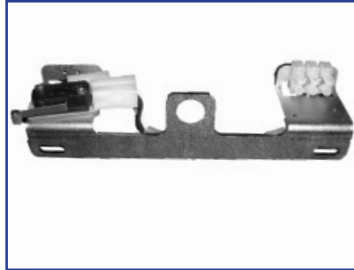

1009457 DP Switch Kit, RH FSL/
LH FBO - Shown above



1009458 DP Switch Kit, LH FSL/
RH FBO



1009488 Cam & Shaft Repair Kit



1008208 End Plate, Plank Cap



1008221 Bracket, Hydraulic
Closer



1008126 Windload Strike Plate

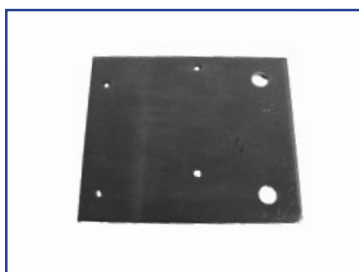

1009276 Key Switch Mtg Plate



1007343 Beam Mtg Plate 'A' -
Power Supply Side



1007344 Beam Mtg Plate 'B' -
Tension Wheel Side



Remember - search for all parts online at www.besam-usa.com

© ASSA ABLOY Entrance Systems US Inc.

BESAM SL500

ASSA ABLOY

The global leader in
door opening solutions

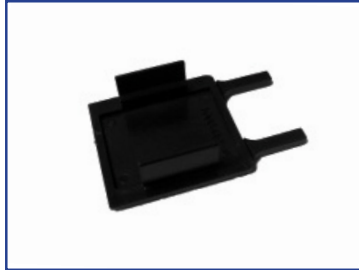

1008415 End Cap, Carrier,
Leading Edge

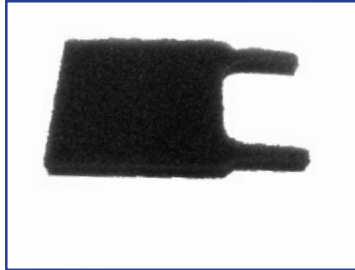

1008416 End Cap Cushion



1008287 Spring Clip Assembly,
Sidelite



1007413 Transom Mullion Cap



1007412 Transom Sag Rod Nut

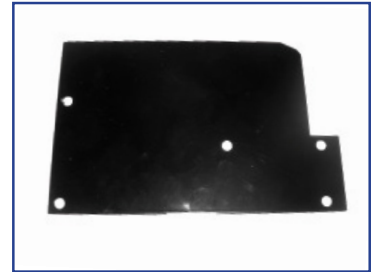

1008737 SA Jambless Mounting
Plate



1008112 Door Stop Assembly



1007353 Door Stop Rubber



1007475 Plate Filler, 6"

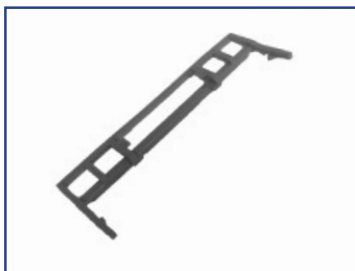

1007049 Anti-riser only



1008769 Jambless Mtg Plate
Plug, 1/2"



phone: 888-732-3726

parts.na.besam@assaabloy.com

fax: 800-304-9459

© ASSA ABLOY Entrance Systems US Inc.

BESAM SL500

ASSA ABLOY

The global leader in
door opening solutions



1008094 Cover Latch Assembly



1007531 Detachment Guard

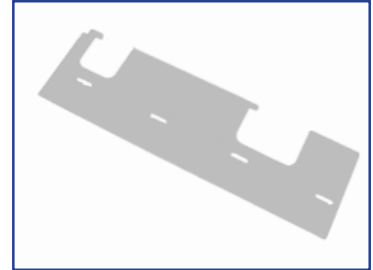

1008278 Cable Cover,
Control Unit

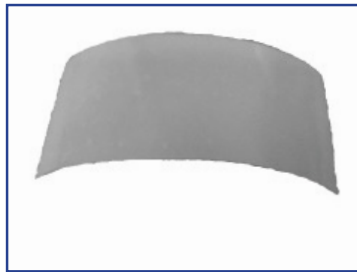

1008364 Cable Cover/Guide

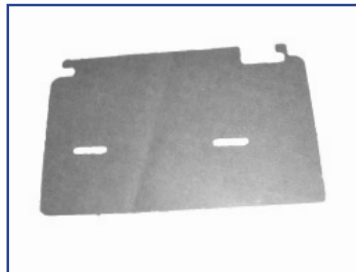

1008280 Cable Cover, I/O Bd.



1009129 Cover Cable Holder



1007093 Nut, Hardware &
Electronic Control



1009605 Position Switch Trigger

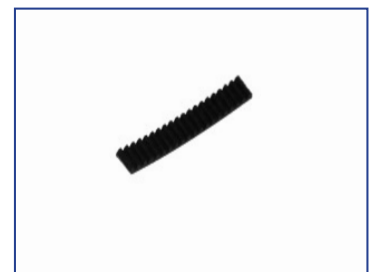

1701406 Belt, MLN 10 GW8M



Remember - search for all parts online at www.besam-usa.com

© ASSA ABLOY Entrance Systems US Inc.

BESAM SL500

ASSA ABLOY

The global leader in
door opening solutions



1009709 Narrow Stile Single Eco Door Package Kit



1009710 Medium/Wide Stile Single Eco Door Package Kit



1009711 Narrow Stile Bi-Part Eco Door Package Kit



*** All Eco Door Kits can also be referred to as U-Factor Kits ***



1009712 Medium/Wide Stile Bi-Part Eco Door Package Kit



1009321 Narrow Stile Bi-Part Eco Door Package Kit, UniSlide



1009322 Medium/Wide Stile Bi-Part Eco Door Package Kit, UniSlide



1009227 Narrow Stile Single Eco Door Package Kit, UniSlide



1009228 Medium/Wide Stile Single Eco Door Package Kit, UniSlide



1010762 Door Position Switch Kit A (Shown)



1010763 Door Position Switch Kit B



phone: 888-732-3726

parts.na.besam@assaabloy.com

fax: 800-304-9459

© ASSA ABLOY Entrance Systems US Inc.

TELESCOPIC

The global leader in
door opening solutions



1702006 Rect. Hole Plug, Telescopic



1009619 Cover Latch
Assembly, Telescopic

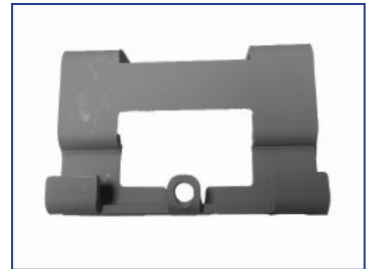

1008450 Lower Transmission
Bracket, Telescopic



1008451 Upper Transmission
Bracket, Telescopic



1010111 Cable Tensioner Assembly,
Telescopic



1010115 Pulley Bracket A,
Telescopic



1010116 Pulley Bracket B,
Telescopic

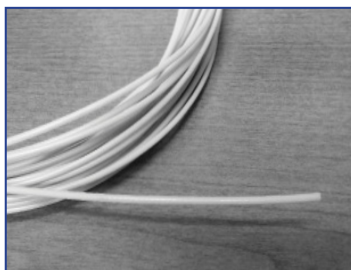

1012969 Pulley Cable 2.28MM,
Telescopic (replaces 1008453)



1012970 Pulley, Metal, Telescopic
(replaces 1008454)



Remember - search for all parts online at www.besam-usa.com

© ASSA ABLOY Entrance Systems US Inc.

TELESCOPIC

The global leader in door opening solutions



1010094 Magnetic Catch A/L#2- Door Portion, Telescopic

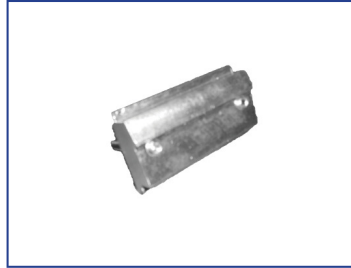

1010092 Magnetic Catch A/L#2 - Carrier Portion, Telescopic

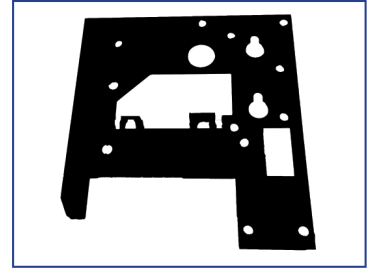

1007345 Jamb Mounting Plate A, Telescopic (Shown)



1007346 Jamb Mounting Plate B, Telescopic

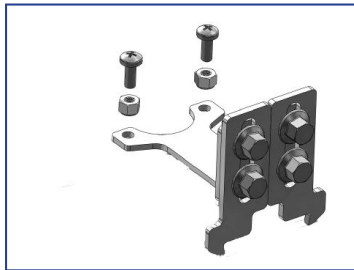

1010748 Electric Lock Bracket Assembly, Telescopic



1010933 SA Jamb Mounting Plate, Telescopic

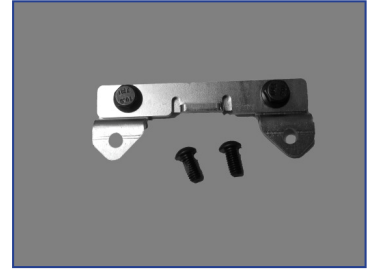

1010117 Transfer Bracket Assembly, Telescopic



US15-0563-01 Roller Wheel Assembly, Telescopic



1010787 Double Sided Removeable Tape, Telescopic (1/2" X 81 Ft RL), Used on 1010590-LLXX replaceable track

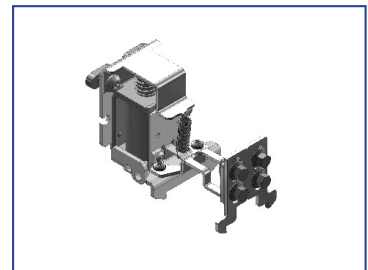

1011004 Lock, Electric, Fail-Safe, Telescopic (Shown)



1011003 Lock, Electric, Fail-Secure, Telescopic



BESAM SL500

ASSA ABLOY

TELESCOPIC

The global leader in
door opening solutions

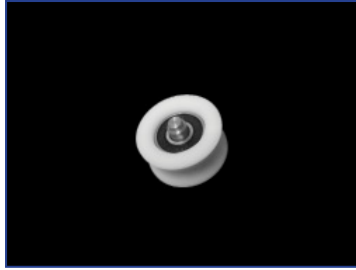

1010370 Solid Carriage Wheel Assembly, CGL, Telescopic, Heavy Package



1011214 Extra Sidelite Cover Latch, Telescopic, Pocket Pkg, SA w/SL



1011208 Cover Lock Bracket, Telescopic, Pocket Pkg, SA w/SL



Remember - search for all parts online at www.besam-usa.com

© ASSA ABLOY Entrance Systems US Inc.

CGL

The global leader in door opening solutions



1010422-05 Shoe Endcap, A/L Top Nose Side, 5-1/2"



1010422-06 Shoe Endcap, A/L Top Nose Side, 5-1/2"



1010422-09 Shoe Endcap, 7" Top/Bottom Nose Side



1010422-10 Shoe Endcap, 7" Top/Bottom Nose Side



1010422-17 Shoe Endcap, 10" Top/Bottom Nose Side



1010422-18 Shoe Endcap, 10" Bottom Nose Side



1010422-21 Shoe Endcap, Lead End A



1010422-22 Shoe Endcap, Lead End B



1010422-07 Shoe Endcap, A/L Top PSA Side



1010422-08 Shoe Endcap, A/L Top PSA Side



1010422-11 Shoe Endcap, 7" Top /Bottom PSA Side



1010422-12 Shoe Endcap, 7" Top /Bottom PSA Side



1010422-19 Shoe Endcap, 10" Bottom PSA Side



1010422-20 Shoe Endcap, 10" Bottom PSA Side



1010422-23 Shoe Endcap, Trail End A



1010422-24 Shoe Endcap, Trail End B

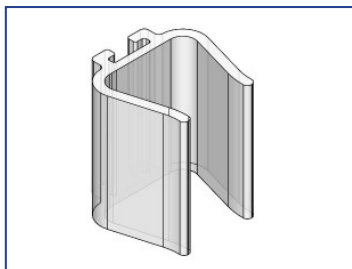

1009664 Seal, 1/2"-3/8" 10 Ft, CGL, Weatherstrip ~ 50-20-6402 (not included)

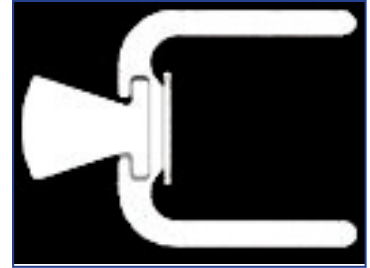

1009890 1/2" Glass Seal End Clip
1009891 3/8" Glass Seal End Cap
Both replaced by 1009664

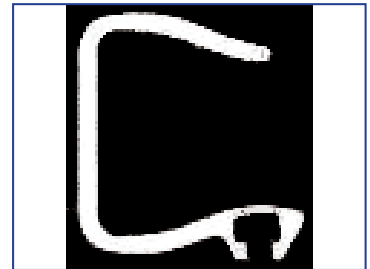

1009663 Glass Seal Clip (1/2" & 3/8") - 10 ft lengths

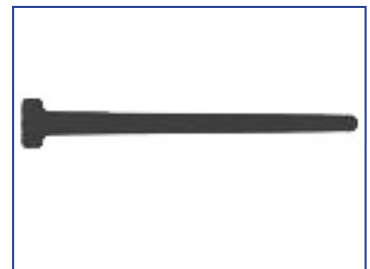

1009665 Weather Seal, CGL



MODERNIZATION KITS

The global leader in
door opening solutions



1011581* Upgrade Kit, Basic, Compact for Basic Doors



1012357* Stanley Duraglide Hardware Kit

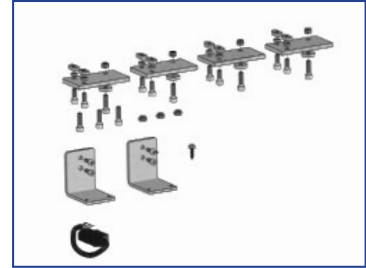

1012471* AMD I & II Kit



*(*ONLY AVAILABLE FOR DISTRICT OR KEY ACCOUNT SALES)*

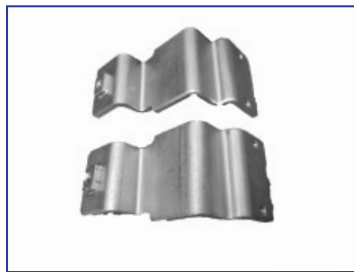

1011747 Transmission Bracket Kit, Compact



1011820 Kit, Battery 12V



1011821 Kit, Battery 24V



331011584 Tension Wheel Assembly Kit



1011742 I/O Board Kit, Compact



1013193 Accessory Board Mtg Kit



Remember - search for all parts online at www.besam-usa.com

© ASSA ABLOY Entrance Systems US Inc.

MODERNIZATION KITS

The global leader in door opening solutions

(*ONLY AVAILABLE FOR DISTRICT OR KEY ACCOUNT SALES)

Besam M SL500 Modernization Bill of Materials		
Baan Part Number	Part Description	SL500 Premium Modernization
1011581	SL500 Modernization kit for slider (includes Power supply, motor/Gearbox on backplate, 30ft of drive belt, Belt clamp, Tension wheel with backplate and belt holder bracket	1
1011747	Belt Bracket kit Besam Unislide	Choose 1
1012357	Belt Bracket kit Stanley Duraglide	
1012471	Belt bracket Kit Besam Powerglide AMD	
Coming soon	Belt bracket kit Stanley Linear Drive	
Coming soon	Belt Bracket Kit Horton Belt Drive	
Coming soon	Belt Bracket Kit Horton Linear Drive	
US15-1500-04	5 position knob switch	1
1011621	Accessory board with bracket	1
1013193	Accessory board mounting kit	1
1008184	Connection Unit Assembly	1
US02-0312-16	Power Cable 16 ft	Optional 1
US02-0300-02	Sensor, BEA Wizard	2 Required (Choose Brand) with Stanguard
US02-1675-01	Sensor, Optex SC32-M (SR221) w/logo	
USB150114	Sensor, cables Wizard	
Optional Accessories		
US15-1500-05	3 position Knob Switch	Optional 1
US15-1500-06	5 Position Key Switch	Optional 1
656078	Wire Harness	Required with Battery Backup (12v & 24V)
1011820	Battery backup 12V (open on power fail)	Optional 1
1011821	Battery backup 24V (operate on power fail)	Optional 1
550495	Y harness required for 24 volt battery backup	1 Required for 24V Battery Backup

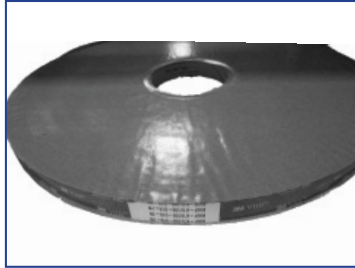

1702779 Glazing Tape

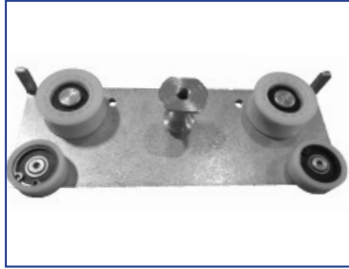

1012546 Wheel Bracket, High Performance



1013804 Dual Cam Wheel Bracket Assembly



1012549 Top Pivot Assembly



1012548 Bottom Pivot Assembly



1013893 Magnetic Catch Ass'y- SL Door Portion

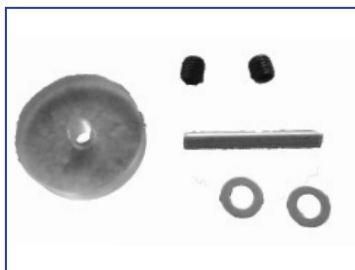

1013787 Spacer Wheel Assembly



1013780-1 Sweep Retention Spring Clip

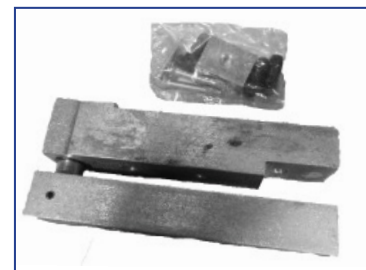

1013527 PSA Arm Assembly



Remember - search for all parts online at www.besam-usa.com

© ASSA ABLOY Entrance Systems US Inc.



1013597 Pin Guide Assembly CVS



1013894 Magnetic Catch Assembly-
AL2 Door Portion

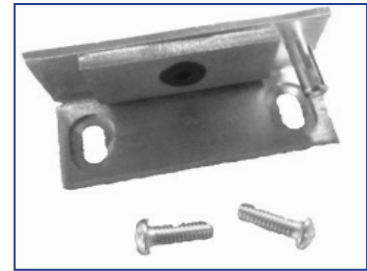

1013812 Magnetic Catch Assembly-
Door Portion



1013913 Pivot Assembly



1013825 Power Supply Cable

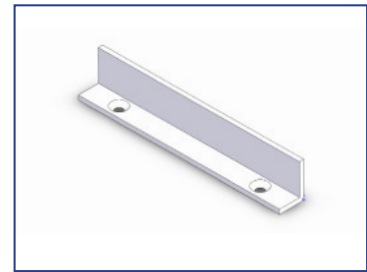

1014045 1" Jamb Clip



1014040 Feeler Gage

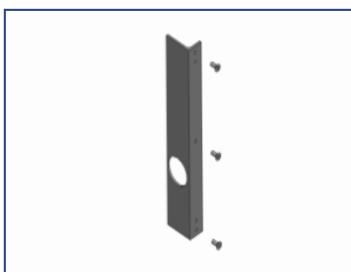

1014267 Internal Armoured Strike Kit

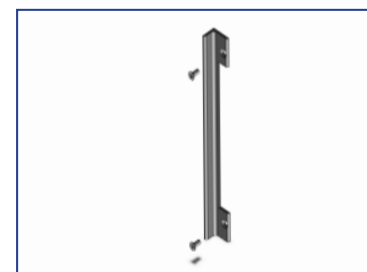

1014278 External Armoured Strike Kit



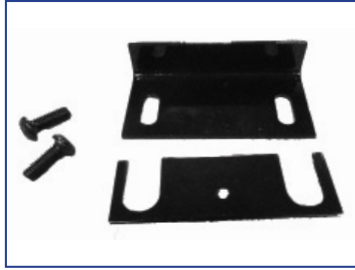

1013941 Carry Out Interlock Kit

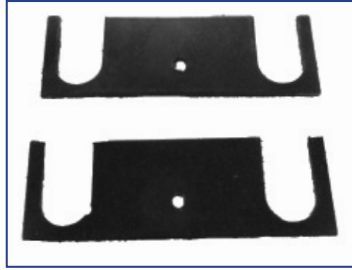

1013942 Carry Out Shim Kit



1013952 Telescopic Pulley Bracket A,
** Will replace 1010115

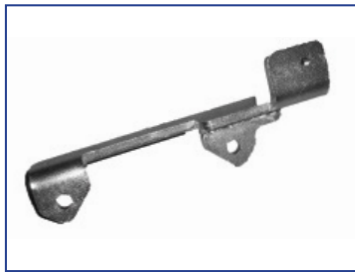

1013966 Telescopic Pulley Bracket B,
** Will replace 1010116

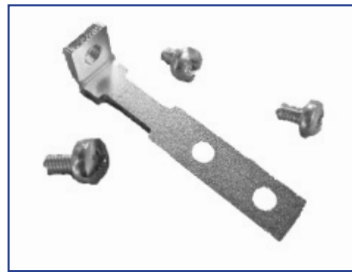

1013994 Carry Out Cover Latch
Bracket Assembly



1013984 Carry Out Cover
Latch Assembly

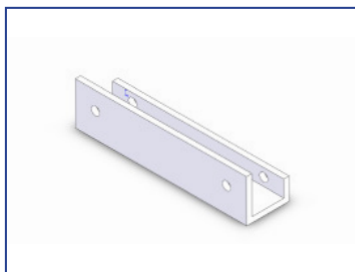

1014345 HPWB Switch Bracket

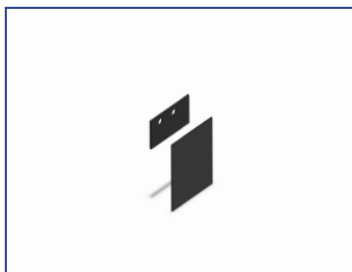

1014348 Rubber Cover Kit

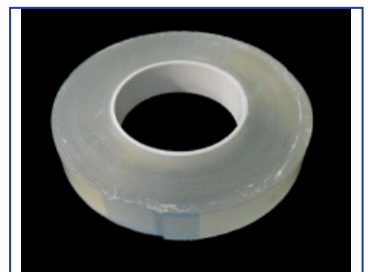

1014355 SA Beam Tape



Remember - search for all parts online at www.besam-usa.com

© ASSA ABLOY Entrance Systems US Inc.

T67

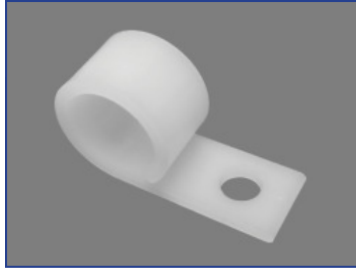

1702866 Wire Clip



1014026 Decal Kit



1014023 Decal, Automatic Door



1014022 Decal, Stand Clear



1014024 Decal, Emergency/
Right Arrow



1014025 Decal, Emergency /
Left Arrow



Add:
1013799 - Eccentric Anti-riser ass'y
1013934 - AR bar

TELESCOPIC

The global leader in door opening solutions



US05-0598-01 Telescopic Tensioner Assembly



1000290 Telescopic Wheel Stay Assembly

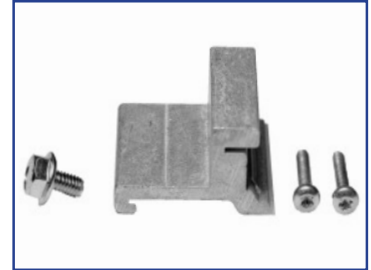

US05-0614-01 Telescopic Belt Anchor Assembly

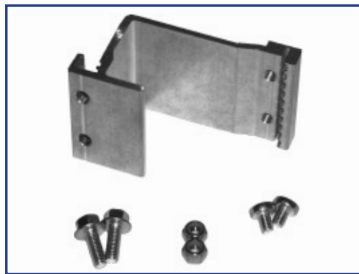

US05-0613-01 Telescopic Transfer Belt Assembly

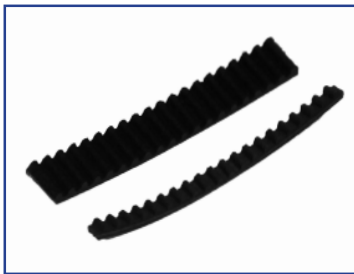

735351 Tooth Belt, Large, 9/16" x 6"



1000062 Tooth Belt, Small



US05-0612-01 Telescopic Track Support

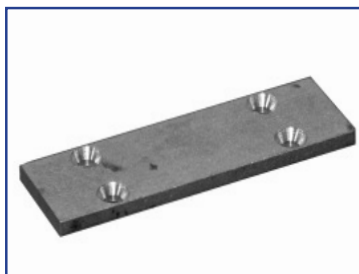

US04-0615-01 Telescopic Lower Edge Track Support

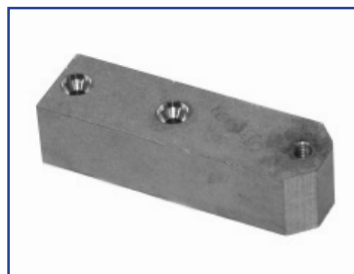

US04-0333-01 Non-Panic Hanger Block



US04-0332-01 Non-Panic Mounting Plate less screws



11-09-202 Screw for above



TELESCOPIC

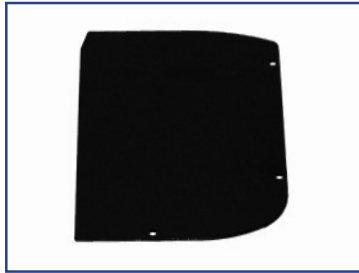

US04-0303-01 Telescopic
Endplate

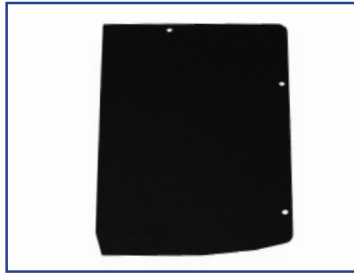

US04-0592-01 Telescopic
Endplate, Clad



CGL

The global leader in door opening solutions



US15-1550-01 PSA Assembly



US21-0587-01 Glass Clamp w/Dowel - Shown



US21-0587-02 Glass Clamp w/o Dowel

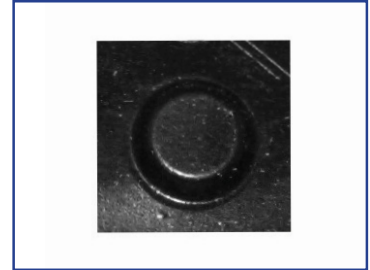

US20-0587-01 Glass Shim, Adhesive Back



US05-0549-01 Roller Guide Body Only



US15-0549-01 Complete Assembly



Roller Mounting Hardware Req'd:

55-09-018 Screw (2 ea)



19-09-004 Washer (2 ea)



04-09-548474 Nut (2 ea)

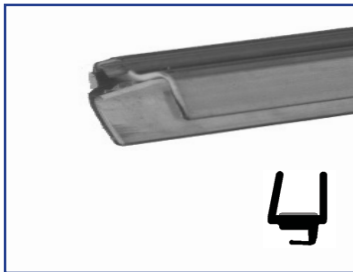

85-01-026 Acrylic Brushholder, Active Leaf

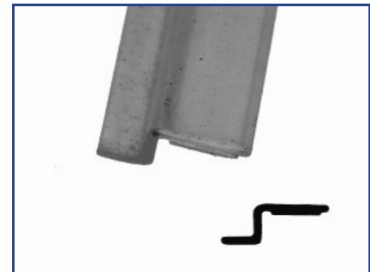

85-01-032 Acrylic Relief Strip, Sidelite



85-20-012 Lead Edge Weather Strip, Self Adhesive



85-20-022 Felt w/Strip, 1-1/4"



CGL

The global leader in door opening solutions



85-20-021 Felt w/Strip, Door, Vertical

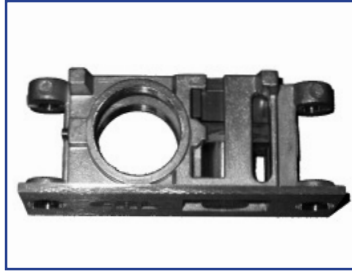

US08-0686-01 Lock Body, Shoe Only



Deadlock Mounting Hardware:

US09-0686-01 Screw (1 ea)



14-09-003 Lock Washer, M6, External Tooth (1 ea)



04-09-548474 Nut (1 ea)

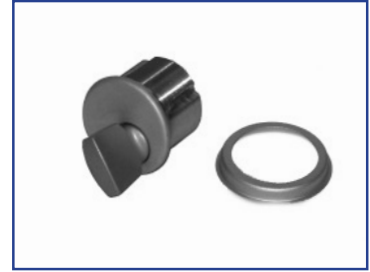

50-06-106 Thumb Turn, CL



50-06-109 Thumb Turn, BK



US06-1404-01 Key Cylinder, CL



US06-1404-02 Key Cylinder, BK



AMD Only

85-15-010 Bottom Guide FSL, LH

85-15-011 Bottom Guide FSL, RH

Obsolete



US09-0548-01 Endcap Screw



US04-0686-01 Lock Attachment Block



30-09-299 Set Screw



US03-0922-01 Guide Pin, CGL, Short (shown)



US03-0922-02 Guide Pin, CGL, Long



Remember - search for all parts online at www.besam-usa.com

© ASSA ABLOY Entrance Systems US Inc.



CGL Endcaps Standard:

US04-0548-07 Shoe A/L Top



US04-0548-08 Shoe A/L Top



US04-0548-11 Shoe 7" Bottom



US04-0548-12 Shoe 7" Bottom



US04-0548-15 Shoe 8" Bottom



US04-0548-16 Shoe 8" Bottom



US04-0548-19 Shoe 10" Bottom



US04-0548-20 Shoe 10" Bottom



CGL Endcaps Standard:

US04-0548-05 Shoe A/L Top



US04-0548-06 Shoe A/L Top



US04-0548-09 Shoe 7" Top/Bottom



US04-0548-10 Shoe 7" Top/ Bottom



US04-0548-13 Shoe 8" Bottom



US04-0548-14 Shoe 8" Bottom



US04-0548-17 Shoe 10" Bottom



US04-0548-18 Shoe 10" Bottom



UniSlide CGL Endcap Chart			
Standard Bottom/Top Rails LH		Standard Bottom/Top Rails RH	
Part Number	Application	Part Number	Application
US04-0548-05	5-1/2"	US04-0548-06	5-1/2"
US04-0548-07	5-1/2"	US04-0548-08	5-1/2"
US04-0548-09	7"	US04-0548-10	7"
US04-0548-11	7"	US04-0548-12	7"
Custom Bottom/Top Rails LH		Custom Bottom/Top Rails RH	
Part Number	Application	Part Number	Application
US04-0548-13	8"	US04-0548-14	8"
US04-0548-15	8"	US04-0548-16	8"
US04-0548-18	10"	US04-0548-17	10"
US04-0548-19	10"	US04-0548-20	10"



US05-0941-01 Pin Guide
Housing, CGL



CART

The global leader in door opening solutions



US02-0521-02 Base, 11 Pin



US02-0521-01 Interlock Interface

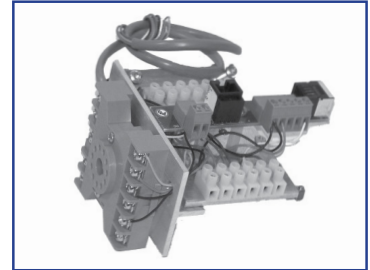

US05-0521-01 Interlock Interface, Assembly



US02-0527-01 Sensor, DH400



US21-0527-01 Subplate, DH400

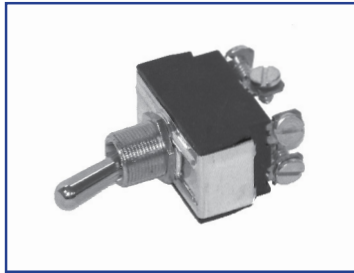

US15-0529-01 3-Position Switch Kit (DPDT), CL



US15-0529-02 3-Position Switch Kit (DPDT), BK



US02-0529-01 Switch Only

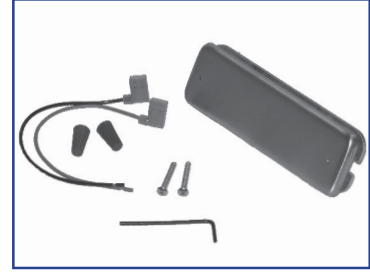

USPBJ10 Push Plates 1-1/2" x 4-3/4" Plain Face



US05-0519-02 Tandem Wheel



US04-0332-01 Non-Panic Mounting Plate less screws



11-09-202 Screw for above

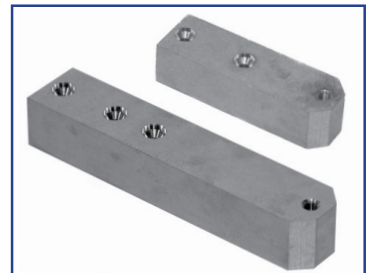

US04-0333-01 Hanger Block, Short



US04-0334-01 Upper Door Block, Long



CART

The global leader in door opening solutions



50-15-167 Non-Panic Guide

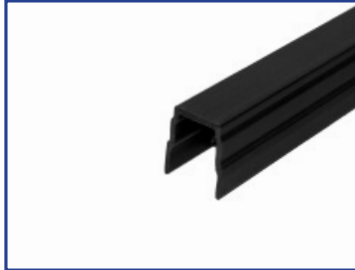

US21-0350-03 Fast Lock Channel, 4-1/2"



US09-0350-01 Fast Lock Spring, FSL



US04-0514-01 Spring Plate



50-06-173 Core, Best Lock w/B1 Key



50-06-174 Key, B1



50-06-175 Key, CT



US21-0350-01 Post, Fixed S/L, Fastlock



50-06-170 Cylinder, Best



50-06-161 Exit Indicator



50-04-HD3 Heavy-Duty Rod Guide



US08-0986-01 Sweep, 96", Surface Applied, Grey



Remember - search for all parts online at www.besam-usa.com

© ASSA ABLOY Entrance Systems US Inc.

CART

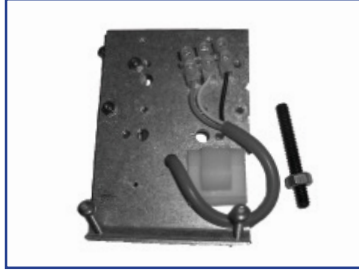

US15-0382-01 Kit, Door Position Switch, LH

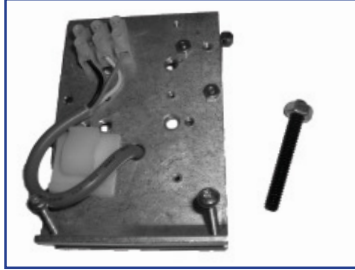

US15-0382-02 Kit, Door Position Switch, RH



RESILIENCE

The global leader in door opening solutions



US03-0671-01 Steel Interlock, S/L
Obsolete

65-09-004 Screw



Use the above interlocks for product produced prior to March 2011, otherwise use kit US15-1613-01 on page 4.



US03-0671-02 Steel Interlock, A/L
Obsolete

50-09-HD1CL Screw



US15-0434-01CL Interlock Set, CL



US15-0434-01BK Interlock Set, BK



Replaces US15-0538 series



US04-0537-02 Spring Guide Block



US04-0641-01 Guide Block Shim



40-09-200 Screw, 1/4-20 x 3/8"



52-09-004 Screw, 1/4-20 x 1"



US04-0537-01 Lock Rod Guide Block



US04-0641-01 Guide Block Shim



40-09-200 Screw, 1/4-20 x 3/8"



52-09-004 Screw, 1/4-20 x 1"



US05-0626-01 Lock Pin Assembly



US03-0626-01 Bushing



RESILIENCE

The global leader in door opening solutions



US05-0636-01 Lock Strike Assembly



US03-0664-01 Ball Detent Plate, FBO - OBSOLETE

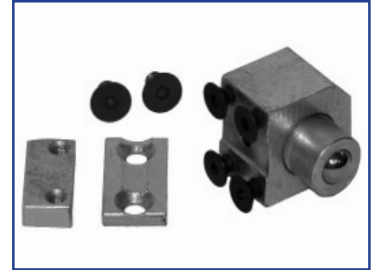

50-05-006 Ball Detent Kit, FBO



US03-0638-01 Lock Plate, Hurricane



US08-0651-01 Lock Body, 31/32" (Includes Bottom Lock Rod)



50-06-110/HD Lock Rod Assembly, 3-Point Converter



50-06-106 Thumb Turn Cylinder, CL



50-06-198/KA Cylinder, Keyed, CL



50-06-132/FB Faceplate, Flush, BK/BK Fuzz



50-06-109 Thumb Turn Cylinder, BK



50-06-199/KA Cylinder, Keyed, BK



50-06-131/FB Faceplate, Flush, CL/BK Fuzz



Remember - search for all parts online at www.besam-usa.com

© ASSA ABLOY Entrance Systems US Inc.

RESILIENCE

The global leader in door opening solutions

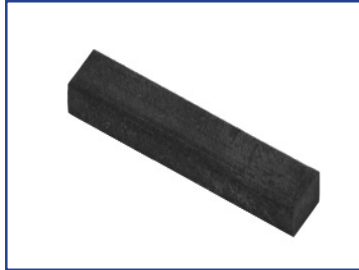

US20-0660-01 Glass Block, 1/4" x 1/2"



US15-0277-03 Kit, Base Plate Assembly, Bottom Pivot

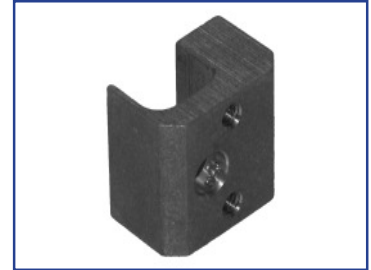

US04-0663-01 Pivot Block Shim



40-09-200 Screw, 1/4-20 x 3/8"

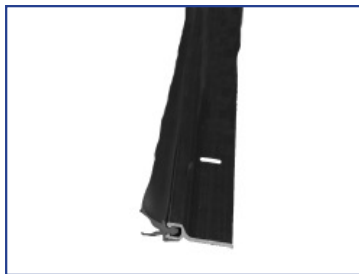

US15-0659-01 Door Sweep 48", CL



50-20-HD187DB Weather Brush



50-20-6402 Pile Vertical, Rail, NS, BK



US15-0659-02 Door Sweep 48", BK



53-20-001 Vinyl Pull-In Glazing Obsolete



US20-0213-01 Vyram Rubber Glass Bead



53-20-002 Vinyl Roll-In Glazing Obsolete

RESILIENCE

The global leader in door opening solutions



US04-0801-01 Threshold Guide



US05-0796-04 Guide Pin Assembly

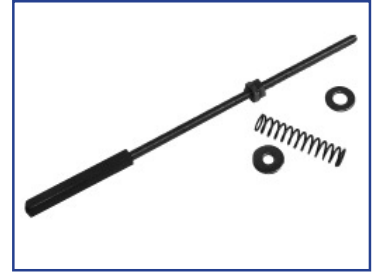

US05-1630-01 Spring Rod Assembly, G86



US05-1695-01 Ball Catch Kit, A/L Door, Hurricane

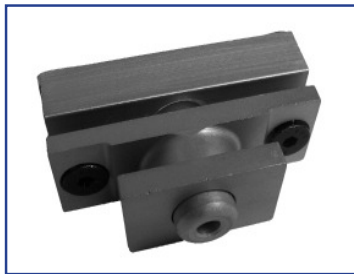

US05-1695-02 Ball Catch Kit, S/L Door, Hurricane



US15-1613-01 Interlock Kit, Dade



US21-0797-01 Pin Guide Washer, Resilience



Remember - search for all parts online at www.besam-usa.com

© ASSA ABLOY Entrance Systems US Inc.



US15-1500-08 Retrofit Kit, UniSlide,
5 Position Switch
**May require additional parts for some
applications (i.e., remote mount, over size doors)



US15-1500-09 Retrofit Kit, UniSlide,
5 Position Key Switch
**May require additional parts for some
applications (i.e., remote mount, over size doors)



**** Note: multiple cables can be connected to achieve desired length****

JAMB MOUNTED
PROGRAM SELECTORS

The global leader in
door opening solutions

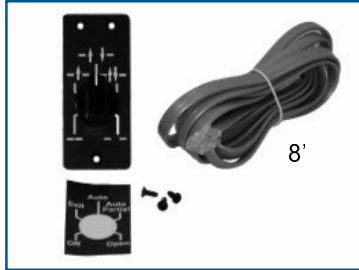

US15-1500-04 5-Position
Switch Kit, Knob
• Order with US15-1500-01 if retrofitting
UniSlide to jamb switch
• Kit includes one 8' cable

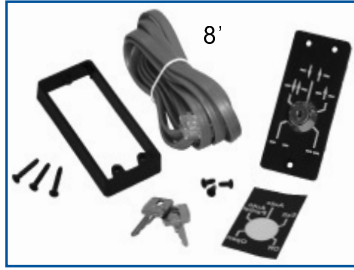

US15-1500-06 5-Position
Switch Kit, Key
• Order with US15-1500-01 if retrofitting
UniSlide to jamb switch
• Kit includes one 8' cable



US15-1500-05 3-Position
Switch Kit, Knob
• Order with US15-1500-01 if retrofitting
UniSlide to jamb switch
• Kit includes one 8' cable

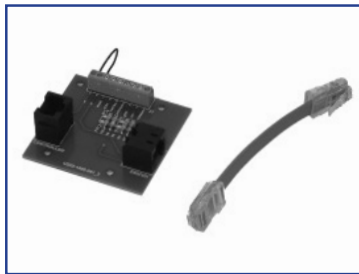

US15-1500-01 PS Accessory
Board Kit
• Required for any switch to interface
with UniSlide control
• Accessory board is mounted next to
control to provide plug-in interface

Replaced by 1011621



US15-1500-03 Spacer Kit,
Switch



US15-1500-07 Switch Kit,
Remote Box
• Order when switch is being remote
mounted



US02-0314-08 Cable, Switch, 3"

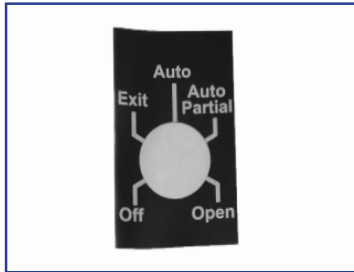

US24-1500-51 Decal with Text



75-09-101 Replacement Key,
5-Position Switch



Remember - search for all parts online at www.besam-usa.com

© ASSA ABLOY Entrance Systems US Inc.



75-20-001 Knob, Position Switch



US15-1500-02 Cable Kit, Overheight Extension
• Multiple cables can be connected to achieve desired length.**



1000478 Filler Plate, Blank Plate
• Order when blank filler plate is desired to fill PS-5R opening



1009426 Kit, Accessory Board

Superseded by 1011621

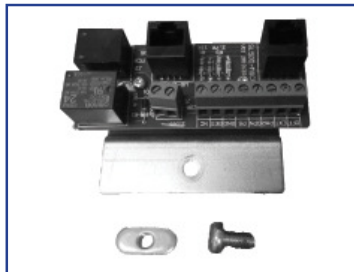

1011621 Unislide Mode Selector Connection Board w/ cable (Metal Bracket)



POWER-GLIDE

The global leader in door opening solutions



04-02-655500R Control, AMD I, Rebuild

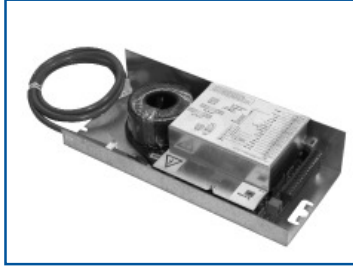

655711R Control, CUD9, 120V AMDII, Rebuild



549712R Motor Gear, AMD II, Rebuild

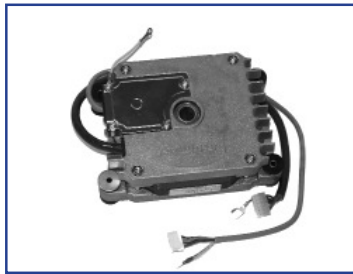

04-15-549664R Motor, w/RC, AMDI (Small Pulley, 1.5"), Rebuild



04-02-655128R Power Supply, 10 Amp, AMD/EMD , Rebuild



04-02-654509B PMD Programming Unit



04-02-654509R Rebuilt



04-15-549043 Coverlock



550191 Idler Pulley



POWER-GLIDE

The global leader in door opening solutions

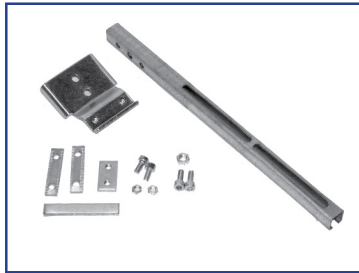

04-15-548732 Drive Bar Kit, Single Slide **OBSOLETE**

04-15-548731 Drive Bar Kit, Bi-part **OBSOLETE**



735351 Belt, Toothed, 9/16" x 6", TPI

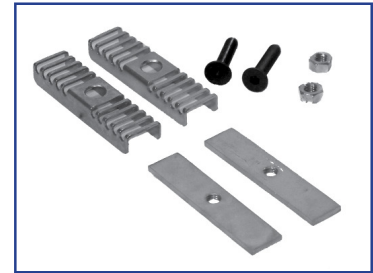

549855 - **OBS** replaced by 2 of 548786-1

548786-1 Belt Clamp Kit (2 required to replace 549855 shown above)

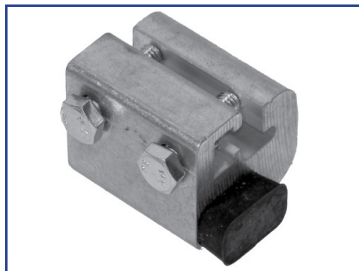

04-05-832372 Stop, Full Open w/ Bumper



16-20-106 Door Stop, Rubber



04-15-832440 Anti-Rise Wheel Assembly



04-15-832376 Guide Wheel Assembly

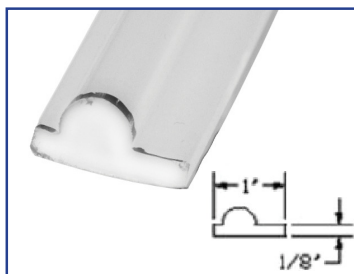

04-21-701239 Track, Extrusion, Roller, AMD/EMD, Per Foot

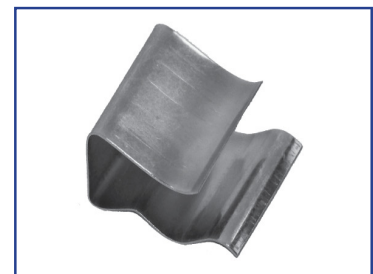

04-03-544958 Clip, Retaining, HD Track



Remember - search for all parts online at www.besam-usa.com

© ASSA ABLOY Entrance Systems US Inc.

POWER-GLIDE



50-15-137 Bottom Roller Assembly, Active Leaf



50-15-475 Pin Guide Track, 48"



50-15-475L Pin Guide Track, 96"

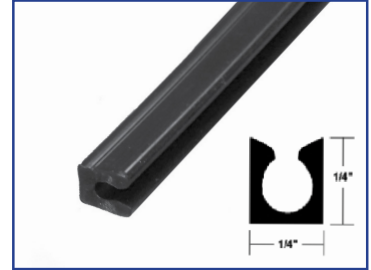

50-20-135 Track Cap, Extrusion, Pin Guide Track Insert, Per Foot

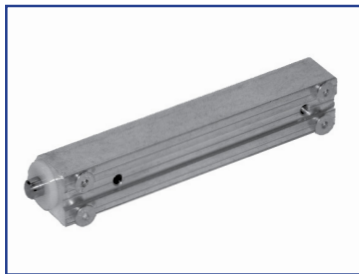

US15-0435-01 Spring Pin Guide Assembly, FBO, CL



50-21-002 Spacer, FBO Guide

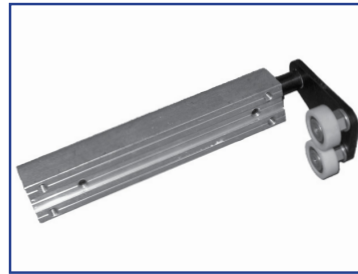

US15-0644-02 Roller Guide Assembly, FSL

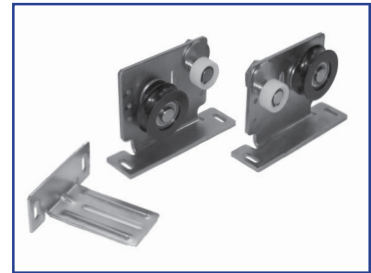

04-15-548377 Wheel Carriage Kit w/Hardware

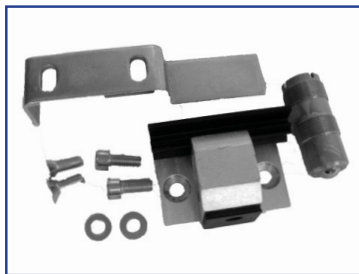

50-15-416 Assembly, AMD Ball Catch, A/L, Black



50-15-417 Assembly, AMD Ball Catch, A/L, Clear



04-02-692065 Lock Kit, Electric, AMD/EMD-2, Fail/Safe, Bi-Part ONLY, Rebuild



04-02-692068 Lock, Electric, AMD-RH, EMD-LH, Fail/Safe - OBSOLETE

04-02-692069 Lock, Electric, AMD-LH, EMD-RH, Fail/Safe - OBSOLETE

POWER-GLIDE

The global leader in door opening solutions

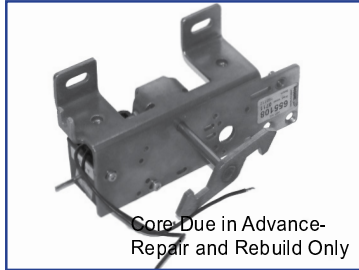

04-02-692064 Lock Kit, Electric, AMD/EMD-2, Fail Secure, Bi-Part ONLY, Rebuild



04-02-692066 Lock, Electric, AMD-RH, EMD-LH Fail Secure, **OBSOLETE**

04-02-692067 Lock, Electric, AMD-LH, EMD-RH, Fail Secure, **OBSOLETE**

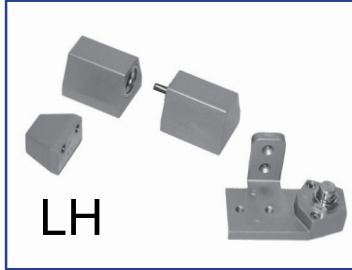

50-15-560SCL Offset Pivot Kit, RH, CL, w/Hardware



50-15-560SDB Offset Pivot Kit, RH, BZ, w/Hardware



50-15-561SCL Offset Pivot Kit, LH, CL, w/Hardware



50-15-561SDB Offset Pivot Kit, LH, BZ, w/Hardware



04-03-654423 Lock Fitting, AMD/EMD



50-20-6402 Pile Vertical, Rail, NS, BK



US20-0213-01 Vyram Rubber Glass Bead



US21-0327-03 Endcap, Door Carrier - US21-0327-02 **OBSOLETE** Use US21-0327-03



US20-0327-02 Cushion, End Cap



Remember - search for all parts online at www.besam-usa.com

© ASSA ABLOY Entrance Systems US Inc.

POWER-GLIDE

4000

ASSA ABLOY

The global leader in
door opening solutions



18-02-001R Control, C Series, Rebuilt



14-02-003R Power Supply, C Series, Rebuilt



14-02-004R Terminal Board, Aluminum Box, Rebuilt

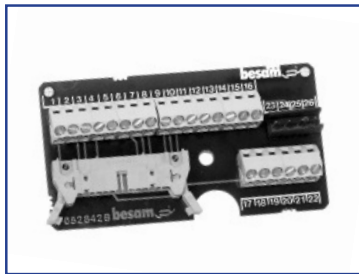

19-02-022R Terminal Board (Only), C Series, Rebuilt



19-05-005R Gearbox, PG 4000C, Rebuilt



18-05-001R Gearbox, EZ4050C, Rebuilt



18-15-106 Motor, C Series, w/RC



18-15-106R Motor less coupling, Rebuilt



19-02-020 Harness, Rev Counter, 4050C, 2500mm

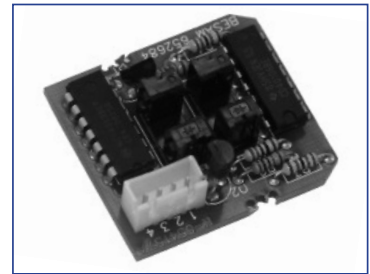

14-02-006R Rev Counter, 3000/4000C, Rebuilt

When Exhausted use **30-02-652684**



phone: 888-732-3726

parts.na.besam@assaabloy.com

fax: 800-304-9459

© ASSA ABLOY Entrance Systems US Inc.

POWER-GLIDE

ASSA ABLOY

4000

The global leader in door opening solutions



20-20-203 Coupling Spider



18-03-016 Roller Assembly w/Bracket **OBSOLETE**



18-03-018 Roller and Shaft Assembly



19-03-007 Roller, C Tandem

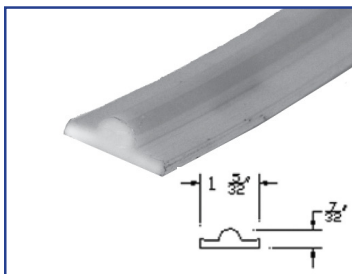

18-20-002 Track, C Series



19-15-020 Stop Kit, Open - **OBSOLETE**



16-20-106 Door Stop, Rubber



18-20-004 Tooth Belt



18-03-019 Sprocket, Drive Belt w/Key



Remember - search for all parts online at www.besam-usa.com

©ASSA ABLOY Entrance Systems US Inc.

POWER-GLIDE

ASSA ABLOY

The global leader in
door opening solutions

4000

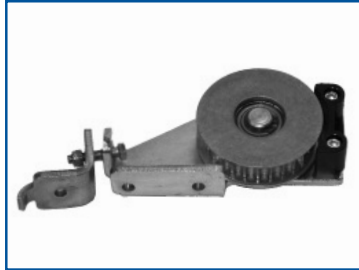

19-03-002 Sprocket, Idler
Obsolete



19-05-008 Belt Bracket,
Complete - **Obsolete**



18-15-016 Belt Bracket, 4050
Complete
Obsolete



19-03-003 Belt Bracket, Tooth
Portion



18-03-009 Belt Bracket,
Locking Plate-
Obsolete



18-02-005 Harness, Ribbon
Cable to Terminal Box



Power-Glide

ASSA ABLOY

3000 - A & B

The global leader in
door opening solutions



11-02-100R Motor, B Series,
w/o Rev. Counter, Rebuilt



11-02-103 Brush, Motor



11-02-110R Rev. Counter,
B Series, Rebuilt



11-04-150 Pulley, Idler for Belt



11-04-140 Sprocket, Drive
Belt, 3000B



USLO75 Belt, 3/4", BK



11-04-851 Roller, Antiriser,
Complete, 3000B



11-04-850 Roller, Complete
w/Small Axle Stud, 3000B



11-04-856 Roller for Track
Repair Kit



****Note: Limited quantities available. Please consult Service Parts for availability****

phone: 888-732-3726

parts.na.besam@assaabloy.com

fax: 800-304-9459

© ASSA ABLOY Entrance Systems US Inc.

Power-Glide

ASSA ABLOY

3000 - A & B

The global leader in
door opening solutions



11-04-180 Drive Arm w/Spider,
3000B



10-20-001 Coupling, Spider,
3000B/C



20-20-203 Coupling Spider



50-21-0901 Guide, Bottom,
FBO, Foot only



50-01-063 Track, Bottom
Guide, Foot Style, FBO, 55", CL



11-04-105R Gearbox, 3000B/C,
Rebuild



Note: Limited quantities available. Please consult Service Parts for availability.

Remember - search for all parts online at www.besam-usa.com

© ASSA ABLOY Entrance Systems US Inc.

TABLE OF CONTENTS

Automatic Swing Doors

- Handing Guide
- SW200i
- SW100
- SwingMaster 900
- SwingMaster MP
- Swingmaster
- PowerSwing
- Ready-Fold
- Navig-aider - No Longer Supported
- Electra 150 - No Longer Supported

SWING DOOR HANDING GUIDE

The global leader in
door opening solutions

EXTERIOR



RIGHT HAND
INSWING



RIGHT HAND
OUTSWING



LEFT HAND
INSWING



LEFT HAND
OUTSWING

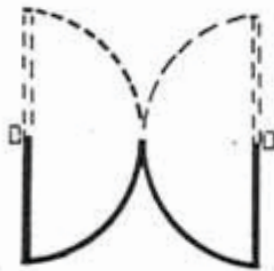

PAIR SIMULTANEOUS
INSWING



PAIR SIMULTANEOUS
OUTSWING

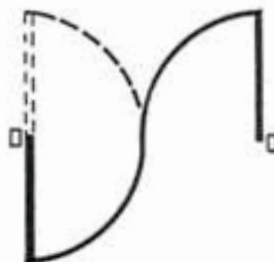

PAIR EGRESS

BESAM SW200i

ASSA ABLOY

The global leader in door opening solutions



331007291 Operator Assembly (NEW) - Core Required



1007315 Motor only- (NEW) Core Required



331009105 Encoder Cable

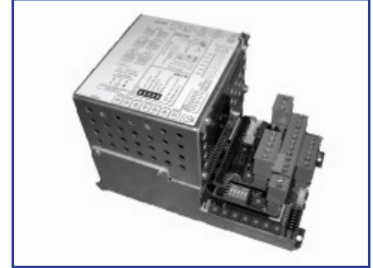

331008346 Control Unit w/ EXU Boards installed (Only configuration available) - (NEW) Core Required



1007756 Oval Nut



723178 Screw



1009344 Cable, SW100/SW200i SP52-BA, PNP (Top)



1009329 Cable, SW100/SW200i SP52-OP, PNP (Bottom)



1003582* 3-Position Rocker Switch Kit (shown)



* Items are backward compatible with SW100



1003583* Sync Harness for Pairs



1007478 Battery Back-Up Kit



33738753 Single Battery Kit



655845 PS-4C Switch



BESAM SW200i

ASSA ABLOY

The global leader in door opening solutions

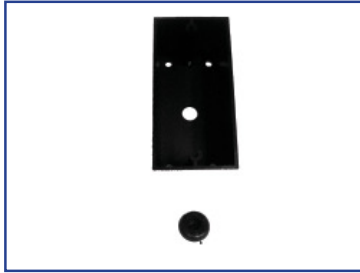

655806 Surface Mounted Box

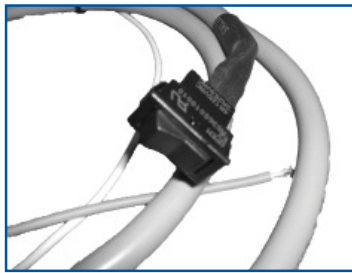

330000330 Rocker Switch Kit, PCD



330000331 Battery Extension Cable Kit



1008552 Conversion Kit, ,Dual Door CPD



1009132BK End Plate Kit, Black (Old style-Rounded cover)



1009132SI End Plate Kit, Silver (Shown)



1009450BK End Plate Kit, Black, Shown (Chamfer cover)



1009450SI End Plate Kit, Silver



US15-0805-01 Kit,Back Rail Cover Assy,CL

US15-0805-02 Kit,Back Rail Cover Assy,DB



1009960 Micro Switch & Cam Kit (includes Signal Cable)



330000276 Stop Arm Kit (includes Door Stop & Block)



Remember - search for all parts online at www.besam-usa.com

© ASSA ABLOY Entrance Systems US Inc.

BESAM SW200i

ASSA ABLOY

The global leader in
door opening solutions



331007327 Mounting (Fixing) Kit, SA



331007504 Connection Box



1007241BK Push Arm Assembly, Black



1007241SI Push Arm Assembly, Silver (Shown)



1007247BK PAS Arm, Right Assembly, Black



1007247SI PAS Arm, Right Assembly, Silver (Shown)



1007476BK PAS Arm, Left Assembly, Black



1007476SI PAS Arm, Left Assembly, Silver (Shown)



1007251BK Pull & Offset Pivot Arm Assembly, Black (Shown)



1007251SI Pull & Offset Pivot Arm Assembly, Silver



330000271BK Push Arm Service Kit, Black



330000271SI Push Arm Service Kit, Silver



1008396BK Extension Kit, 20MM, with 10MM Bolt, Black (Shown)



1008396SI Extension Kit, 20MM, with 10MM Bolt, Silver

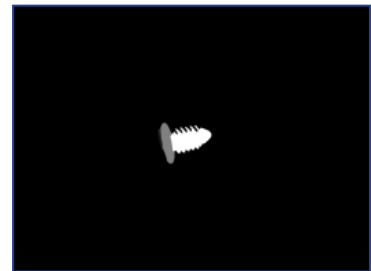

1702165 Hole Plug, End Cap, BL



331007323 replaced by
330000276 on pg 2.

BESAM SW200i

ASSA ABLOY

The global leader in door opening solutions



1008398BK Extension Kit, 50MM, with 10MM Bolt, Black (Shown)



1008398SI Extension Kit, 50MM, with 10MM Bolt, Silver



1008400BK Extension Kit, 70MM, with 10MM Bolt, Black (Shown)



1008400SI Extension Kit, 70MM, with 10MM Bolt, Silver

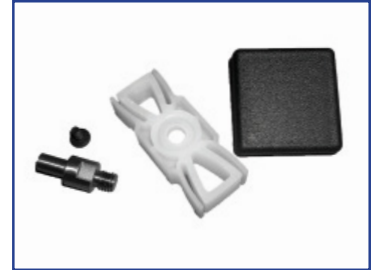

330000272BK Pull/PAS Arm Service Kit, Black



30000272SI Pull/PAS Arm Service Kit, Silver



330000270BK Adaptor Kit, with 10MM Bolt, Black only



1007531 Detachment Guard for Cover



1010668 Fold, Shaft Ext. Kit



1010931-1 OS Seal, Short Piece, CL



1010931-2 OS Seal, Short Piece, DB



1010931-3 OS Seal, Short Piece, ML



1010549 OHC Short Arm & Hdwe Kit - SHOWN



1012328 OHC DBO Arm/Hrdwr Kit



1702178 OS Header/Door Seal with Hardware, CL



1702181 OS Header/Door Seal with Hardware, DB



1702182 OS Header/Door Seal with Hardware, MF



Remember - search for all parts online at www.besam-usa.com

© ASSA ABLOY Entrance Systems US Inc.

OHC

The global leader in door opening solutions



1010668 Shaft Extension Kit, 5/8", OHC, S/A for 6X6 Header- includes bolt - **was 1008596**



1010090 Outswing Door Stop Kit, Black



1009791 Extension Kit, 16MM for Offset Pivot Arm



1009345 Arm Kit, OHC



1008600 Panic Breakout Device, OHC



1009036 Clamp & Bolt Kit, Retrofit & Bottom Load



1008614 Bracket Kit, OHC, Junction Box



1009607 Clamp & Bolt Kit (OHC, Offset Pivot, SA 6X6, Readyfold)



331008610 Micro Switch, OHC



US15-0805-01 Kit, Ball Rail Cover Ass'y, CL



US15-0805-02 Kit, Ball Rail Cover Ass'y, DB



OHC

The global leader in door opening solutions

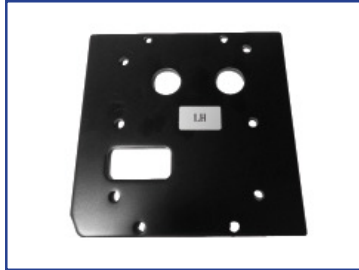

1008595BK OHC 6x6 End Cap Black, LH SHOWN



1008595SI OHC 6x6 End Cap Silver, LH

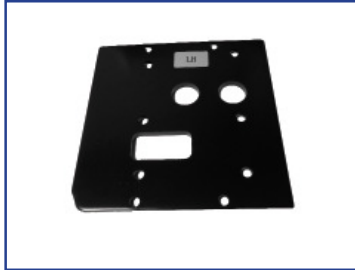

1008611BK SW200i-OS End Cap, Black, LH SHOWN



1008611SI SW200i-OS End Cap, Silver, LH

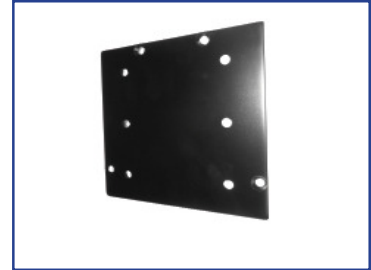

1008612BK SW200i-BL End Cap, Black SHOWN (1701932 Screw)



1008612SI SW200i-BL End Cap, Silver (1701704 Mtg Screw)

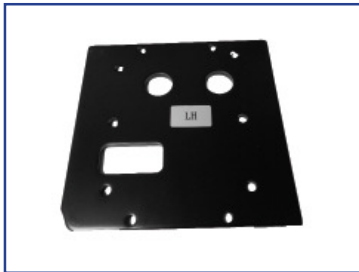

1009195BK SW200i-SA 6x6 End Cap Black, LH SHOWN



1009195SI SW200i-SA 6x6 End Cap, Silver, LH

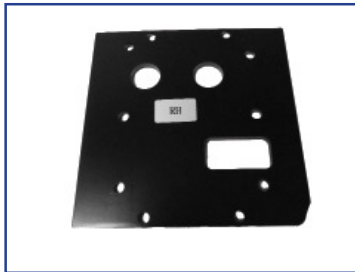

1009277BK SW200i-OHC 6x6 End Cap Black, RH SHOWN



1009277SI SW200i-OHC 6x6 End Cap Silver, RH

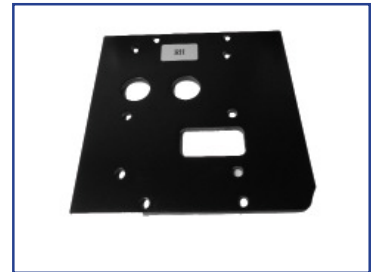

1009278BK SW200i-OS End Cap Black, RH SHOWN



1009278SI SW200i-OS End Cap Silver, RH



1009279BK SW200i-SA 6x6 End Cap, Black, RH SHOWN



1009279SI SW200i-SA 6x6 End Cap, Silver, RH



1009602 M6 Slot Nut, OHC



1009230 Modernization Kit for Stanley, Horton, and SM900, OHC



Remember - search for all parts online at www.besam-usa.com

© ASSA ABLOY Entrance Systems US Inc.

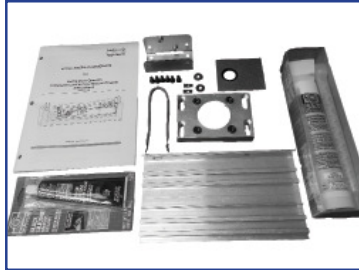

1010273 Opcon Pivot Assembly Kit

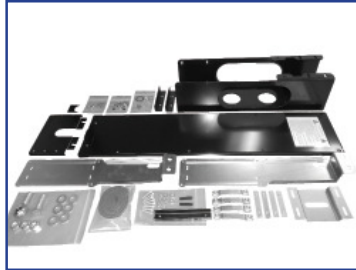

1010267 Modernization Kit



1010055 Output Adaptor Kit -25MM



1010337 Output Adaptor Kit -40MM



1010815 Output Adaptor Kit -54MM



1010059 Output Adaptor Kit -57MM



1009473 Output Adaptor Kit -63MM



1010696 Output Adaptor Kit -66MM



1010697 Universal Output Adaptor Kit



1009408 Arm Door Bottom Kit





1701884 Seal, IG



1701862 Bearing, IG



1009548 Silicone RTV, Black



1009419 Gasket, Enclosure
Cover

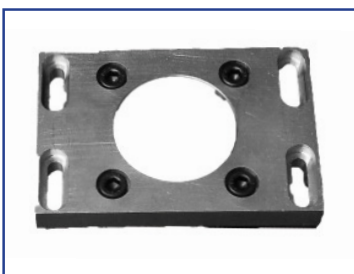

1009537 Pivot Assembly,
Output

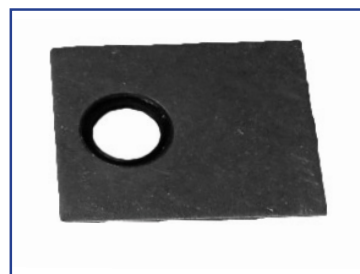

1009631 Seal Assembly

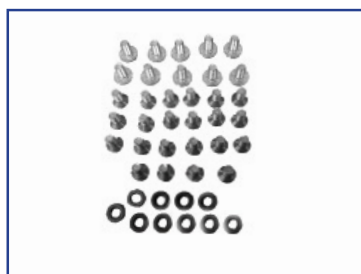

1011663 Cover Screw Kit



Remember - search for all parts online at www.besam-usa.com

© ASSA ABLOY Entrance Systems US Inc.

Modernization Chart

The global leader in door opening solutions

SW200i Modernization Service Part Numbers

Baan Part number	Description	SW200i Basic	Accessories (Push Plates)
		SW200iUPGD	SW200iUPGDACC
1007300	Operator,SW200i w/Control	1	
1009230	Retrofit kit assembly	1	
*Select from bill of materials list	Backplate, header and endplates	Optional (1)	
1007241SI or 1007241BK*	Arm Asy,SW200i Push Outswing	1	
1007476SI or 1007476BK or 1007247SI or 1007247BK*	Arm Asy,Pull Inswing		
1009345	Arm, Kit OHC		
1003582 or 75-15-310*	Switch, ON/OFF/HOLD OPEN	1	
1003583	Sync Cable	1 (pair only)	
USTD433PB9V	Transmitter,433 freq. w/9V Bat		2
USRD433	Receiver, 433 freq.		1
1008061	Push Plate,4 3/4"Square,PTO HC		2
USBBOXSQ475FM	Push Plate Box,Sq Flush Mount		2
USBBOXSQ475SM	Push Plate Box,Sq Surf Mount		
1008396SI or 1008396BK*	Shaft,Ext, 20mm ,W/Scr&Slv	Optional (1)	
1008398SI or 1008398BK*	Shaft,Ext, 50mm ,W/Scr&Slv		
1008400SI or 1008400BK*	Shaft,Ext, 70mm ,W/Scr&Slv		
1009960	Lock Kick Microswitch and Cam Kick	Optional (1)	

Sensor Options			
Baan Part Number	Description	A202	A101 & A102
1708968	A202 Optex Pro Swing Elite sensor kit	1 Per Door leaf	
1701733 & 1701739	Sensor, SP32 DMPS & Additional head (Optex)		Optional (1 each)
1009329	Besam, SP33, PNP Cable (OPTEX)		Optional (1 each)
US02-0274-15	Sensor, SP52 DMPS 42" (BEA)		
1009344	Besam, SP52 PNP Cable (BEA)		
1701737	Besam SA31-OP Motion Sensor (Optex)	Optional (1)	Optional (1)
US02-0274-06	Besam SA51-BA Motion Sensor (BEA)	Optional (1)	Optional (1)
1701732	Besam SP34-OP, Frame Mount OPS (Optex)		Optional (1 Each)
1701735	Besam SP34-OP, PNP cable (Optex)		
1701734	Besam SP34-Op, Mount (Optex)		Optional (1)
US02-0274-02	Besam SP53-BA Frame Mount OPS (BEA)		Optional (1)
US02-0274-04	Besam SP53-Mount (BEA)		Optional (1)

SW100

ASSA ABLOY

The global leader in
door opening solutions

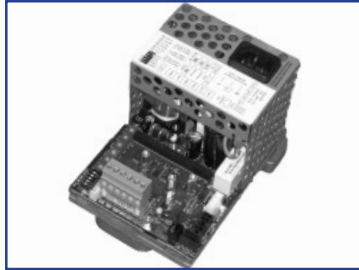

1003532 Control Unit



1003532R Control Unit, Rebuilt

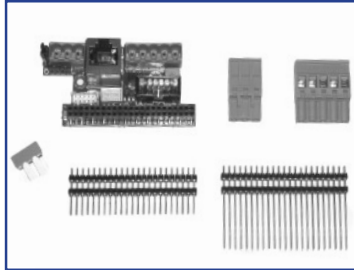

1003557 Safety Kit, EXU-SA
***Use with door mounted
safety sensor and relay output
for door/error indication.

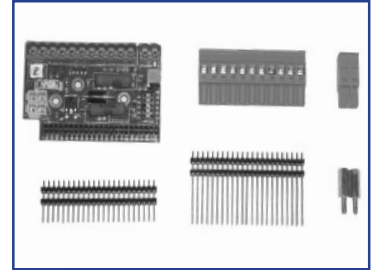

1003554 Security & Impulse
Kit, EXU-SI
***Use with battery back-up,
electric lock and open/close
ratchet impulse.



1003567 Battery Assembly
w/Cables



1003581 2-Position Rocker
Switch Kit



1003582 3-Position Rocker
Switch Kit (shown)



1003583 Sync Harness for Pairs



1003498 Gearbox/Motor



1003498R Gearbox/Motor, Rebuilt



33000233 Encoder Cable

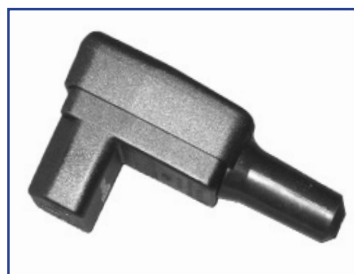

1700607 CU Plug



1003542 Endcap Cover



1003543 Endcap Backplate



phone: 888-732-3726

parts.na.besam@assaabloy.com

fax: 800-304-9459

© ASSA ABLOY Entrance Systems US Inc.

SW100

ASSA ABLOY

The global leader in door opening solutions



1006506 PS Endcap Kit



173004BK Extension Bar, 230mm, BK (was 21-06-173004)



173005BK Extension Bar, 345mm, BK (was 21-06-173005)

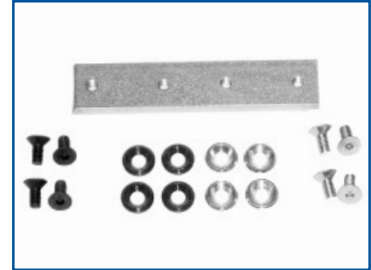

173191 Extension Connector (was 21-06-173191)



1007241BK Arm Assembly, Push, Outswing, BK



1007241SI Arm Assembly, Push, Outswing, Silver



1007251BK Arm Assembly, Pull, Inswing, BK



1007251SI Arm Assembly, Pull, Inswing, Silver



173775 End Cap



1004897 Arm, Adapter Ext, PSW



21-03-205 Shaft Extension, 20mm



21-03-206 Shaft Extension, 50mm



21-03-207 Shaft, Extension, 70mm



330000227 Arm Adapter Kit



US21-0323-01 Strain Relief, Plastic, 3/8"

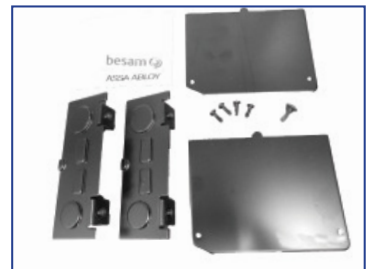

1009792 End Plate Kit PS/SW100



Remember - search for all parts online at www.besam-usa.com

© ASSA ABLOY Entrance Systems US Inc.

SW100

ASSA ABLOY

The global leader in door opening solutions

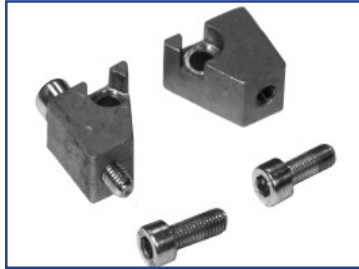

1006512 Door Stop Block Kit



(was 1006510)

330000230 Door Stop Kit

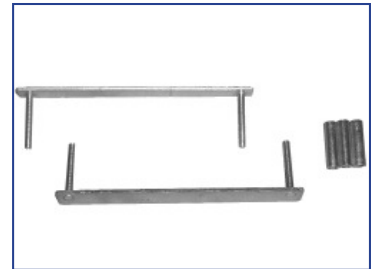

1006504 Transmission Fixing Kit



US04-1402-3925CL PS Cover, 39.25", CL



US04-1402-3925DB PS Cover, 39.25", DB



US04-1402-51CL PS Cover, 51", CL



US04-1402-51DB PS Cover, 51" DB



US04-1402-99CL PS Cover, 99", CL



US04-1402-99DB PS Cover, 99", DB



US04-1402-13CL PS Cover, 13' CL



US04-1402-13DB PS Cover, 13' DB



-13CL / DB are non-stock items with 3 week leadtime.

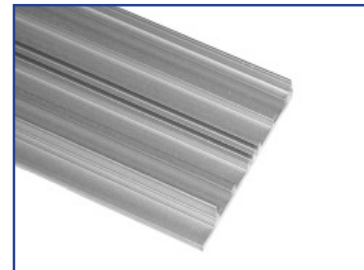

US04-0505-3925CL PS Back Plate, 39.25", CL



US04-0505-3925DB PS Back Plate, 39.25", DB



US04-0505-51CL PS Back Plate, 51", CL



US04-0505-51DB PS Back Plate, 51", DB



US04-0505-99CL PS Back Plate, 99", CL



US04-0505-99DB PS Back Plate, 99", DB



US04-0505-13CL PS Back Plate, 13', CL



US04-0505-13DB PS Back Plate, 13', DB



















phone: 888-732-3726

parts.na.besam@assaabloy.com

fax: 800-304-9459

© ASSA ABLOY Entrance Systems US Inc.

SW100 Sales thru Service Parts

Baan Part Number	Barcodes	Description	SW100 Basic	SW100 w/Safety	Accessories (Push Plates)
			SW100 UPGD	SW100 UPGD SAFE	SW100 UPGD ACC
1006841 + Header**		Operator, w/Control	1	1	
1007241BK		Arm Assembly, Push, Outswing	1	1	
1007251BK		Arm Assembly, Push, Inswing			
1004897		Arm Adapter Extension	1	1	
1003582		Switch, ON/OFF/HOLD OPEN	1	1	
US15-0138-02		Decal Kit, Low Energy Stock	1	1	
1003557		Safety Kit		1	
US02-0274-21		Sensor, BEA SuperScan I, 42"		1	
USTD433PB9V		Transmitter, 433 Freq. w/9V Bat			2
USRD433		Receiver, 433 Frequency			1
USPBS1		Push Plate, 4-3/4" Square, HC			2
USBBOXSQ475FM		Push Plate Box, Sq Flush Mount			2
USBBOXSQ475SM		Push Plate Box, Sq Surf Mount			
21-03-205		Shaft Ext, 20mm, w/Screw & Slv	Optional (1)	Optional (1)	
21-03-206		Shaft Ext, 50mm, w/Screw & Slv			
21-03-207		Shaft Ext, 70mm, w/Screw & Slv			

****FOR HEADER ASSEMBLIES SEE NEXT PAGE**

Remember - search for all parts online at www.besam-usa.com

© ASSA ABLOY Entrance Systems US Inc.

****Header Assemblies:**

US05-0809-01 39-1/4", Clear



US05-0810-01 39-1/4", Dark Bronze



US05-0804-01 51", Clear



US05-0805-01 51", Dark Bronze



US05-0806-01 99", Clear



US05-0807-01 99", Dark Bronze



SWINGMASTER® 900

ASSA ABLOY

The global leader in
door opening solutions



Operator:

US05-0583-11 OHC Spring #1



US05-0583-12 OHC Spring #2



US05-0583-11R OHC Spring #1,
Rebuilt



US05-0583-12R OHC Spring #2,
Rebuilt



US05-0583-10R OHC 405, RH
(Readyfold ONLY), Rebuilt



Operator:

US05-0583-21 Surface Mounted
Spring #1



US05-0583-22 Surface Mounted
Spring #2



US05-0583-21R Surface
Mounted, Spring #1, Rebuilt



US05-0583-22R Surface
Mounted, Spring #2, Rebuilt



US05-0583-20R OHC 405, LH,
(Readyfold ONLY), Rebuilt



US15-0583-20 Motor Assembly,
w/Coupling



30-02-173663R Motor Assembly,
wo/Coupling



US02-0583-01 Control, CU2



US02-0583-01R Control, Rebuilt



US02-0583-02 Plug-n-Play
Module, CUHub

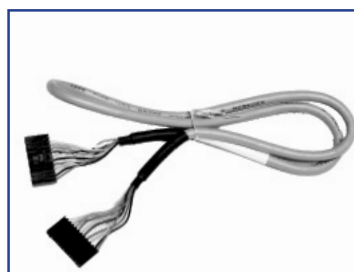

US02-0583-05 Harness, Hub
to CU2 Control



US02-0583-04 Harness,
Operator Switch



phone: 888-732-3726

parts.na.besam@assaabloy.com

fax: 800-304-9459

© ASSA ABLOY Entrance Systems US Inc.

1 Rev B

SWINGMASTER® 900

ASSA ABLOY

The global leader in
door opening solutions



US02-0583-14 Harness, CU2
Sync Cable 5'



US02-0583-08 Harness, CU2
Activation Sensor



US02-0583-11 Harness, CUHub
Overhead Presence Sensor



US02-0583-09 Harness,
CUHub Overhead Presence
Sensor for Double Egress



US02-0583-10 Harness, CUHub
Door Mounted Sensor

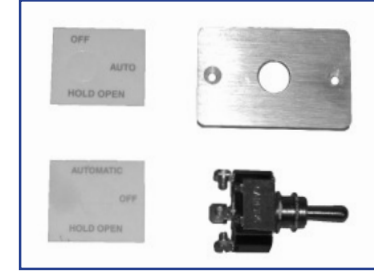

75-15-310 3-Position Toggle
Switch Kit, CL



75-15-311 3-Position Toggle
Switch Kit, DB



US02-0583-13 3-Position
Toggle Switch, Plug-n-Play,
CUHub

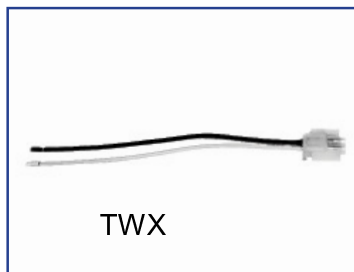

TWX

US02-0583-18 2-pin Harness,
120V, Male - (**Terminate when
Exhausted**)

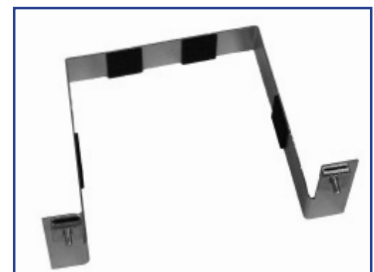

US15-0583-18 Controller Strap
w/Hardware



Remember - search for all parts online at www.besam-usa.com

© ASSA ABLOY Entrance Systems US Inc.

SWINGMASTER® 900

ASSA ABLOY

The global leader in
door opening solutions



US03-0579-01 Cam Backcheck, CU2, Top

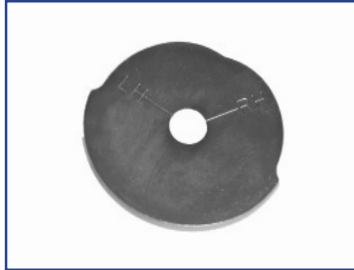

US03-0579-02 Cam, CU2 Home, Bottom

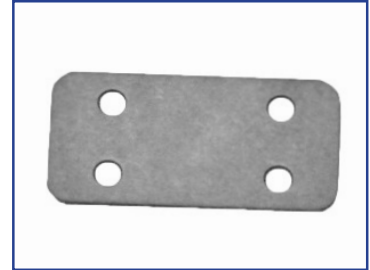

30-20-205 Spacer, Switch



30-02-200 Short Arm Microswitch



US02-0583-06 Long Arm Microswitch



US21-0583-01 Microswitch Adaptor

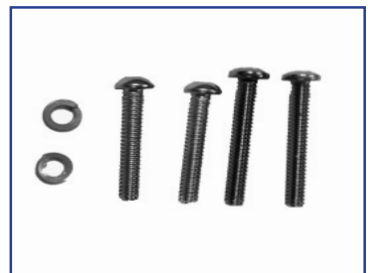

30-09-268 Long Microswitch Screw (1 ea)



30-09-219 Small Microswitch Screw (1 ea)



US02-0583-16 Fuse, 2A, 250V

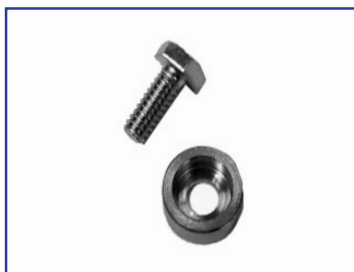

21-09-004 Cam Bolt



30-03-173652 Cam Spacer



US09-5202-01 Split Washer (1 ea)



SWINGMASTER® 900

ASSA ABLOY

The global leader in
door opening solutions



US15-0583-11 CUP to CU2
Single Kit (SHOWN)



US15-0583-12 CUP to CU2
Pair Kit

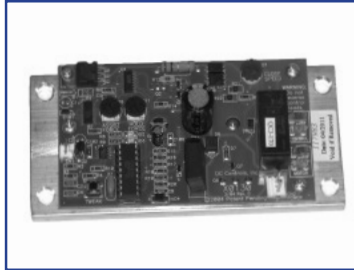

US02-0583-17 Power Close
Module, XO130



US02-0583-19 Push and Go
Module, 10PUSHNGO

Remember - search for all parts online at www.besam-usa.com

© ASSA ABLOY Entrance Systems US Inc.

MP

The global leader in door opening solutions

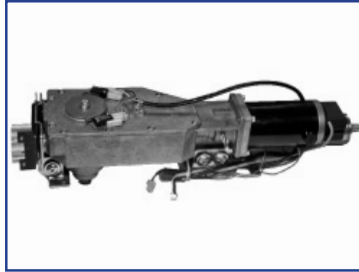

30-10-100106R MP Surface Mounted, Rebuilt

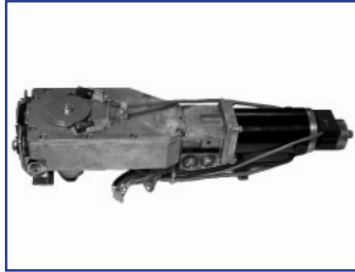

30-10-100092R MP Overhead Concealed, Rebuilt



30-15-173664 Motor Encoder Assembly, Complete



30-15-173664R Rebuilt

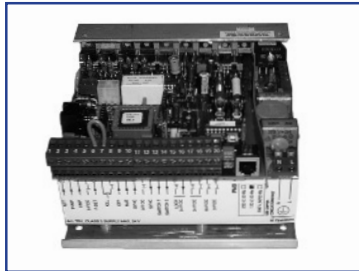

30-02-655449R Control Unit, CUP, 120V, Rebuilt Only

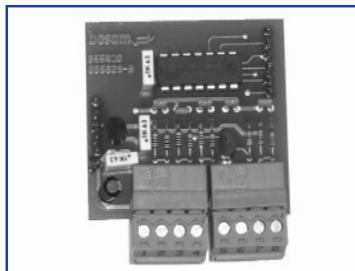

30-02-655630 EXS Expansion Module/CUP

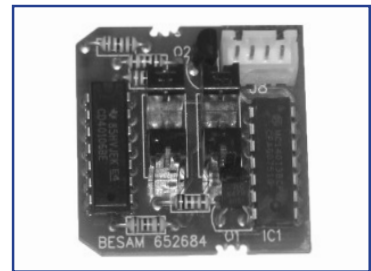

30-02-652684 MP Encoder Board

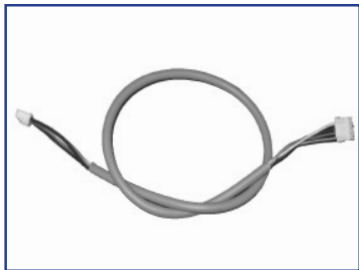

30-02-655635 MP Harness, Encoder Cable

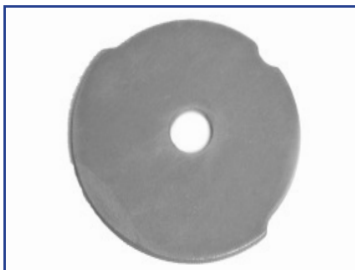

30-03-173651 MP Cam



30-02-709091 MP Microswitch





30-02-655455 Harness, Cam Switch



30-02-600126 Programmable Battery Back-up Control, 120V
****Limited Quantities****



30-02-654745 Battery Pack, 12V



30-04-735334 Coupling, MP Series



US02-0583-16 Fuse, 2AMP



713983 Fuse, 10AMP



04-02-654509B PMD Unit



04-02-654509R PMD Unit, Rebuilt



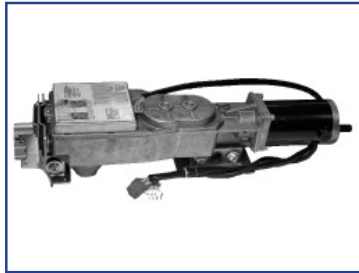

Rebuilt Operators:

30-10-051R 350, S/MT, RH, Rebuilt



30-10-051RL 350, S/MT, LH, Rebuilt



35-10-051R 450, S/MT, RH, Rebuilt



35-10-052R 450, S/MT, LH, Rebuilt



35-10-053R 455, S/MT, RH, Rebuilt



35-10-054R 455, S/MT, LH, Rebuilt

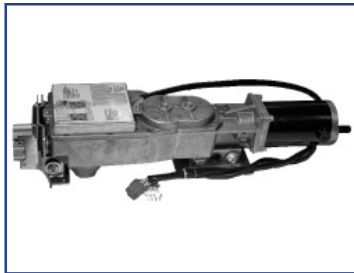

Rebuilt Operators:

30-10-001R 300, OHC, RH, Rebuilt



35-10-001R 400, OHC, RH, Rebuilt



35-10-002R 400, OHC, LH, Rebuilt



35-10-003R 405, OHC, RH, Rebuilt



35-10-004R 405, OHC, LH, Rebuilt



30-10-001RL 300, OHC, LH, Rebuilt



30-10-002R 305, OHC, RH, Rebuilt



30-02-101 Motor, SM, 90VDC



30-02-101R Motor, Rebuilt



30-15-221 B Switch w/Cam



30-15-011 PC Board Assembly,
Dual - **Obsolete**

30-15-011R PC Board, Rebuilt



US05-0496-02 PC Board,
Heavy Duty, Dual, 850

Obsolete

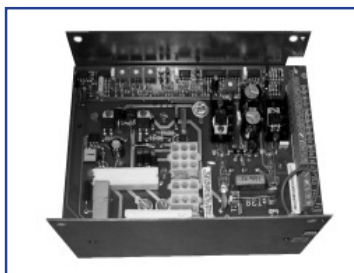

30-15-010 PC Board Assembly,
Single - **Obsolete**

30-15-010R PC Board, Rebuilt



US05-0496-01 PC Board,
Heavy Duty, Single, 850

Obsolete



30-04-214 Panic Switch, Cam
- **Obsolete**

SWINGMASTER

ASSA ABLOY

The global leader in door opening solutions



30-02-223 Harness, Switch, Ext12", 400 Series, Red



30-02-224 Harness, Switch, Ext 60", 400 Series, Red



30-02-209 Harness, Motor, Ext. 60", White



30-02-210 Harness, Motor, Ext. 12", White



30-02-211 Harness, Motor, Ext.12", 300 Series, White



30-02-213 Harness, Motor, Ext.60", 300 Series, White



30-02-203 Harness, Switch, SM 300, Operator



30-02-241 Harness, 120V, Female, 2-pin -

OBSOLETE

US02-0583-18 Harness, 120V, Male, 2-pin - **Terminate when exhausted**



US21-0583-01 Microswitch, Backcheck Adaptor



30-20-205 Switch Spacer



US02-0583-06 Microswitch, Long Arm



30-02-200 Microswitch, Short Arm



Remember - search for all parts online at www.besam-usa.com

© ASSA ABLOY Entrance Systems US Inc.



75-02-154 Fuse, 7 AMP



21-02-010 Fuse, 1.5 AMP

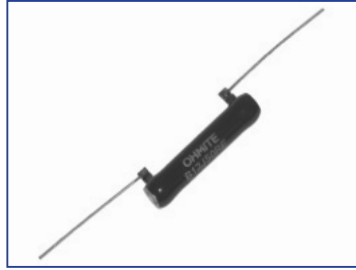

30-02-010 Resistor, 175 Ohm, Light Duty



30-02-011 Resistor, 82 Ohm SM Closing



30-02-260 Resistor, 50 Ohm 12W



30-02-204 Relay, 12V/DC, 5-Pin, ETIK

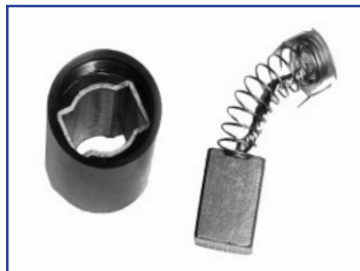

30-02-216 Brush (Only), Motor, 90V/180V



30-02-231 Complete Assembly



30-04-225 Coupling, 300 Series

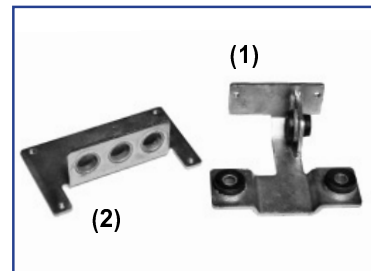

30-04-005 Mount, Operator, Hinge Side (1)



30-04-006 Mount, Operator, Hinge Side (2)



30-05-001 Mount, Operator



32-09-112 Spacer, Operator Mount



30-15-217 Rack Stop Assembly

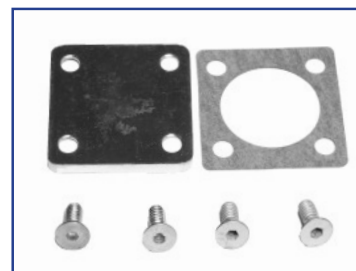

30-15-216 Rack Gear Stop Kit



SWINGMASTER

ASSA ABLOY

The global leader in
door opening solutions

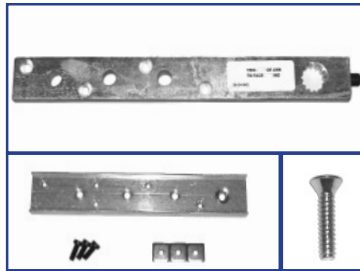

30-06-101 Arm, Center Pivot Assembly w/Label & Set screw (top view)



50-15-114 Center Pivot Arm Spacer Kit (bottom left)



50-09-142 Screw (bottom right)



NOTE: Order EACH of the above to get ENTIRE Top Door Arm Assembly. 4 of the 50-09-142 are required for entire assembly.



30-06-102 Outswing Arm, Standard Assembly, Complete, CL



30-06-217 Outswing Arm, Standard Assembly, Complete, BK



30-06-103 Inswing Arm Assembly, RH, CL, Complete



30-06-226 Inswing Arm Assembly, RH, BK, Complete



30-06-104 Inswing Arm Assembly, LH, CL, Complete



30-06-215 Inswing Arm Assembly, LH, BK, Complete



PPB-15-850RCL Arm Assembly, RH, Inswing, CL

PPB-15-850LCL Arm Assembly, LH, Inswing, CL

Obsolete



30-15-202 Shaft Adapter Kit



30-06-208 Rod, Male End, CL



30-06-221 Rod, Male End, BK



Remember - search for all parts online at www.besam-usa.com

© ASSA ABLOY Entrance Systems US Inc.



30-06-209 Door Bracket Arm (Shoe), CL



30-06-222 Door Bracket Arm (Shoe), DB



30-15-228 Shaft Extension, 1-3/4"



30-15-245 Shaft Extension, 3-1/2"



30-15-246 Shaft Extension, 5"



30-06-202 Guidetrack, Inswing, Standard, Complete, CL



30-06-236 Guidetrack, Inswing, Standard, Complete, BK

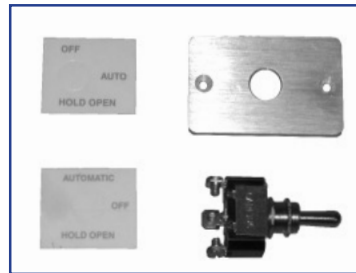

75-15-310 3-Position Toggle Switch Kit, CL



75-15-311 3-Position Toggle Switch Kit, DB



30-15-224 Inswing Roller Kit



30-06-201 Rod, Connecting, 350, Arm, 12-1/4", CL



30-06-112 Rod, Connecting, 350 Arm, 12-1/4", BK



30-06-110 Rod, Connecting, 350 Arm, 14-1/4", CL



30-06-113 Rod, Connecting, 350 Arm, 14-1/4", BK



30-06-107 Rod, Connecting, 350 Arm, 16-1/4", CL



30-06-114 Rod, Connecting, 350 Arm, 16-1/4", BK



30-06-109 Rod, Connecting, 350 Arm, 18-1/4", CL



30-06-115 Rod, Connecting, 350 Arm, 18-1/4", BK



SWINGMASTER

ASSA ABLOY

The global leader in
door opening solutions



35-15-202 Mounting Kit, SM
Op 350/450



35-03-001 Bracket, Top
Stabilizer



30-15-211 Kit,Mounting,SM
Op,300/400



Remember - search for all parts online at www.besam-usa.com

© ASSA ABLOY Entrance Systems US Inc.

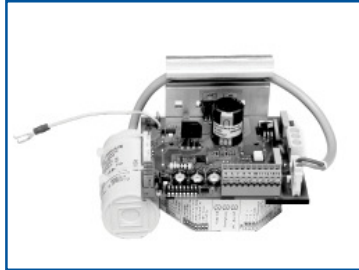

1004204 Control Board, CSDB



1004204R Control Board, CSDB, Rebuilt



1701510 Connector, 6-Pin for new version control for 2014



* Refer to Technical Bulletin M155 for additional information

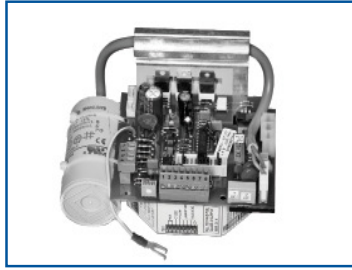

600085R Control Board, CSDA, Rebuilt

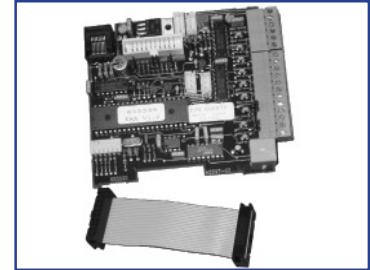

600075 Extension Board, EXA

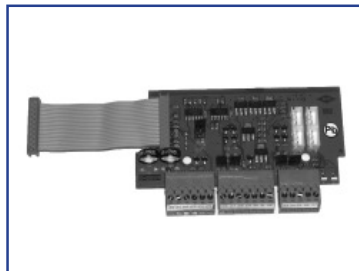

1004116 Extension Board, EXB



1004117 3-Position Rocker Switch, CSDB



600080 3-Position Rocker Switch, CSDA

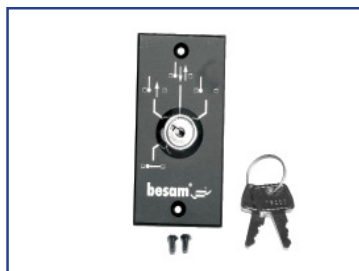

655845 4-Position Switch w/key, EXA & EXB

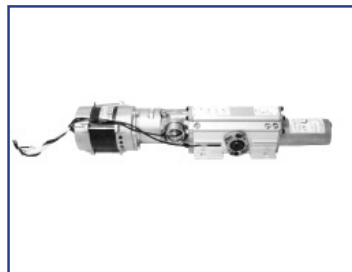

173721 Operator Assembly, 110V



173721R Operator Assembly, 110V, Rebuilt



173711 Motor, 120V



173711R Motor, 120V, Rebuilt





655580 Terminal Block



655614 Limit Switch



1004205 Limit Switch, 78-3/4"
Cable



656064 Slave Cable Kit



173653 Cable Holder



714254 Fuse 0.5AT Slow, 120V



715236 Fuse 10ATH Slow, 120V



21-06-173383 Push Arm
System, Hybrid, BK
(Replaced by 1007241BK)

21-03-010 Arm Shaft, Spindle



173099 Standard Push Arm
System, BK

Same Screw in **330000227**

(Replaced by **1007241BK**
plus adapter **1004897**)



1003576BK Arm Assembly, Push,
Outswing, BK

(Replaced by 1007241BK)

Must use with 1004897



Obsolete

100125BK Pull Arm System, BK

(Replaced by **1007251BK** plus
adapter **1004897**)

Remember - search for all parts online at www.besam-usa.com

© ASSA ABLOY Entrance Systems US Inc.



Must use with 1004897

1003577BK Arm Assembly, Pull, Inswing, BK
(Replaced by 1007251BK)

173775 End cap for above



1004897 Arm, Adapter Extension, PSW

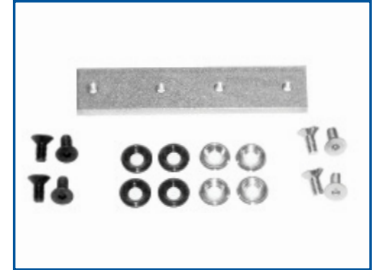

173191 Extension Connector



173804BK Spacer, Reveal, Pull Arm
(Replaced by 1014317BK)

1014317BK Spacer, Reveal, Pull Arm, Black



21-03-205 Shaft, Extension, 20mm, w/Screw and Sleeve



21-03-206 Shaft, Extension, 50mm



21-03-207 Shaft, Extension, 70mm

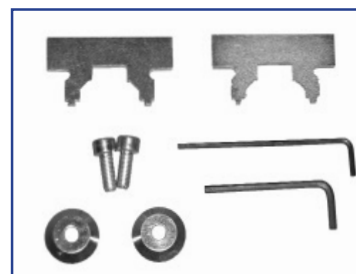

173719 Tool Direction Change



173004BK Extension Bar, 230mm, Black



173004SI Extension Bar, 230mm, Silver





173005BK Extension Bar, 345mm, Black



173005SI Extension Bar, 345mm, Silver

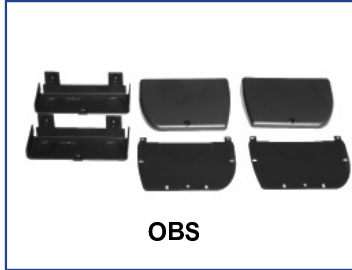

OBS

US15-0800-02 Header Kit - OBSOLETE

Use SW100/PS - 1006506

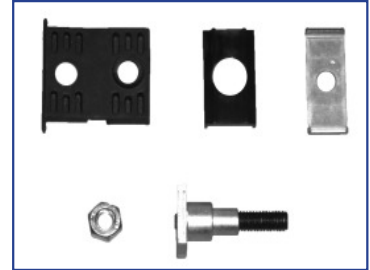

US15-0801-01 Mounting Post



US15-0270-01 Mounting Hardware Kit for 6" Header



US03-0270-01 Mounting Bracket

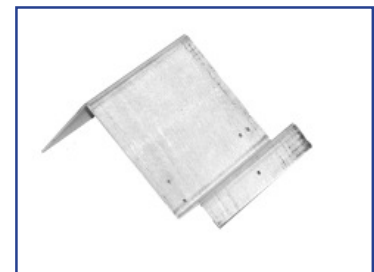

US04-0270-01 Mounting Bracket for Control



21-15-012 Mounting Kit for 6" Header Case



100147 Door Stop



Remember - search for all parts online at www.besam-usa.com

© ASSA ABLOY Entrance Systems US Inc.



US05-0583-10R Operator, OHC 405, RH, Rebuilt



US05-0583-20R Operator, OHC 405, LH, Rebuilt



US05-0583-12R Operator, OHC Spring #2, Rebuilt*



NOTE:

Refer to the appropriate Swingmaster section for all other operators and controls.

OHC 405 springs are used for Ready-Fold Infold applications.

***OHC spring #2 is used for Ready-Fold Outfold applications.**



55-15-120 Bearing Pivot
Assembly, Carrier



55-15-121 Bearing Pivot
Assembly, Double



55-15-122 Bearing Pivot
Assembly, Single



55-15-123 Shaft Pivot
Assembly, LH, (Shown)



55-15-124 Shaft Pivot
Assembly, RH



55-03-040 Shaft, Long, Top
Pivot

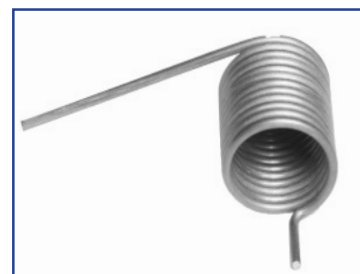

55-03-055 Spring, Torsion, RH



55-03-056 Spring, Torsion, LH



55-04-096 CUP, Spring



55-09-045 Washer, Thrust

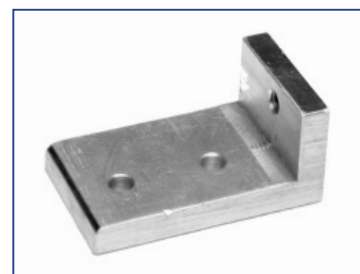

55-04-075 Angle Mounting
Bracket Carrier



Remember - search for all parts online at www.besam-usa.com

© ASSA ABLOY Entrance Systems US Inc.

READY-FOLD®

ASSA ABLOY

The global leader in
door opening solutions



55-09-027 Pin, Retaining,
1/8" x 1"



US15-0513-01 Wheel Roller
Kit, DHD



55-15-345 Kick-Off Assembly

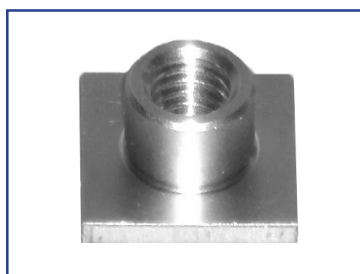

55-03-042 Insert, Roller, Carrier



55-03-017 Slide Block Screw



55-21-023 Block Stop w/Screw



Kits include mtg hdwe

US01-0460-LLCL Track Only, 48", CL



US01-0460-LLDB Track Only, 48", DB



55-15-012DB Guidetrack Kit, 48", DB



55-15-012 Guidetrack Kit, 48", CL



50-15-114 Arm Spacer Kit,
Center Pivot



phone: 888-732-3726

parts.na.besam@assaabloy.com

fax: 800-304-9459

© ASSA ABLOY Entrance Systems US Inc.

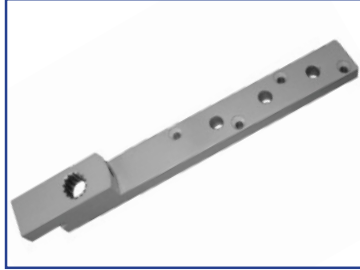

55-03-010 Drive Arm Assembly, Unfinished



55-03-010BL Drive Arm Assembly, BK



55-03-010CL Drive Arm Assembly, CL

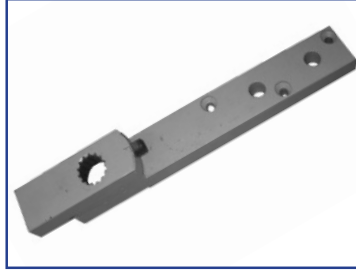

55-15-085 Drive Arm Assembly, Unfinished



55-15-085BL Drive Arm Assembly, BK



55-15-085CL Drive Arm Assembly, CL



50-15-0005 Pivot Kit, Bottom Swing Door



55-15-016 Cable, Male, Door Portion



US20-0227-01 Finger Guard, 8', BK



55-15-018 Cable, Female Header/Jamb

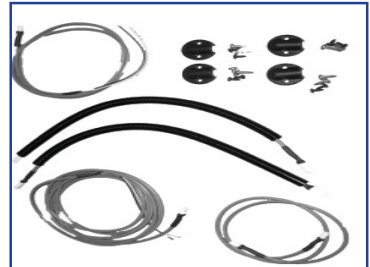

1009213 Kit, Cable, RF Doors



55-15-015 Assembly, Roller & Insert, RF



Remember - search for all parts online at www.besam-usa.com

© ASSA ABLOY Entrance Systems US Inc.

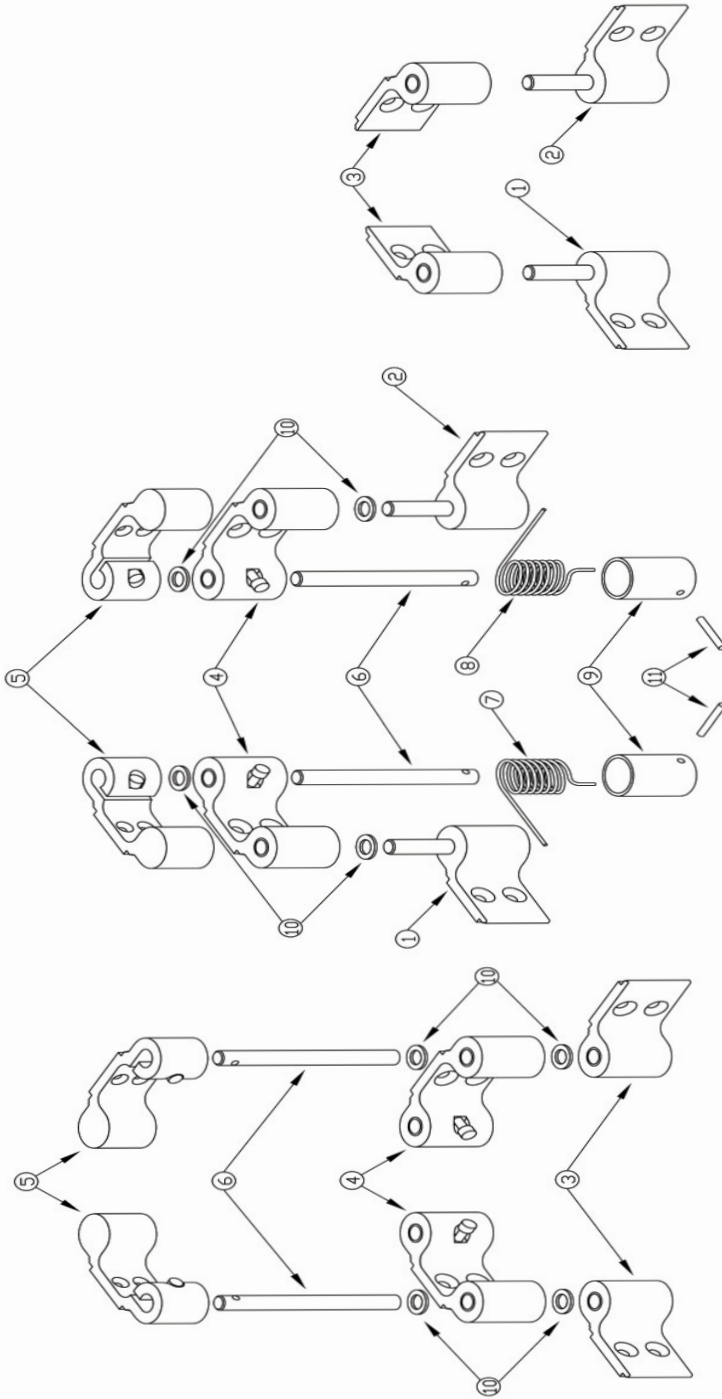

LEFT AND RIGHT IN/OUT FOLD
READY FOLD LOWER HINGE ASSEMBLY
NOTE: BI-WAY UPPER & LOWER HINGE ASSEMBLY

LEFT AND RIGHT IN FOLD
READY FOLD UPPER HINGE ASSEMBLY

LEFT AND RIGHT OUT FOLD
READY FOLD UPPER HINGE ASSEMBLY

ITEM	DESCRIPTION	ASSY/PART #
1	ASSY, SHAFT PIVOT, LH	55-15-123
2	ASSY, SHAFT PIVOT, RH	55-15-124
3	ASSY, BEARING PIVOT, SINGLE	55-15-122
4	ASSY, BEARING PIVOT, DOUBLE	55-15-121
5	ASSY, BEARING PIVOT, CARRIER	55-15-120
6	SHAFT, LONG	55-03-040
7	SPRING, TORSION, RH	55-03-055
8	SPRING, TORSION, LH	55-03-056
9	CUP, SPRING	55-04-096
10	WASHER, THRUST	55-09-045
11	PIN, RETAINING	55-09-027

TABLE OF CONTENTS

ASSA ABLOY

The global leader in
door opening solutions

VersaMax/ICU

- ICU Handing Guide
- VersaMax
- VersaMax ICU Touchless
- VersaMax ICU Swing Package
- VersaMax ICU Swing Package Anti-Microbial
- VersaMax Fold
- ICU/CCU Smoke Seal Chart
- ICU/CCU
- ICU/CCU Telescopic
- Bi-Way

FBO TELESCOPIC SINGLE SLIDE

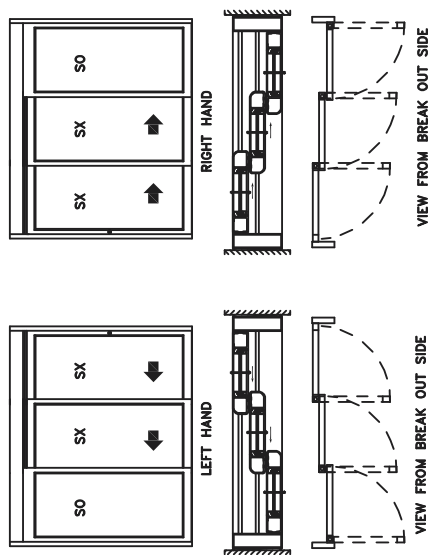

BI-WAY ICU FOLDING SINGLE SLIDE

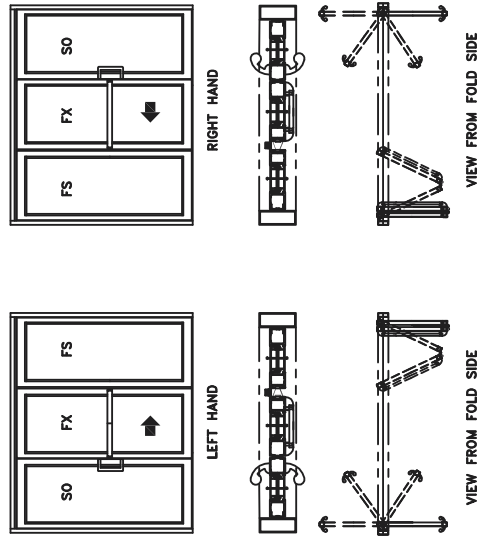

ICU FULL BREAKOUT THREE PANEL/TRACKLESS

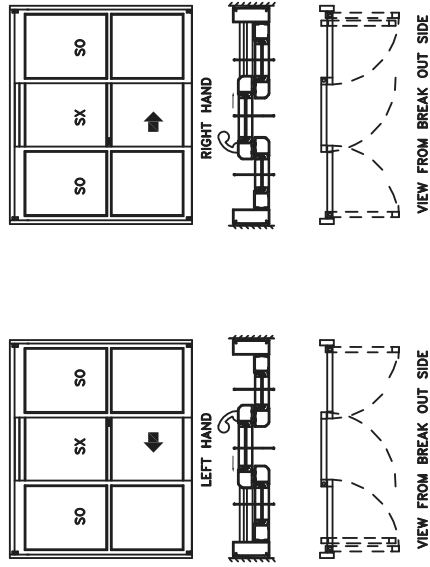

TELESCOPIC FSL SINGLE SLIDE

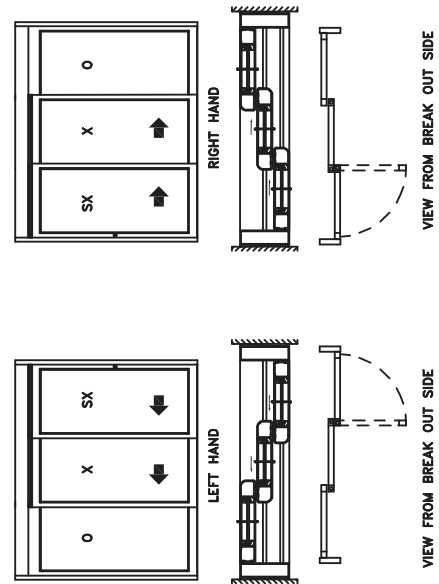

TELESCOPIC ICU NON PANIC SINGLE SLIDE

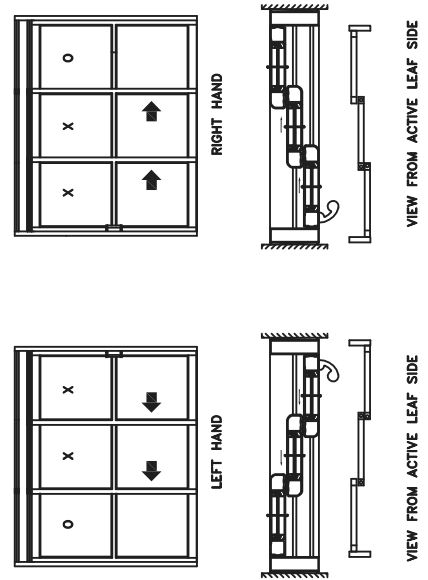

ICU FULL BREAKOUT TWO PANEL/TRACKLESS

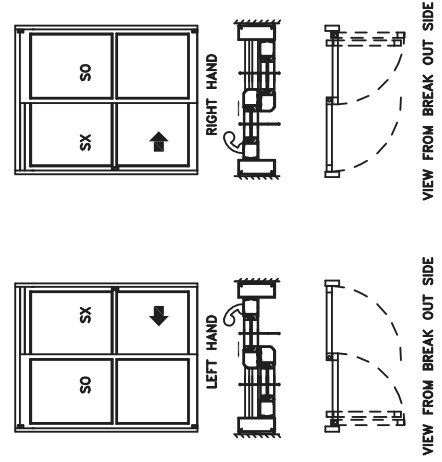



US15-2007-01 Swing Arm Kit, LH (shown)



US15-2007-02 Swing Arm Kit, RH



US15-2009-01 Fixed Guide Kit, LH (shown)



US15-2009-02 Fixed Guide Kit, RH



US15-2005-01 Pivot Guide Block Kit



US15-2010-03 Pivot Plate Kit, Standard, LH (shown)



US15-2010-04 Pivot Plate Kit, Standard, RH



US15-2010-01 Pivot Plate Kit, Telescopic, LH



US15-2010-02 Pivot Plate Kit, Telescopic, RH (shown)



US21-2008-00 Guide Track Cover. ** Cut to Length**



US15-2002-01 Breakout Cam Kit



US15-1656-01 Torsion Tube Kit



US15-2006-01 Transfer Bracket Kit



US09-0744-01 Screw, M4x8 (2 ea)



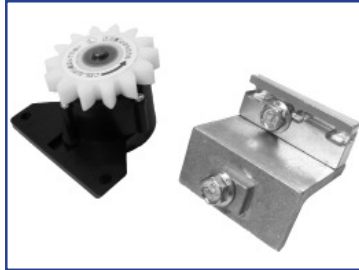

US15-1664-01 Speed Control Kit, 2-Panel



US15-1664-02 Speed Control Kit, Telescopic



US08-1664-E Pinion Gear Self Closure, Speed Control



US05-1665-01 Spring Assembly, 2-Panel, LH



US05-1665-02 Spring Assembly, 2-Panel, RH



US05-1665-03 Spring Assembly, Telescopic, 60", LH



US05-1665-04 Spring Assembly, Telescopic, 60", RH



US05-1665-05 Spring Assembly, Telescopic, 49", LH



US05-1665-06 Spring Assembly, Telescopic, 49", RH

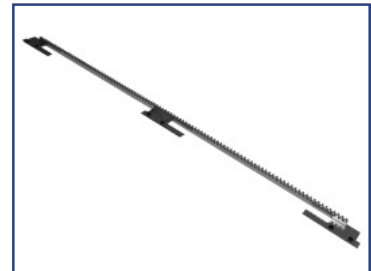

US05-1670-01 Gear Rack Assembly, 2-Panel



US05-1670-02 Gear Rack Assembly, Telescopic



US05-0545-00 Anti-static Assembly, PSA



US15-2004-07 Flush Bolt Kit, Single Throw, 10-1/4" Rod



US15-2004-06 Flush Bolt Kit (Positive Latch), Double Throw, 10-1/4", 66-9/16" Rods



Remember - search for all parts online at www.besam-usa.com

© ASSA ABLOY Entrance Systems US Inc.



US15-2004-08 Pin Guide
Flush Bolt Kit

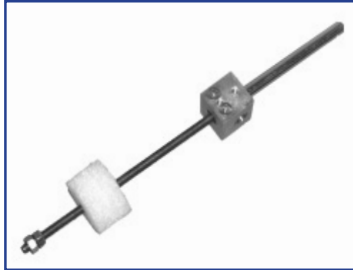

US15-2004-09 Extension Rod
Flush Bolt Kit



US24-2004-08 Flush Bolt
Warning Label



US08-1661-02 Pull, C-handle,
Optional Double



US15-1661-01 Pull, C-handle,
Standard Single



US15-1674-01 Flush Keeper
Kit



US08-1662-01 Conductive
Tape Copper Foil, Per Foot



US08-1653-01 Glass Block
Neoprene, 85 Duro
Sold Individually



US15-0392-01 Kit, ICU SA P-
Panel Stile Bracket



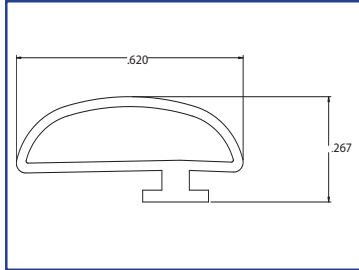

US20-1657-01 Smoke Seal, Door Stile

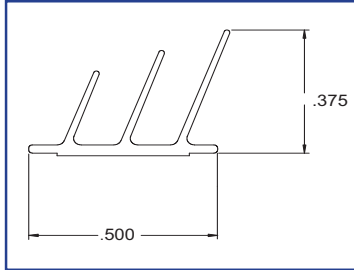

US20-1658-01 Smoke Seal, Header Track, Telescopic

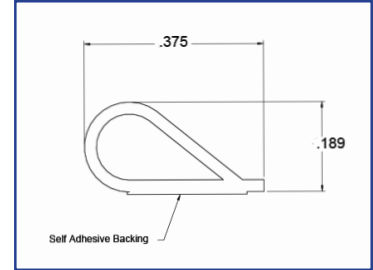

US08-0784-01 Smoke Seal, PK33

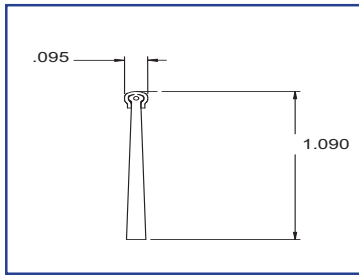

US20-1627-02 Smoke Seal Sweep, 48" Lengths



US01-0685-LLDB Brush Holder, Concealed Sweep

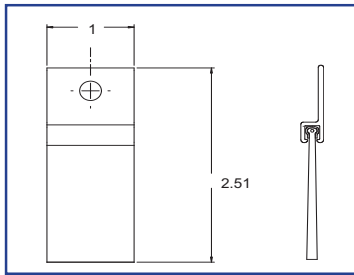

US15-1654-01 Brush Assembly, Anti-Static



US05-2100-01 Kit, Anti-Static Ground Stud



1011236 Glazing Tape



1011624-CL VersaMax TL SA,EndCap,CL (Shown)



1011624-DB VersaMax TL SA,EndCap,DB



1011639 VersaMax ICU Auto Endcap Kit





1011651 Endplate, Header,
Resilience



US15-1706-16 Access Control
PS Assembly



ICU TOUCHLESS

The global leader in door opening solutions



US02-1699-05 CU Control



US02-1699-07 Optex OA-Presence T Sensor



US02-1699-03 Wave Switch, Jamb Mount, Icon/WTO



US02-1699-04 Wave Switch, Wall Mount, Icon/WTO



US02-1699-06 Jamb Box, Surface Mounted



US04-1699-11 End Cap, TL SA, CL



US04-1699-12 End Cap, TL SA, DB (shown)



US15-1699-01 Auto Belt Bracket Kit

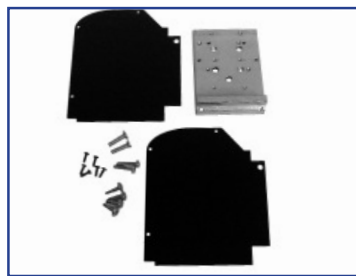

US15-1699-02 Auto End Cap Kit



US15-1706-01 Shutter Strike



ICU TOUCHLESS

The global leader in
door opening solutions

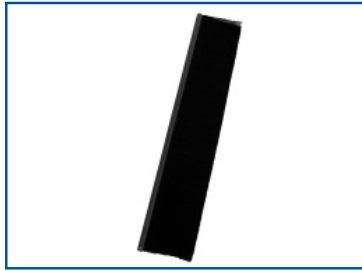

US20-1699-01 Auto Cover Brush,
96"



US20-1699-02 Auto Telescopic
Cover Brush



US24-1699-02 Automatic Caution
Decal



US24-1699-07 Decal, VersaMax
Touchless, Cover 3-Position



ICU SWING PACKAGE

The global leader in door opening solutions



US08-1641-01 Overhead Door Stop, Rixson

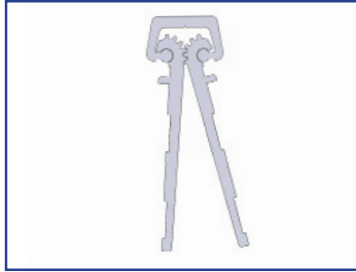

US08-1643-01 Pemko Continuous Hinge, 95", CL



US08-1643-02 Pemko Continuous Hinge, 95", BK



US08-1644-01 Dead Latch Paddle, AR4781, RH



US08-1644-02 Dead Latch Paddle, AR4781, LH

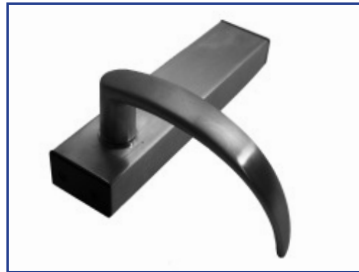

US08-1642-01 Entry Trim, AR3081

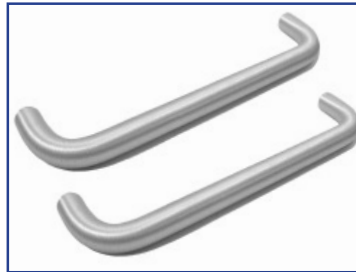

US08-1661-02 Pull, C-handle, Optional Double



US08-1683-01 C-Handle w/45 Degree Bend, Optional Double Pull



US1601 Door Closer, Norton 1601, CL



US1601BK Door Closer, Norton 1601, BK



US1601H Door Closer, Hold Open, Norton 1601H, CL



US1601HBK Door Closer, Hold Open, Norton 1601H, BK



US15-2004-07 Flush Bolt Kit, Single Throw, 10-1/4" Rod



ICU SWING PACKAGE

The global leader in door opening solutions

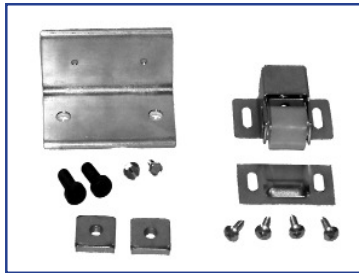

55-15-055 Mounting Kit, Nylatch, ICU (set of Two)

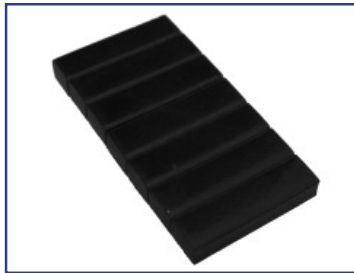

US08-1653-01 Glass Block Neoprene, 85 Duro Sold Individually

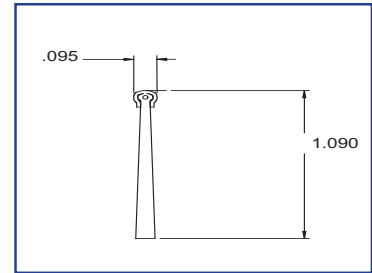

US20-1627-02 Smoke Seal Sweep, 48" Lengths



50-20-215 Sweep, Standard**



**Standard Unislide Concealed Brush, 1" Black

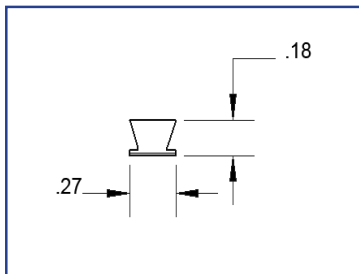

85-20-012 Felt Pile, Self Adhesive, 1/4" Back, BK

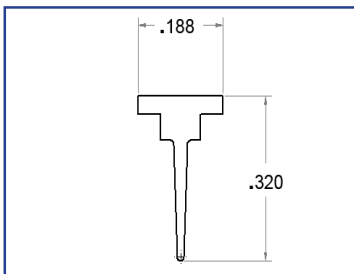

US20-1659-01 Silicone T-seal, Smoke Seal, ICU

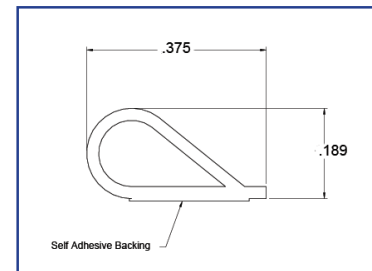

US01-0685-LLDB Brush Holder, Concealed Sweep



US08-0784-01 Smoke Seal, PK33, 17 Ft Roll, Black



STC = Sound Transmission Class = Smoke Seal

**ICU SWING PACKAGE
ANTI-MICROBIAL**

The global leader in
door opening solutions

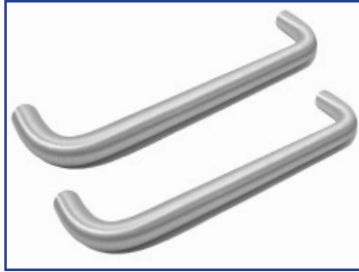

US08-1686-02 Pull, C-handle,
Optional Double,
w/Anti-Microbial Finish



US08-1687-01 C-Handle
w/45 Degree Bend, Optional
Double Pull, w/Anti-Microbial
Finish

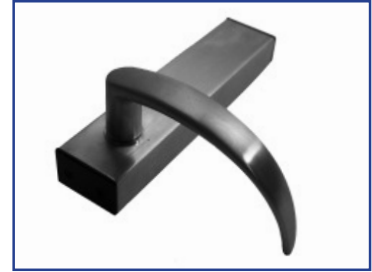

US08-1688-01 Entry Trim,
AR3081, w/Anti-Microbial
Finish



US08-1689-01 Dead Latch
Paddle, AR4781, RH,
w/Anti-Microbial Finish



US08-1689-02 Dead Latch
Paddle, AR4781, LH,
w/Anti-Microbial Finish



FOLD

The global leader in door opening solutions



50-05-072 Closer, End Load, Light Duty, OHC



55-03-025 Door Closer, Shaft Extension, OHC



55-15-075 Arm Closer Mounting Kit



55-15-008 Roller Block Assembly



55-04-046 Pivot Assembly, Top Door

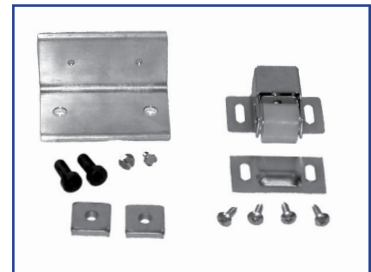

55-15-055 Mounting Kit, Nylatch



55-15-061 Pivot Stop Assembly



50-15-0005 Bottom Pivot Swing Kit



50-04-235 Mounting Clip, Slick Tube



FOLD

The global leader in door opening solutions



US15-2004-07 Flush Bolt Kit, Single Throw



US15-1661-01 C-Handle, Single Pull w/Hdwe, CL

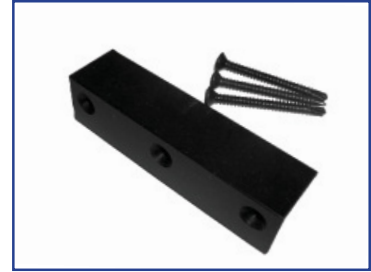

US15-1711-01 Door Stop Kit



50-15-022CL Hinge Kit, HD, S/MT, CL



50-15-022DB Hinge Kit, HD, S/MT, DB



60-20-100 Finger Guard, 7' w/Hardware, BK



60-20-102 Finger Guard, 8' w/Hardware, BK



US15-1720-01 Crash Bar Mtg Kit, CL & DB Hdwe included



50-01-152 Extr, Crash Bar, CL



50-01-153 Extr, Crash Bar, DB



US20-0227-01 Finger Guard, 8', RF, BK



US03-1723-01 Positive Latch Cam



US21-1725-01 Hinge Bearing



Remember - search for all parts online at www.besam-usa.com

© ASSA ABLOY Entrance Systems US Inc.

FOLD

The global leader in
door opening solutions

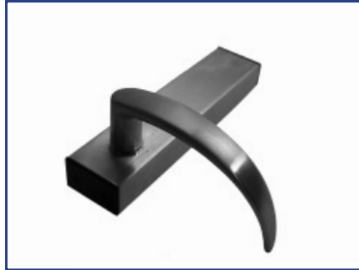

US08-1642-01 Entry Trim,
AR3081



US08-1644-01 Dead Latch
Paddle, AR4781, RH



US20-1659-01 Silicone T-seal,
Smoke Seal, ICU



55-15-120 Bearing Pivot As-
sembly, Carrier



55-15-121 Bearing Pivot As-
sembly, Double



55-15-122 Bearing Pivot As-
sembly, Single



55-15-123 Shaft Pivot Assem-
bly, LH (Shown)



55-15-124 Shaft Pivot Assem-
bly, RH



55-03-040 Shaft, Long, Top
Pivot

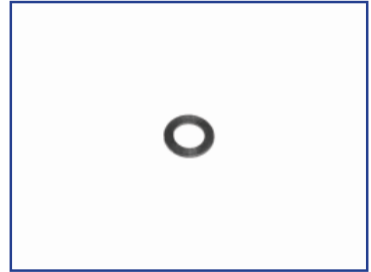

55-09-045 Washer, Thrust



FOLD

The global leader in
door opening solutions



55-04-075 Angle Mounting
Bracket Carrier



US15-0513-01 Wheel Roller Kit,
DHD



55-09-027 Pin, Retaining, 1/8"
X 1"

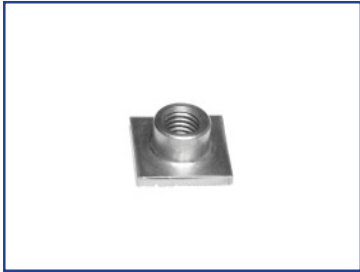

55-03-042 Insert, Roller, Carrier



55-21-023 Stop Block w/Screw



Remember - search for all parts online at www.besam-usa.com

© ASSA ABLOY Entrance Systems US Inc.

Smoke Seal Chart
(Sound Transmission Class)

The global leader in
door opening solutions

ICU/CCU Smoke Seal Chart	
Part Number	Description
US15-0786-01	Smoke Seal Kit Single Slide Clear
US20-0784-01	Pemko Smoke Seal PK33 17' Roll
US08-0784-02	Pemko Smoke Seal PK55 17' Roll
US08-0785-01	Pemko Brush Seal 18041CNB Clear 60" Long
US15-0787-01	Smoke Seal Kit Single Slide Dark Bronze
US20-0784-01	Pemko Smoke Seal PK33 17' Roll
US08-0784-02	Pemko Smoke Seal PK55 17' Roll
US08-0785-02	Pemko Brush Seal 18041CNB Dark Bronze 60" Long
US15-0787-01	Smoke Seal Kit Bi-Part Clear
US20-0784-01	Pemko Smoke Seal PK33 17' Roll
US08-0784-02	Pemko Smoke Seal PK55 17' Roll
US08-0785-01	Pemko Brush Seal 18041CNB Clear 60" Long
US15-0788-02	Smoke Seal Kit 3-Panel Clear
US20-0784-01	Pemko Smoke Seal PK33 17' Roll
US08-0784-02	Pemko Smoke Seal PK55 17' Roll
US08-0785-01	Pemko Brush Seal 18041CNB Clear 60" Long
US15-0788-03	Smoke Seal Kit 6-Panel Clear
US20-0784-01	Pemko Smoke Seal PK33 17' Roll
US08-0784-02	Pemko Smoke Seal PK55 17' Roll
US08-0785-01	Pemko Brush Seal 18041CNB Clear 60" Long
US15-0789-01	Smoke Seal Kit Bi-Part Dark Bronze
US20-0784-01	Pemko Smoke Seal PK33 17' Roll
US08-0784-02	Pemko Smoke Seal PK55 17' Roll
US08-0785-02	Pemko Brush Seal 18041CNB Dark Bronze 60" Long
US15-0789-02	Smoke Seal Kit 3-Panel Dark Bronze
US20-0784-01	Pemko Smoke Seal PK33 17' Roll
US08-0784-02	Pemko Smoke Seal PK55 17' Roll
US08-0785-02	Pemko Brush Seal 18041CNB Dark Bronze 60" Long
US15-0789-03	Smoke Seal Kit 6-Panel Dark Bronze
US20-0784-01	Pemko Smoke Seal PK33 17' Roll
US08-0784-02	Pemko Smoke Seal PK55 17' Roll
US08-0785-02	Pemko Brush Seal 18041CNB Dark Bronze 60" Long

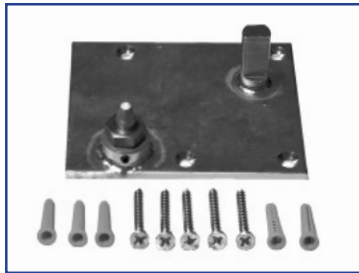

US15-0569-02 Pivot Base,
Trackless, RH



US15-0569-01 Pivot Base,
Trackless, LH (Shown)



US21-0277-01 Washer, Nylon,
Concealed Pivot

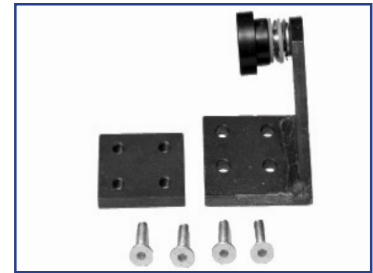

US05-0568-02 Door Foot,
Trackless, RH (shown)



US05-0568-01 Door Foot,
Trackless, LH



US21-0513-01 Wheel, Roller, DHD



US09-0957-01 Shoulder Bolt, DHD



US21-2011-01 Door Block,
Trackless, RH



US21-2011-02 Door Block,
Trackless, LH (Shown)



US15-2011-01 Mounting
Hardware Kit



50-15-146 Roller Guide Kit, (2 ea)



50-08-8805 Roller Guide, (1 ea)



50-09-146 Split Washer, (1 ea)





US05-0692-03 Foot Assembly,
Trackless, RH



US05-0692-04 Foot Assembly,
Trackless, LH (shown)



*** Used on prior trackless version,
with metal Door Block with square
side cut out***



50-15-137 Bottom Roller
Assembly, Active Leaf



US20-0485-01 Door Stop
Bumper



US05-0553-01 Dampener
Assembly, LH



US05-0553-02 Dampener
Assembly, RH



US15-0601-01 Cover Latch Arm

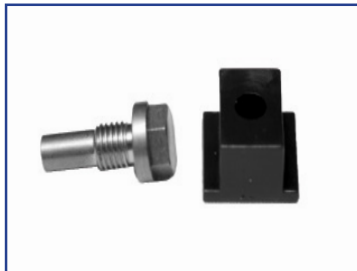

US15-0604-02 Anti-Riser Kit

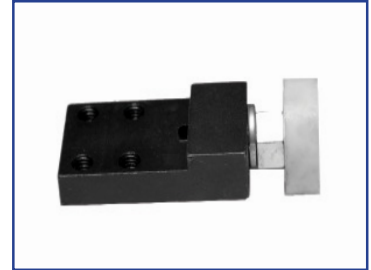

US15-0563-01 Roller Mounting
Bracket Assembly



US05-0600-01 Door Stop, LH



US05-0600-02 Door Stop, RH



US05-0552-01 FSL Connecting
Post



Remember - search for all parts online at www.besam-usa.com

© ASSA ABLOY Entrance Systems US Inc.



50-05-018 Pull Handle, 7", CL



50-05-047 Pull Handle, 7", BK



US21-0486-01 Flush Pull
(Plastic)



US15-0367-01 Positive
Latching Kit, CL (Shown)



US15-0367-02 Positive
Latching Kit, BK



US05-0367-01 Positive Latch
Set, AR4570, CL



US05-0367-02 Positive Latch
Set, AR4570, BK



US05-0367-04 Positive
Latching Deadbolt



US03-0367-02 Mounting Bracket



US08-0661-01 Lock Strike,
Positive Latch



US21-0327-01 End Cap, Door
Carrier



US03-0564-01 End Cap, RH



US03-0564-02 End Cap, LH
(shown)

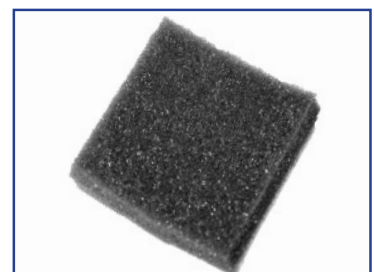

US20-0327-01 Cushion, End
Cap



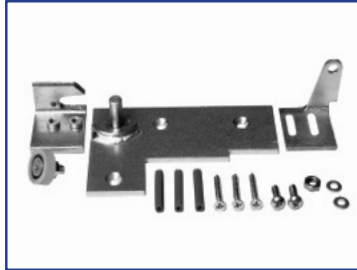

12-15-104 Pivot and Guide, A/L, RH, Kit (Shown)



12-15-105 Pivot and Guide, A/L, LH, Kit

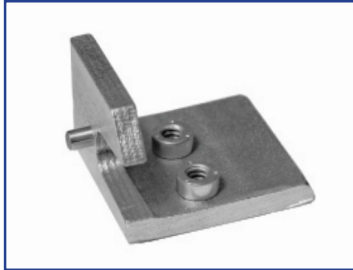

12-03-010 Trackless Breakout Bracket, RH



12-03-009 Trackless Breakout Bracket, LH



12-03-011 Roller Angle Brackets, LH



12-03-012 Roller Angle Brackets, RH



50-08-8805 Roller



50-09-146 Washer



12-15-115 Top Carriage Wheel Assembly, LH (Shown)



12-15-116 Top Carriage Wheel Assembly, RH



12-03-013 Eccentric for Roller



12-08-005 Roller Wheel, Steel



US05-1713-01 Cover Lock



(was 19-04-004)

Remember - search for all parts online at www.besam-usa.com

© ASSA ABLOY Entrance Systems US Inc.

ICU/CCU

ASSA ABLOY

The global leader in
door opening solutions



12-21-001 Plastic Extrusion Track



US21-0531-01 Dome Plug, 1/2",
Heyco

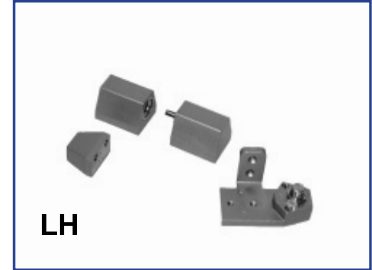

LH

50-15-560SCL Pivot, Kit, AMD FBO
RH, Clear



50-15-560SDB Pivot, Kit, AMD FBO
RH, Dark Bronze



50-15-561SCL Pivot, Kit, AMD FBO
LH, Clear (Shown)



50-15-561SDB Pivot, Kit, AMD FBO
LH, Dark Bronze



US15-0812-01 Medium Stile
Spacer Kit



US05-0600-08 Door Stop Kit,
Safety Stop, ICU, BiPart



Additional hardware (optional)

19-09-004 Washer,FLT,M6



50-09-106 Screw,SHC,1/4-20x1/2"
Black Zinc



US09-5405-01 Screw,SHC,1/4-
20x3/4",Zinc



TELESCOPIC

The global leader in door opening solutions

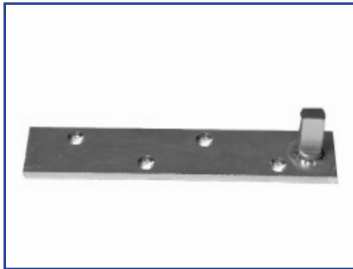

US05-0566-01 Pivot Base, Trackless

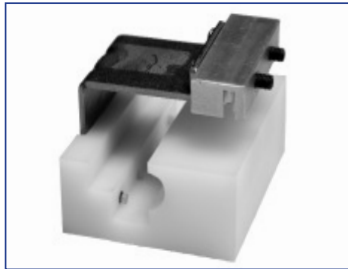

US15-0744-01 Slide Carriage Assembly



US05-0598-01 Tensioner Assembly



1000290 Wheel Stay Assembly



US05-0734-02 Slide Stop Assembly



US05-0614-01 Belt Anchor Assembly



US03-0734-11 Tensioner Bracket



735351 Tooth Belt, Large



1000062 Tooth Belt, Small

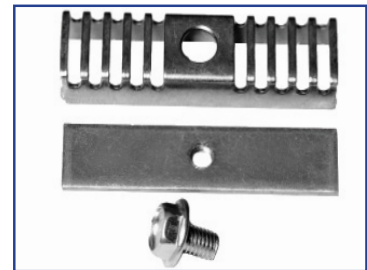

548786-1 Belt Clamp Kit



TELESCOPIC

The global leader in
door opening solutions



US04-0976-01 Tele-ICU Transom End Plate, CL (Shown)



US04-0976-02 Tele-ICU Transom End Plate, DB





50-05-072 Closer, End Load, Light Duty, OHC, 90 Degree HO



Once current inventory exhausted - use 1701868



55-03-025 Door Closer, Shaft Extension, OHC

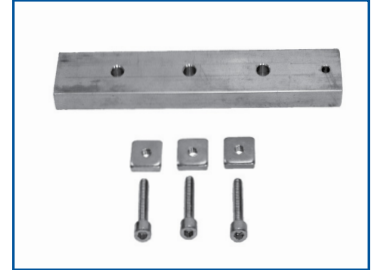

55-15-075 Arm Closer Mounting Kit



55-15-008 Roller Block Assembly



55-04-046 Pivot Assembly, Top Door



55-15-055 Mounting Kit, Nylatch



55-15-061 Pivot Stop Assembly



50-15-0005 Bottom Pivot Swing Kit

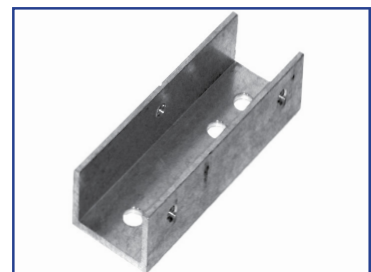

50-04-235 Mounting Clip, Slick Tube





50-04-137 Flush Bolt, CL



50-04-138 Flush Bolt, DB



50-05-018 Pull Handle, 7" CL



50-05-047 Pull Handle, 7" BK



US15-0144-01 Hinge Kit



50-15-022CL Hinge Kit, HD,
S/MT, CL



50-15-022DB Hinge Kit, HD,
S/MT, DB



60-20-100 Finger Guard, 7'
w/Hardware, BK



60-20-102 Finger Guard, 8'
w/Hardware, BK



50-20-150 Rubber Mount (1 ea)



50-09-050 Rivnut (1 ea)



50-09-103 Screw CL (1 ea)



50-09-115 Screw BZ (1 ea)



US20-0227-01 Finger Guard, 8',
RF, BK



Remember - search for all parts online at www.besam-usa.com

© ASSA ABLOY Entrance Systems US Inc.

TABLE OF CONTENTS

The global leader in
door opening solutions

<u>DESCRIPTION</u>	<u>PAGE</u>
UNITURN SERIES INTRODUCTION	I
CDC 4.1 CONTROL	1
UPGRADE KITS	2
MCU CONTROL	3 - 4
UNITURN SLIDER	5 - 7
DRIVES & BRAKES	8
WHEEL ASSEMBLIES	9
LOCKS & ACCESSORIES	10
SWITCHES & PUSH BUTTONS	11
DOOR ACTIVATION DEVICES	12
DOOR SAFETY DEVICES	13 - 17
BRUSHES	18 - 19
CEILING PANELS & ACCESSORIES	20 - 22
HARDWARE / SIGNAGE	23 - 25
GLASS	26 - 27
FASCIA SHEETS	28
RD SERIES INTRODUCTION	II
MAIN	1 - 4
BRUSHES	5
GLASS STOP	6
SAFETY EDGES	7 - 8
RD / RDA GLASS	9 - 10
CEILING PANELS	11
RDA SERIES	1 - 11
SECURE360	8 - 10
BRUSHES	11
RD4-100 MANUAL SERIES	1 - 2

Remember - search for all parts online at www.besam-usa.com

© ASSA ABLOY Entrance Systems US Inc.

Rev E

UNITURN SERIES INTRO

The global leader in door opening solutions

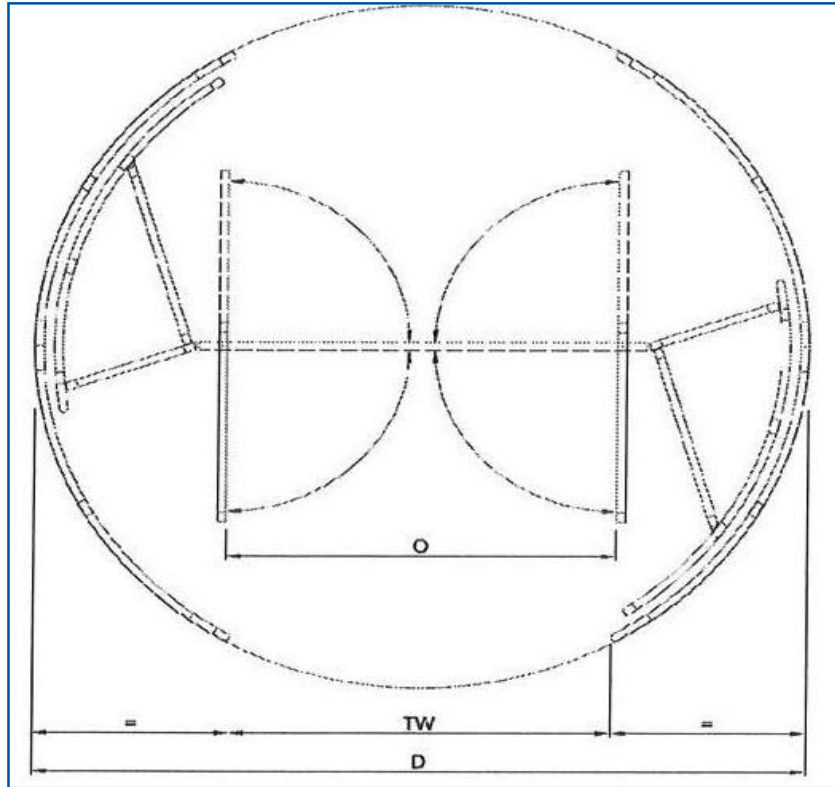

Uniturn, RDB2

The Uniturn door is a “two wing” revolving door with no center shaft. It is a perimeter drive door, completely supporting the drive frame, display cases and door leafs from its upper drive ring located above the rotating ceiling.

Diameters:

Uniturn 36 = 12 foot diameter revolving door.

Uniturn 42 = 14 foot diameter revolving door.

Uniturn 48 = 16 foot diameter revolving door.

Uniturn 54 = 18 foot diameter revolving door.

CDC 4.1 CONTROL

The global leader in door opening solutions

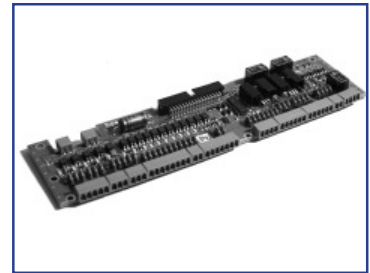
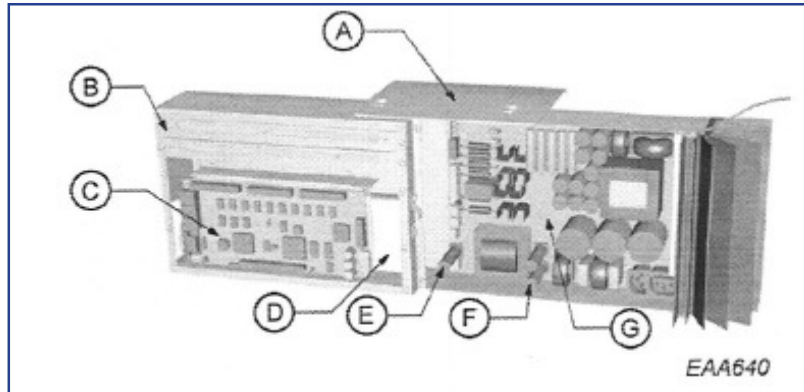

260040 Board, IOA (B)



264898 Control, CDC, 4.1 (A)



714003 Fuse 16 AT (E)



713983 Fuse 10 AT (F)



33265550 Cable Kit, Fixed Part



33265501 Cable Kit, Rotating Part



265712 Battery, Version 4.0/4.1 (D)

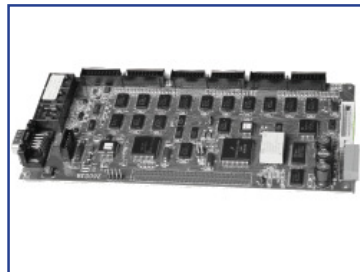

260038 MPU Board, CDC with CFD, Version 4.0

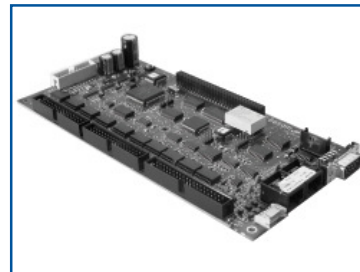

1000182 MPU Board, CDC Version 4.1 (C)



655565 Power Supply, Main, CDC (G)



33265764 Fan, CDC, 4.1

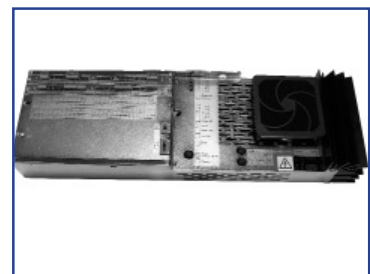

265730 Control, CDC 4.1 SD w/ Fan



Remember - search for all parts online at www.besam-usa.com

© ASSA ABLOY Entrance Systems US Inc.

UPGRADE KITS

The global leader in
door opening solutions

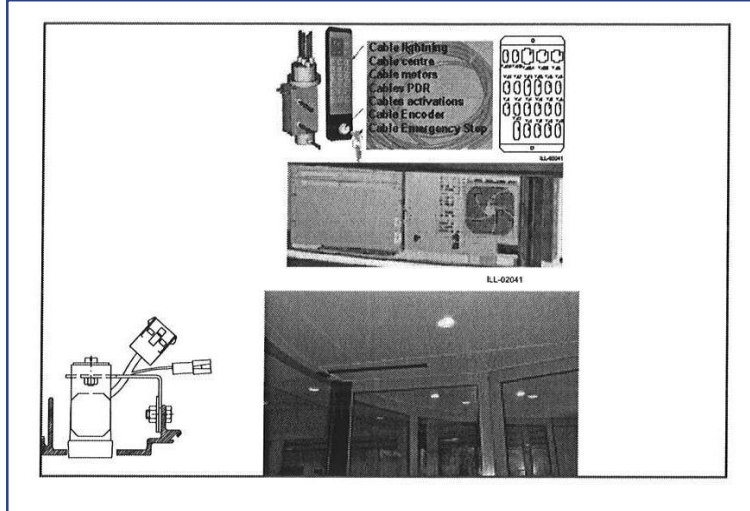

1005117 Upgrade Kit from
MCU system to CDC 4.1



Includes:

- Control Unit
- PCD program control device
- Slip Ring
- Center connection Plate
- Cable Kit

Note:

MCU IE, mechanical lock
needs to be changed to lock for
CDC P/N 260656

264898 Upgrade from CDC
3.0 to CDC 4.1



Includes:

- Control, CDC 4.1 (265730)
- Center Connecting Plate
- PCD Extension Kit
- Power Cable
- Lighting Cable
- Motor Plug (2)
- E-Stop Plug
- 1K Resistor



MCU CONTROL

The global leader in door opening solutions

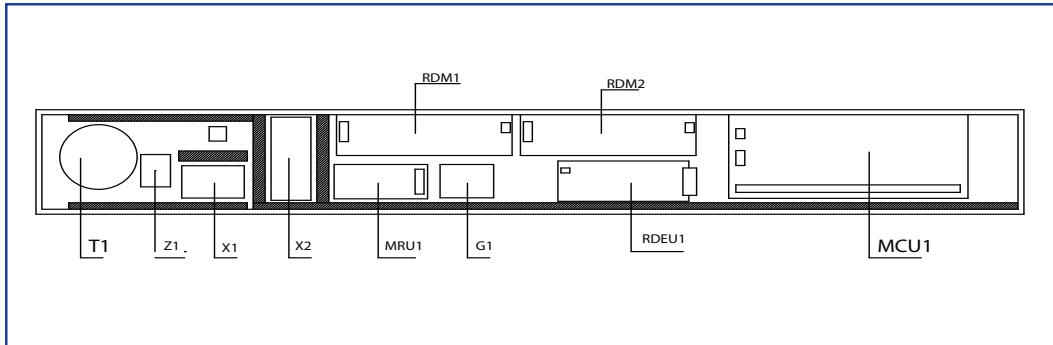

MCU Control (Illustration)

* Denotes location on Illustration



714369 Filter, RDB *(Z1)



OBS

654062 Control, Motor Relay PCB, RDB *(MRU1) - **Obsolete**



653983 Control, Motor PC Board, RDB *(RDM1 and RDM2)



654184 Battery Back-up, RDB *(G1)

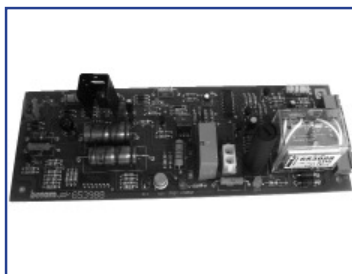

653988 Control, KDEU Rev Battery Unit *(RDEU1)

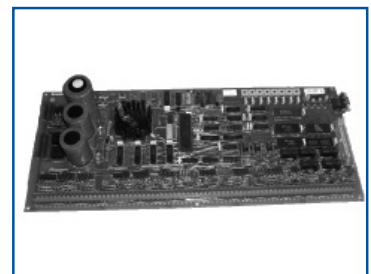

653677 Control, Main PCB, KDAC *(MCU1)



Remember - search for all parts online at www.besam-usa.com

© ASSA ABLOY Entrance Systems US Inc.

MCU CONTROL

The global leader in door opening solutions

33707577 Earth Connector (**A**)



705104 Relay (**B**)



705114 Relay (**C**)



33714141 Fuse Holder 48V (**D**)



33714140 Fuse Holder 24V (**E**)



713983 Fuse F12, 10.0 Amp (slow) (**F**)



713936 Fuse F13, F14, 1.0 Amp (slow) (**G**)



713561 Fuse F15, 5.0 Amp (slow) (**H**)



*(X2)

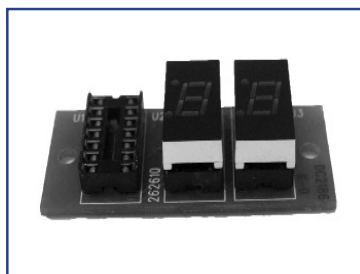
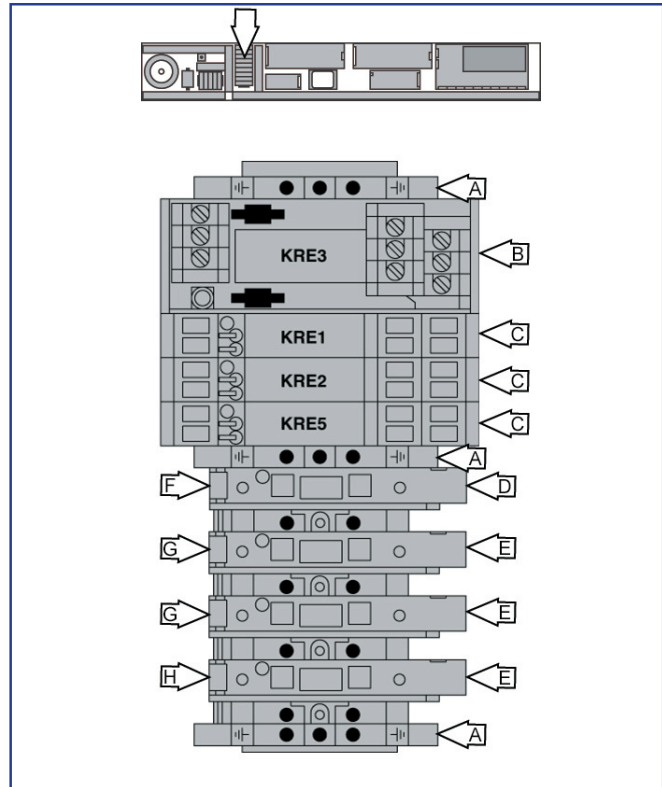

262610 Board, Display, LED



246273 Display Cable, Digital, for RDB



245482 Encoder, Position, RDB



W / SLIDER

The global leader in door opening solutions

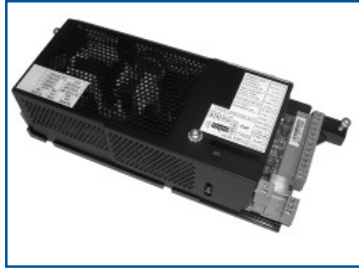

331004262H Control Unit Uniturn w/Slider w/ EXA4 (was 331004124)



1006705 EXA-4 Extension Unit



550570 Motor Unit Uniturn w/slider - Heavy Duty



1006253 Motor Unit Uniturn w/slider - Standard Duty



331002142 Program Selector, UT, w/Slide



331002155 Connection Block Uniturn w/Slider (B)



331003714 Connection Block door leaf Uniturn w/slider (C)

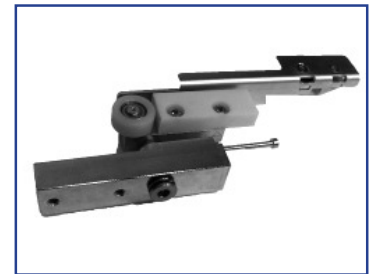

331002121 Door Carriage Top Mid Uniturn w/Slider (D)



331002102 Door Carriage Top Back Uniturn w/Slider (E)



331002123 Door Carriage Bottom Back Uniturn w/Slider (F)



331003710 Catcher Center



Remember - search for all parts online at www.besam-usa.com

© ASSA ABLOY Entrance Systems US Inc.

W / SLIDER

The global leader in
door opening solutions



331003466 Catcher Bottom
Rack

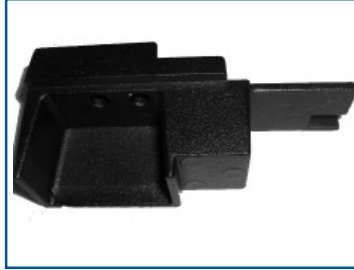

331003762 Lock, Sliding
Door Housing

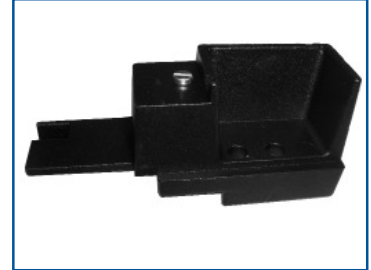

331003763 Striking Plate,
Lock



331002111 Stop Lug

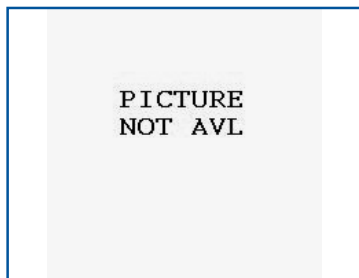

331002131-XX Drive Belt - (A)
(XX = Door Size,36,42,48,54)

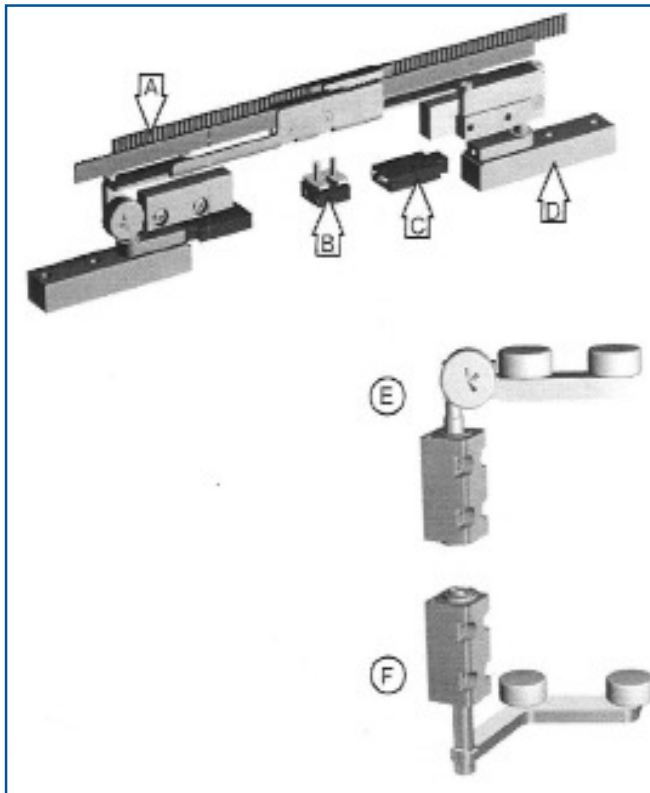

Door Carrier Centre - Items B thru F are detailed
on previous page 5.

W / SLIDER

The global leader in door opening solutions

716307 Brush Sealing (A)
(ORDER PER FOOT)



***1003769** Rubber-profile (B)



* Field Prep.

****1002132-36** Safety Switch (C)



****1002132-42** Safety Switch (C)



****1002132-48** Safety Switch (C)



****1002132-54** Safety Switch (C)



**

36 = 12 Ft. Diameter Door

42 = 14 Ft. Diameter Door

48 = 16 Ft. Diameter Door

54 = 18 Ft. Diameter Door

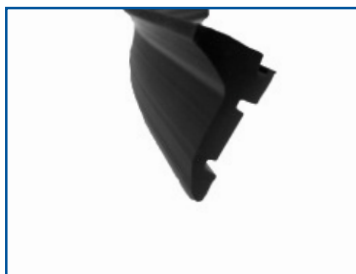
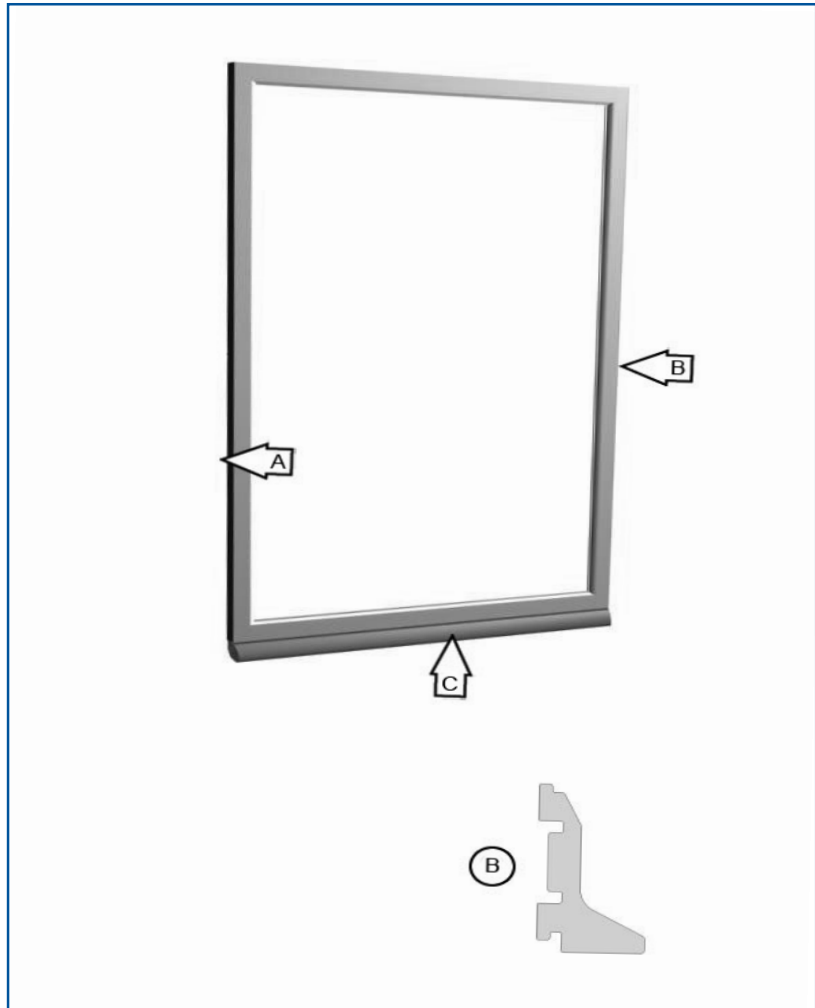

Rubber-profile (B)



Safety Switch (C)



Brush Sealing (A)

Remember - search for all parts online at www.besam-usa.com

© ASSA ABLOY Entrance Systems US Inc.

DRIVES & BREAKS

The global leader in door opening solutions

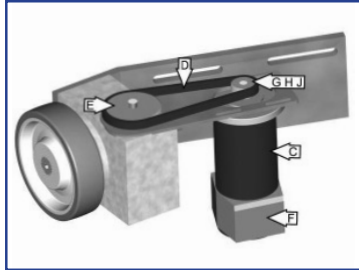

265022 Drive Unit Complete (A)
(NOTE BRACKET LOCATION)

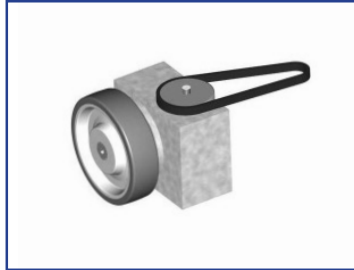

265821 Gearbox, w/Wheel, Pulley & Belt



245988 Motor Unit , Lenze



331700217 Motor Unit Filter, Lenze, CDC Ver. 4.1 (C)



723215 Mounting Bolt



735271 V-belt, 457 (D)



245745 Pulley Wheel, 2 11/16" (E)



248427 Carbon Brush (2 pcs.) (F)



245743 Pulley Wheel, Motor 1 1/16" - 27MM (G)



735130 Key, Pulley (H)



723180 Set Screws (J)

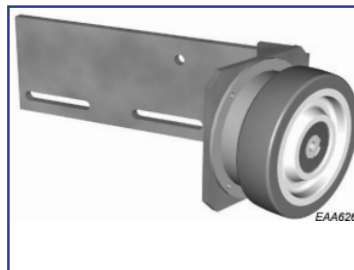

265021 Brake Unit, Uniturn Only

Note Bracket Hole Location



244723 Break Unit (RDB Only)

(NOTE BRACKET LOCATION)



WHEEL ASSEMBLIES

The global leader in
door opening solutions



258527 Gearbox, RDB
Complete
(NOTE BRACKET LOCATION)



244726 Wheel, Drive Unit,
RDB



265183 Brake Wheel, RDB

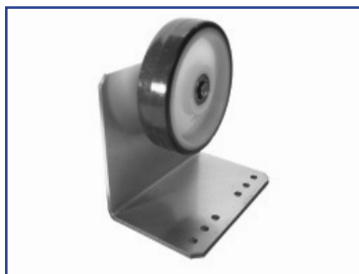

265265 Wheel, Support



735130 Keyway for Pulley



Remember - search for all parts online at www.besam-usa.com

© ASSA ABLOY Entrance Systems US Inc.

LOCKS & ACCESSORIES

The global leader in door opening solutions

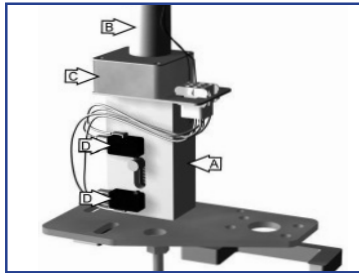

265154 Lock, Electro-mechanical, CDC



263409 Motor Gear (B)



33263408 Electro-mechanical Lock Gearbox (C)



USV3101D8 Micro Switch, No Arm (D)

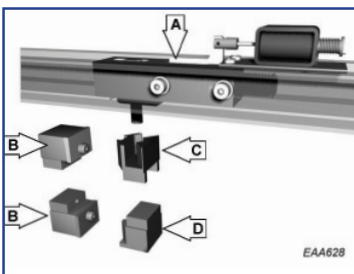

Escape Door Lock



265216 Lock, Storm (A)



244872 Interlocking, Male, Upper/Lower, (B)



246655 Interlocking Block Upper (C)



244869 Interlocking, Female, Lower (D)



**SWITCHES & PUSH
BUTTONS**

The global leader in
door opening solutions



262136 Switch, PCD (A)



264612 Key, Spare PCD (C)



655245 Cable, PCD (D)



260051 Interface Box, PCD (E)



709554 Key Switch, PCD (B)



264065 Spacer Frame only for
262136

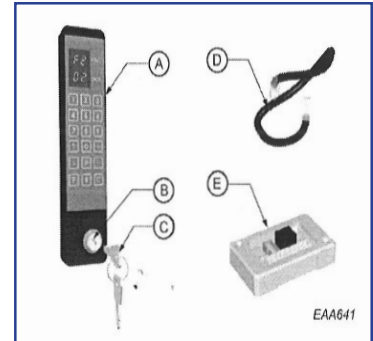

EAA641



261969 Push Button Plate



240744 Switch, Key, 6 Position,
RDB (5 + GND)



707468 Key only



USBOXJAMBSM Box Push
Plate, Jamb, Swingmaster



248518 Sensor, Beam, Hold-
ing - PDR Photocell, Entry Point

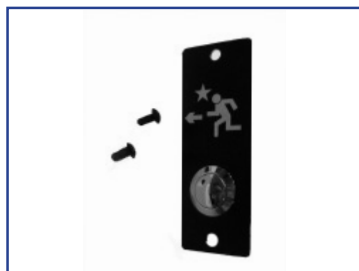

261970 Push Button, Escape
w/Plate



331002217 Push Button,
Escape, Flush Mount



USPBJSREV Push Plate, Jamb,
Push To Slow, H/C



Remember - search for all parts online at www.besam-usa.com

© ASSA ABLOY Entrance Systems US Inc.



264300 DSR Unit Activator (A)



264299 DSR Unit incl. Bracket



33264305 Glass Cover (B)

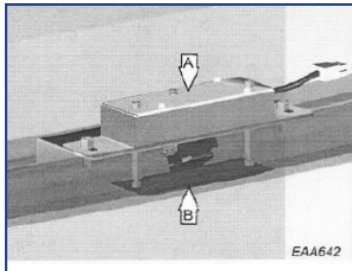

262159 Motion Sensor, PIR



**DOOR SAFETY
DEVICES**

The global leader in
door opening solutions

CFD (Capacitive Field Detector) Supplies are Limited

The following CFD (Capacitive Field Detector) parts will no longer be available when supply is exhausted.

5.10 CFD Sensors					
	UniTurn-36	UniTurn-42	UniTurn-48	UniTurn-54	Length
A*	263168	263168	263168	263168	83 1/4"
B	245197				20 1/4"
B		247394			25 9/16"
B			245196		32 1/2"
B				265653	38"
C	241131	241131	241131	241131	End Cap
D	263170	263170	263170	263170	CFD Cover state Length
	724123	724123	724123	724123	End cap screws, standard lengths

263168	Obsolete
245197	Obsolete
247394	Obsolete
245196	Obsolete
265653	Obsolete
241131	
263170	Obsolete
724123	Obsolete

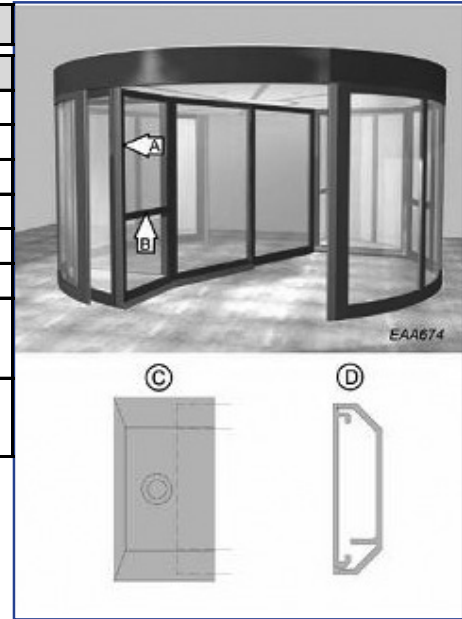

36 = 12 Ft. Diameter Door
42 = 14 Ft. Diameter Door
48 = 16 Ft. Diameter Door
54 = 18 Ft. Diameter Door

5.11 CFD Control Box		
Pos.	Part No.	Description
A+B	33243680 -NLA	Control Box Incl. Main PC-Board
B	245205 -NLA	Main PC-Board
C	243682	Vertical/Horizontal PC-Board
	33243680	Obsolete
	245205	Obsolete
	243682	Obsolete

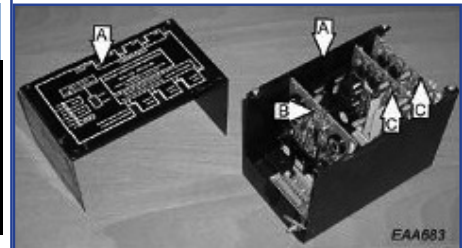

NLA - No longer available

Remember - search for all parts online at www.besam-usa.com

© ASSA ABLOY Entrance Systems US Inc.

DOOR SAFETY DEVICES

The global leader in door opening solutions

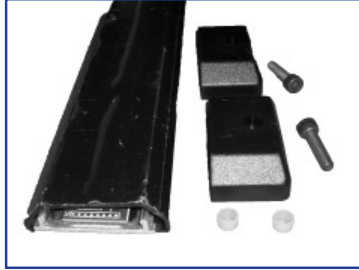

245864 CFD, L=1210, CLA, CLB, RDB



* Part Supplies Limited



247044 Switch, Pivot Door RDB



261435 Cable, 5M (16.5 Ft.), CFD, Memco

Obsolete

CFD Replacement - Older MCU type revolving doors, use SuperScan II

Description	Besam Part Number
Sensor, BEA Superscan II, 32"	US02-0274-03
Sensor, BEA Superscan II, 34.5"	US02-0274-14
Sensor, BEA Superscan II, 40"	US02-0274-08
Sensor, BEA Superscan II, 42"	US02-0274-15
Sensor, BEA Superscan II, 46"	US02-0274-16
Sensor, BEA Superscan II, 48"	US02-0274-17







DOOR SAFETY DEVICES

The global leader in door opening solutions



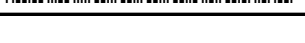

For CFD Replacement - CDC controls, use 4Safe sensors

4SAFE Upgrade Kit

Including cabling & ceiling panels. Sensors preset from factory

Description	Part No.
4SAFE Kit - 36	330000194
	
4SAFE Kit - 42	330000195
	
4SAFE Kit - 48	330000196
	
4SAFE Kit - 54	330000197
	
CW 4SAFE Kit - 36	330000198
	
CW 4SAFE Kit - 42	330000199
	
CW 4SAFE Kit - 48	330000200
	
CW 4SAFE Kit - 54	330000201
	

Spare Parts 4SAFE

Pos.	Description	Part No.
A	Sensor / Head Only	330000187
		
B	Hub	1700958
		
C	Interface Cable	1005804
		
D	Cover	1004182
		

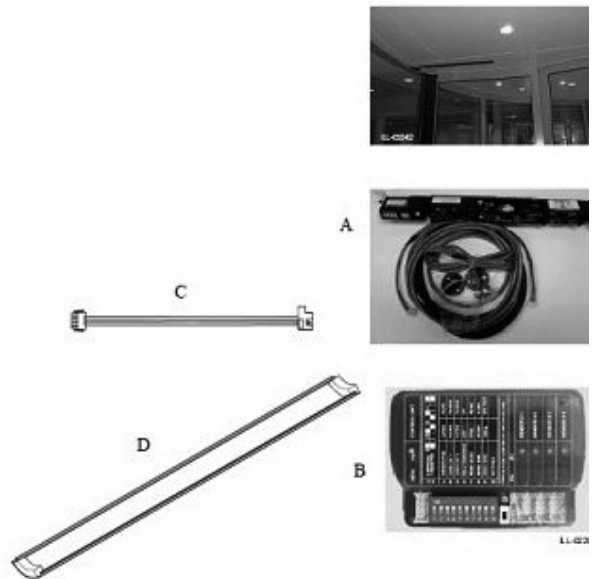

36 = 12 Ft. Diameter Door
 42 = 14 Ft. Diameter Door
 48 = 16 Ft. Diameter Door
 54 = 18 Ft. Diameter Door

Remember - search for all parts online at www.besam-usa.com

© ASSA ABLOY Entrance Systems US Inc.



261436 Cable, CFD Sensor
OBS



331002439 Switch, Emergency
Stop, REV, New



331700069 Cover, Emergency
Stop



262529 Emergency Stop
Button, Standard, RDB



247532 Sensor, MR3, Kit
(PDR for Rotating Ceiling)



247567 Bezel, Mounting,
MR-3 (for 247532)



714135 Sensor Only, MR3
(for 247532)



714107 Inductive Sensor



1700773 Kit, 4SAFE Sensor
SP51M (L=350mm)



DOOR SAFETY DEVICES

The global leader in door opening solutions

244961 Passive Safety Edge (A)
86 5/8"



265162-36 Horizontal Tripswitch Escape (D)
Door 42 1/4"



265162-42 Horizontal Tripswitch Escape (D)
Door 48 1/8"



265162-48 Horizontal Tripswitch Escape (D)
Door 54 1/16"



265162-54 Horizontal Tripswitch Escape (D)
Door 60" Special Order-Not Stocked



265163-36 Horizontal Tripswitch Sensor (C)
Door 25 3/16"



265163-42 Horizontal Tripswitch Sensor (C)
Door 31 5/16"



265163-48 Horizontal Tripswitch Sensor (C)
Door 37 3/8"



265163-54 Horizontal Tripswitch Sensor (C)
Door 43 1/2" Special Order-Not Stocked



265599 Vertical Safety switches (B)
85 1/2"



265599SPDX Vertical Safety (B)
switches, special order lengths*



* **Information Required to place order:**
Internal floor to ceiling height in millimeters.
Special Order - extended delivery time.

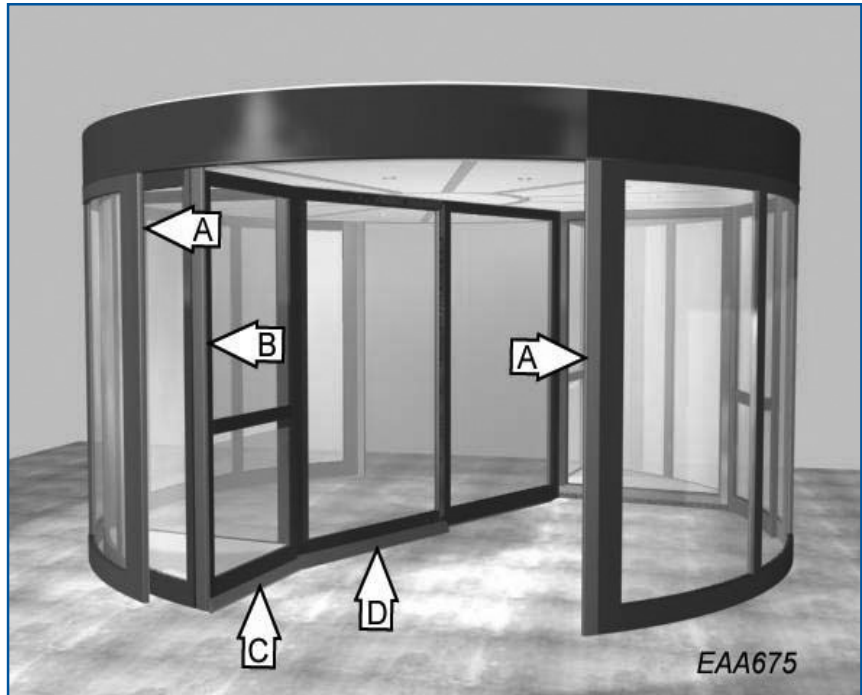

244960 Active Safety Edge (A)
86 5/8"



Remember - search for all parts online at www.besam-usa.com

© ASSA ABLOY Entrance Systems US Inc.

BRUSHES

The global leader in door opening solutions

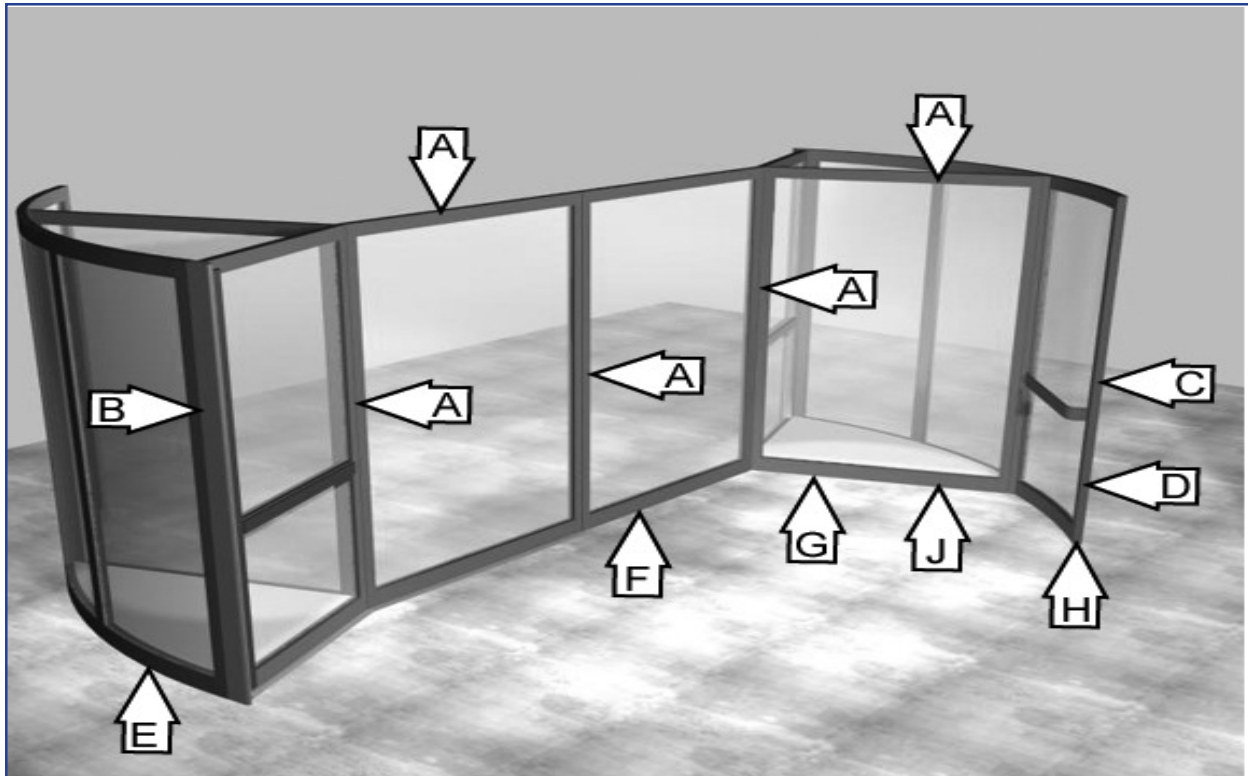

EAA657

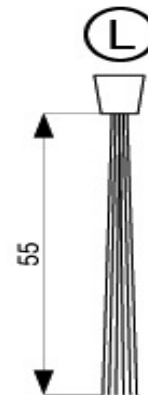
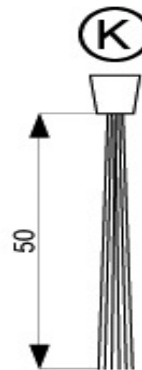
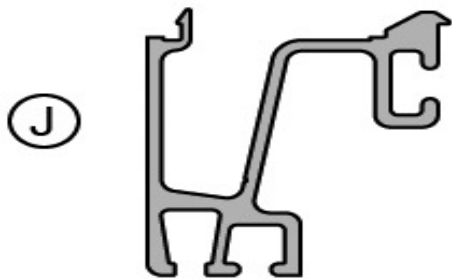
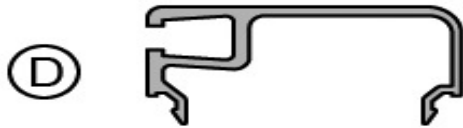

Uni-Turn brushes chart and barcodes are listed on the next page.

BRUSHES

The global leader in
door opening solutions

	UniTurn-36 (12')	UniTurn-42 (14')	UniTurn-48 (16')	UniTurn-54 (18')	Length	Thickness
A	33716277	33716277	33716277	33716277	To be stated	.314"
B	244907	244907	244907	244907	85.51"	2.165"
C	244908	244908	244908	244908	81.26"	2.165"
D	244632	244632	244632	244632	Brush holder pos. C	
E	244904				74.41"	1.653"
E		247304			86.81"	1.653"
E			244900		99.21"	1.653"
E				265075	111.61"	1.653"
F	244905				42.24"	1.77"
F		247305 -USE 244901			48.15"	1.77"
F			244901		54.06"	1.77"
F				265076	59.96"	1.77"
G	244906				38.90"	1.77"
G		247306 -USE 244902			46.02"	1.77"
G			244902		52.95"	1.77"
G				265077		1.77"
H	245846	245846	245846	245846	Corner	Corner
J	265165-36	265165-42	265165-48	265165-54	Brush holder pos. G	
K ^a	246230	246230	246230	246230	To be stated	1.968"
L ^a	246229	246229	246229	246229	To be stated	2.165"
M	33246087	33246087	33246087	33246087	Corner	Corner

a = Brushes pos. F and G with extended height
Item B, C and D state the internal height

244632		247304	
244900		247305	USE 244901
244901		247306	USE 244902
244902		265075	
244904		265076	
244905		265077	
244906		33246087	
244907		33716277	
244908		265165-36	
245846		265165-42	
246229		265165-48	
246230		265165-54	

Remember - search for all parts online at www.besam-usa.com

© ASSA ABLOY Entrance Systems US Inc.

8.2 Ceiling Panels UniTurn 12'/14' Diameter







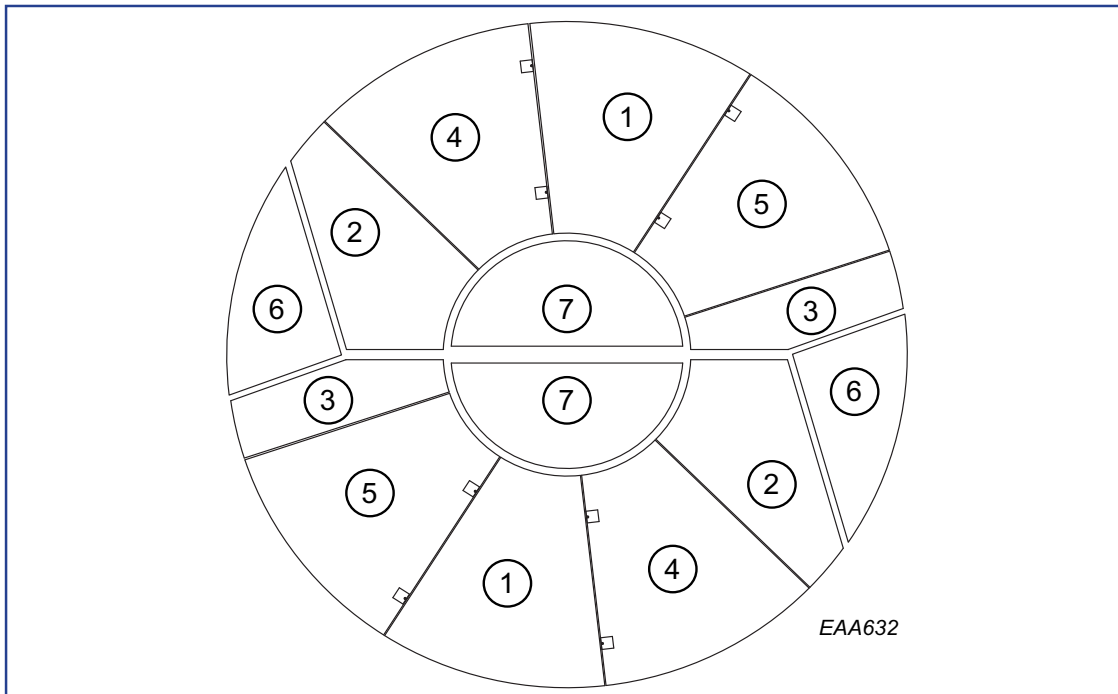









	UniTurn-36 (12')		UniTurn-42 (14')	
1	245579		247479	
2	245580		247480	
3	245581		247481	
4	245582		247482	
5	245595		247495	
6	244796		247496	
7	244645		244645	
Floor in display area	265053-36		265053-42	

Note!

Always state if the ceiling panels shall be prepared for lighting. If the surface is other than standard (white laminate) then state the surface.



8.3 Ceiling Panels UniTurn 16'/18' Diameter

	UniTurn-48 (16')		UniTurn-54 (18')	
1	245787		265043	
2	245585		265041	
3	245586		265046	
4	245584		265044	
5	245786		265042	
6	245587		265045	
7	244696		265050	
8	244645		244645	
Floor in display area	265053-48		265053-54	

Note!

Always state if the ceiling panels shall be prepared for lighting. If the surface is other than standard (white laminate) then state the surface.

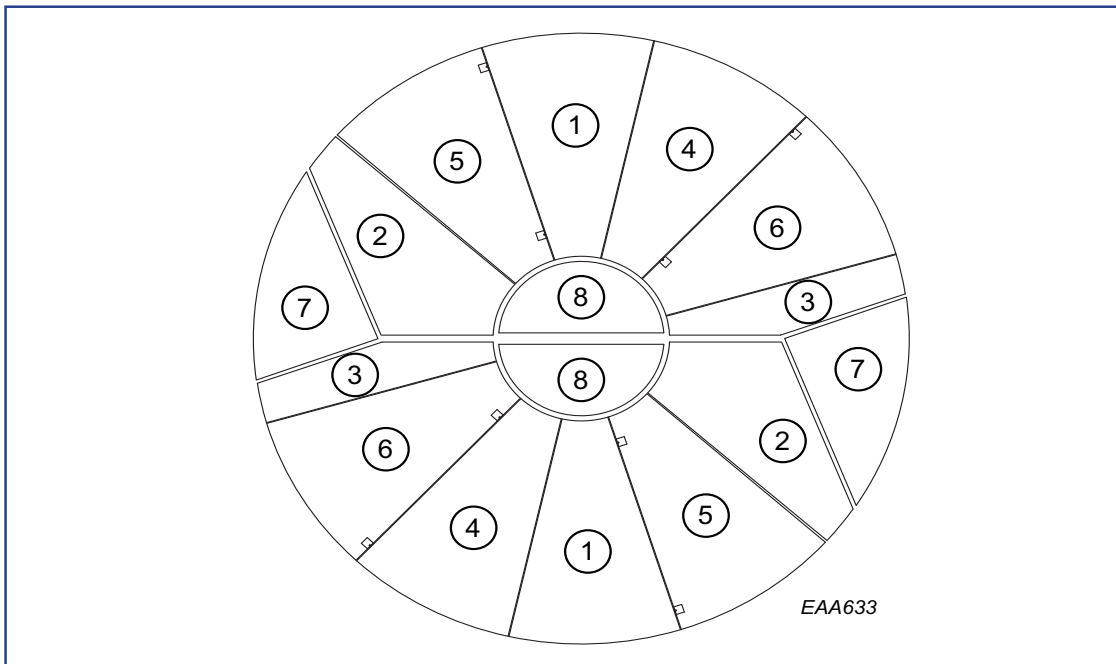

Remember - search for all parts online at www.besam-usa.com

© ASSA ABLOY Entrance Systems US Inc.

CEILING PANELS & ACCESSORIES

The global leader in
door opening solutions



715442 Transformer, for Lights

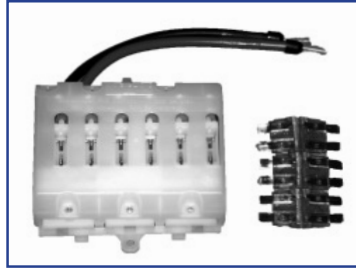

715443 Fuse, Bank
Transformer, RDB



707608 Spotlight, Housing,
Halogen - *Replaced by 331010688*

331010688 Spotlight, Housing, LED



707665 Bulb, Spotlight, 35W



Obsolete when supply exhausted



655245 Cable, PCD - RDB



1702145 Lamp, LED 5W 12V
for 331010688 above

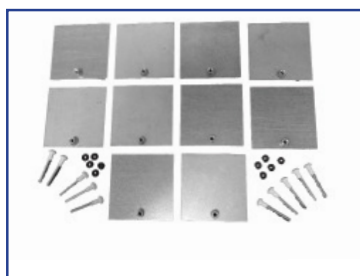

330000012 Kit, Locking
Bracket , Ceiling Panel - 10 sets
per kit



260051 Interface Box, PCD - RDB

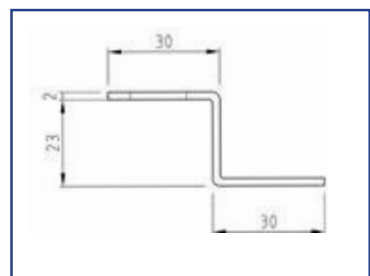

245834 Z Bracket, Ceiling



724224 Screw for above



HARDWARE / SIGNAGE

The global leader in
door opening solutions



1011681 Slip Ring (was 264087)



723010 Mounting Screw only



245829 Hub, RDB



244975 Cone, Guiding



244874 Interlocking, Male,
Lower

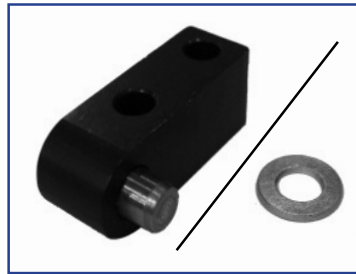

244898 Hinge Pivot (less washer)
for Display Case Door



729017 Washer, Hinge Pivot-
Display Case Door



Hinge Pivot for Display Case Door



265022-1 Motor/Gearbox
Heater



244865 Hinge, Bottom, RDB



244866 Hinge, Top, RDB



Remember - search for all parts online at www.besam-usa.com

© ASSA ABLOY Entrance Systems US Inc.

HARDWARE / SIGNAGE

The global leader in door opening solutions



729166 Snap Ring, RDB



244880 Lock, Display Cabinet, RDB

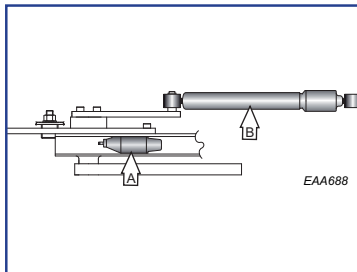

Escape Door



709590 Limit switch, Uniturn Escape Door (A) - OBS Use 331702605

331702605 Limit Switch Kit



244923 Damper Escape Door (B)



331006099 Reinforcement Kit, Drive Frame

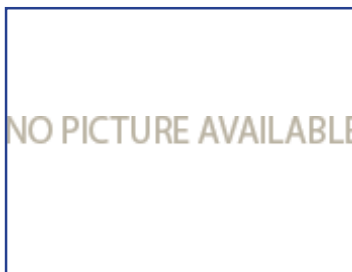

33262544 Cover, Water Resistant



1007233 Compression Lock, Display



HARDWARE / SIGNAGE

The global leader in door opening solutions



1001695 Decal, Supervision



1001785 Decal, Escape Right



1001786 Decal, Escape Left



USREVTOOL1 Ball Screwdriver Set, Metric



USREVTOOL2 Pin Puller Tool, AMP



USREVTOOL Allen Wrench Set, Metric



50-24-022 DECAL,Safety Info, Revolvers



50-24-023 DECAL,Emergency Stop,Revolver



Remember - search for all parts online at www.besam-usa.com

© ASSA ABLOY Entrance Systems US Inc.

GLASS

The global leader in door opening solutions



716268 Rubber Glazing strips, Standard



33258414 Rubber Glazing strips, Stainless Steel Cladded Door



Outer walls without midrail

UniTurn-36	UniTurn-42	UniTurn-48	UniTurn-54	Note
3326505836	3326505842	3326505848	3326505854	4+4mm lam. glass
3326518536	3326518542	3326518548	3326518554	Infill panel

Note! If not Standard state IH

36 = 12 Ft. Diameter Door
 42 = 14 Ft. Diameter Door
 48 = 16 Ft. Diameter Door
 54 = 18 Ft. Diameter Door

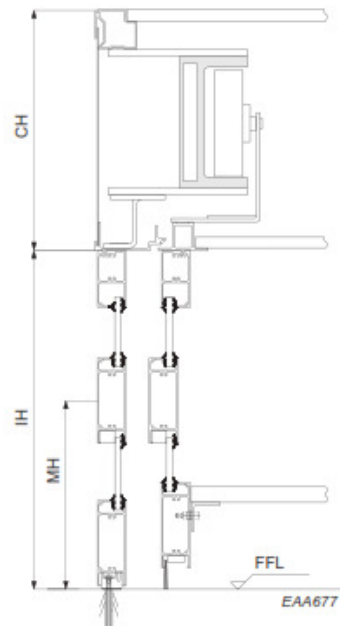

GLASS

The global leader in door opening solutions

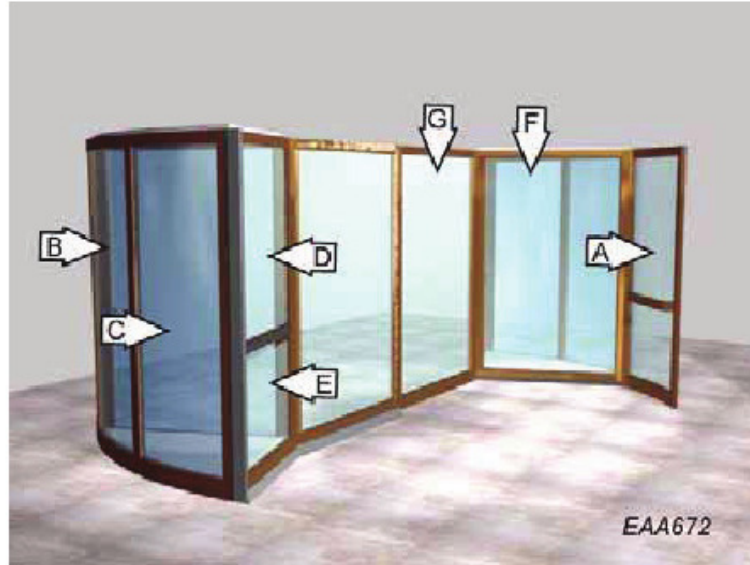

Rotating part without midrails

	UniTurn-36	UniTurn-42	UniTurn-48	UniTurn-54	
A	3326527336	3326527342	3326527348	3326507354	4+4mm lam. glass
A	3326518636	3326518642	3326518648	3326518654	Infill panel
B	3326527436	3326527442	3326527448	3326507354	4+4mm lam. glass
B	3326518736	3326518742	3326518748	3326518754	Infill panel
C	3326527336	3326527342	3326527348	3326507354	4+4mm lam. glass
C	3326518636	3326518642	3326518648	3326518654	Infill panel
D	530x1264mm	685x1264mm	840x1264mm	995x1264mm	3+3mm lam. glass
E	530x708mm	685x708mm	840x708mm	995x708mm	3+3mm lam. glass
F	875x2002mm	1055x2002mm	1231x2002mm	1408x2002mm	3+3mm lam. glass
G	923x2002mm	1073x2002mm	1223x2002mm	1373x2002mm	3+3mm lam. glass

Item A, B and C

State the internal height.

36 = 12 Ft. Diameter Door

42 = 14 Ft. Diameter Door

48 = 16 Ft. Diameter Door

54 = 18 Ft. Diameter Door

Remember - search for all parts online at www.besam-usa.com

© ASSA ABLOY Entrance Systems US Inc.

FASCIA SHEETS / WATER RESISTANT COVERS

The global leader in door opening solutions

Fascia sheets

Pos	UniTurn-36	UniTurn-42	UniTurn-48	UniTurn-54
A	3326511736	3326511742	3326511748	3326511754
B	3326511636	3326511642	3326511648	3326511654

State the canopy height.

Sizes

Pos	UniTurn-36	UniTurn-42	UniTurn-48	UniTurn-54
A Length	963	1120	1277	1434
B Length	1926	2241	2555	2869
Height	307 if CH is std 340 (H=CH-33)			

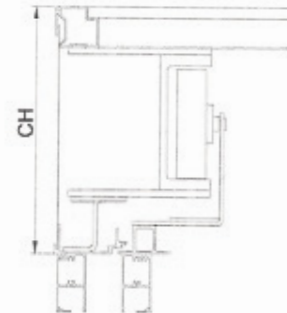
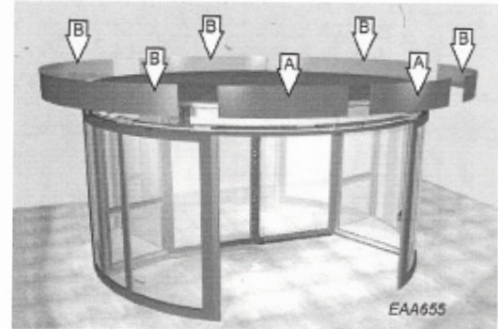

8.10 Water resistant cover

Ring 90°	Rubber 180°	Rubber 360°
1001102-18	1001100-18	1003914-18
1001102-21	1001100-21	1003914-21
1001102-24	1001100-24	1003914-24
1001102-27	1001100-27	1003914-27
1001102-30	1001100-30	1003914-30
1001102-36	1001100-36	1003914-36
1001102-42	1001100-42	1003914-42
1001102-48	1001100-48	1003914-48
1001102-54	1001100-54	1003914-54
1001102-62	1001100-62	1003914-62

1001104	Outlet water
724241	RXB 4,8x13 (12 pcs)
724191	RXB 4,8x32 (180° 30 pcs, 360° 60 pcs)

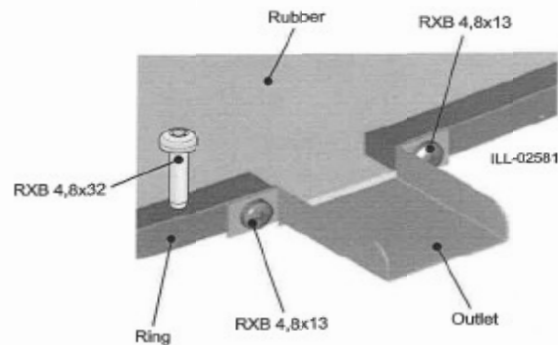

INTRO

The global leader in
door opening solutions

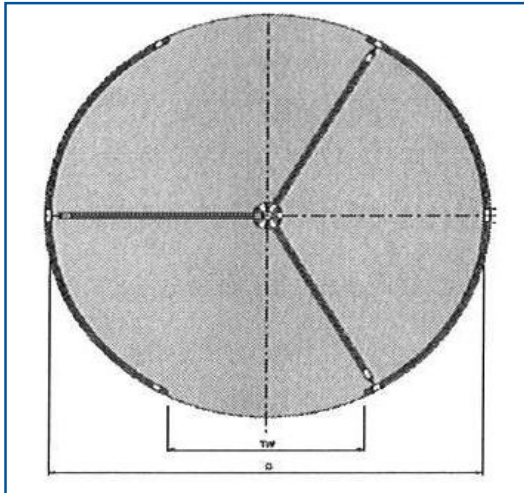

RD3M, RD3, RD3A1, KDB3, KDBW3

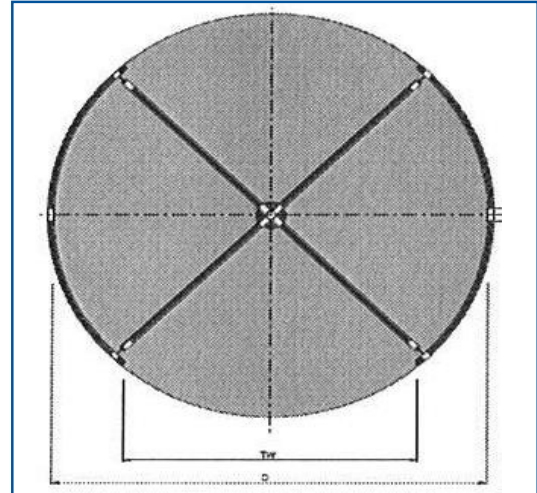

RD4M, RD4, RD4A1, RD4A2, KDB4,
KDBW4, KDBC

All RD3 or RD4 doors are center post type doors.

The “3” or “4” identifies if the door is a three wing or four wing door.

An “M” identifies the door as a Manual revolving door.

An “A” identifies the door as an Access control door.

A “1” or “2” identifies the door as a one-way Access control door or a two-way Access control door.

Older names are as follows:

RD3/4 = KDB3/4

RD3/4A1 = KDBW3/4

RD4A2 = KDBC

***** See Uniturn for additional Hardware items *****

Remember - search for all parts online at www.besam-usa.com

© ASSA ABLOY Entrance Systems US Inc.

RD SERIES

RD SERIES

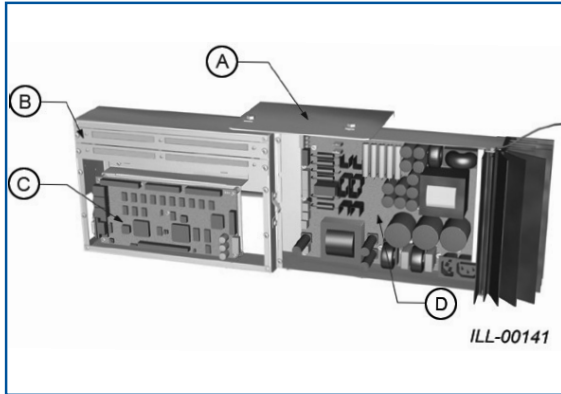

1001941 CDC Control Unit
Version 4.2 Complete (**A**)



CDC Control **Labeled Component Parts Follow:**

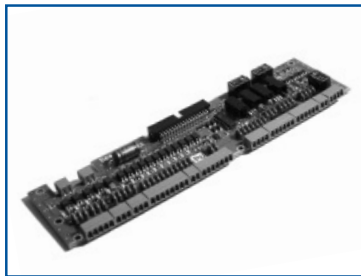

260040 IOA-board (**B**)

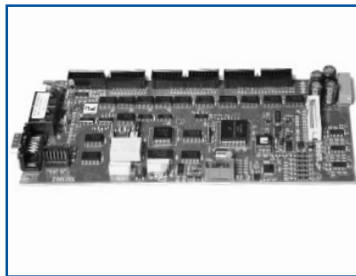

1001962 MPU-board (**C**)



655565 Power Supply
DPC-board (**D**)



**Labeled Component Parts
Follow:**

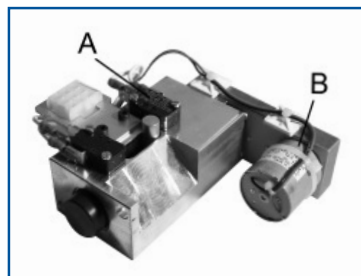

1001148 Electro-mechanical
Lock Unit



1001416 Connection Harness



USV3101D8 Micro Switch
No Arm (**A**)



1001180 Motor w/gearbox (**B**)



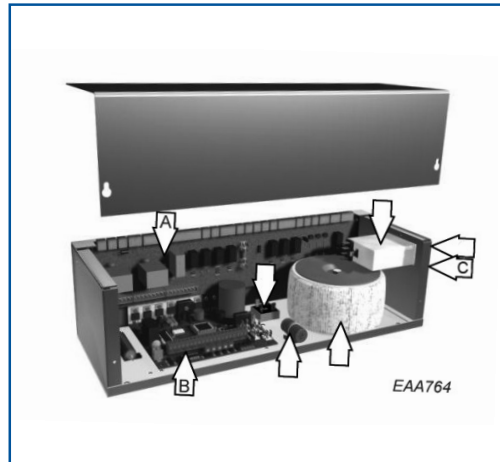

Control Box RD3 / RD4A1

Labeled Component Parts Follow:

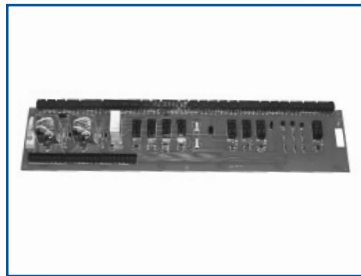

258553 I/O Board (A)

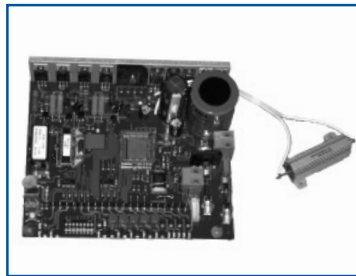

**262963 OPB Board without
E-prom (B)**



713561 Fuse 5 AT (115V) (C)



**713936 Fuse 1A (Slow)
I/O Board**



Remember - search for all parts online at www.besam-usa.com

© ASSA ABLOY Entrance Systems US Inc.

RD SERIES

ASSA ABLOY

The global leader in
door opening solutions

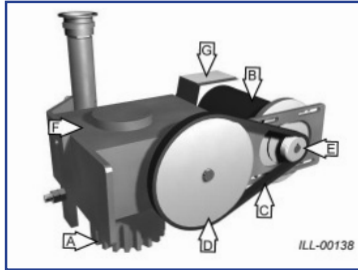

331001167 Drive Unit Complete, RD3/RD4



Labeled Component Parts Follow:

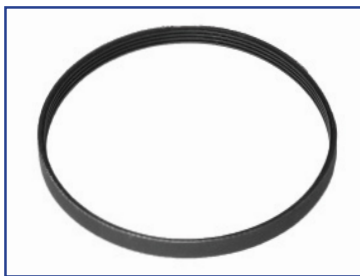

735272 V-Belt, 508 (C)



260785 Gear Box (F)



1001186 Cog Wheel (A)



245746 Pulley Wheel, 116mm (D)



248427 Carbon Brush Set (G)



243450 Center Plate Assembly



331700217 Motor Lenze (B)



245743 Pulley Wheel, 27mm (E)



1001153 Break Out Unit



1000993 Breakout Arm, Manual



phone: 888-732-3726

parts.na.besam@assaabloy.com

fax: 800-304-9459

© ASSA ABLOY Entrance Systems US Inc.

RD SERIES

ASSA ABLOY

The global leader in door opening solutions



1001177 Encoder & Slip Rings



1001165 Encoder



331001173 Fork, Breakout Release



331001174 Locking Ring Breakout Release

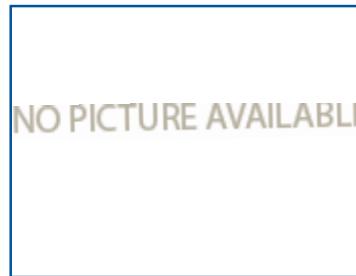

331700174 Slide Bearing - replaces 719170



248516 Bottom Bearing Kit Complete

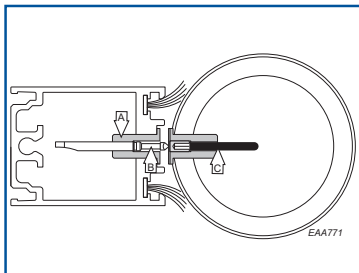

331001912 Cable Door Leaf



References (**A**) portion of Illustration

331700212 Round Spring Loaded Pin



References (**B**) portion of Illustration

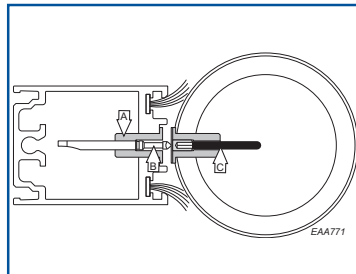

331001913 Cable Door Center Shaft



References (**C**) portion of Illustration



1003840 Kit, Connection Shaft-Door Leaf



331006772 Contact only



Remember - search for all parts online at www.besam-usa.com

© 2013 ASSA ABLOY Entrance Systems

BRUSHES

The global leader in door opening solutions

331001201 Brush Sealing, Vertical (**A**)



331001207 Brush Sealing, Top Horizontal (**B**)



331001113 Brush Sealing, Top Corner, 2-1/8" Bristles (**C**)



331001114 Brush Sealing, Bottom Corner, 2-1/8" Bristles (**D**)



1009107 Brush Sealing, Bottom Corner, Extended Length Bristles -2-1/2" (**D**)



331001208 Brush Sealing, Bottom Horizontal (**E**)



USTMB409496 Brush Sealing, Vertical (A), 3" Overall brush length. Special Order for when extra large gap needs filled.

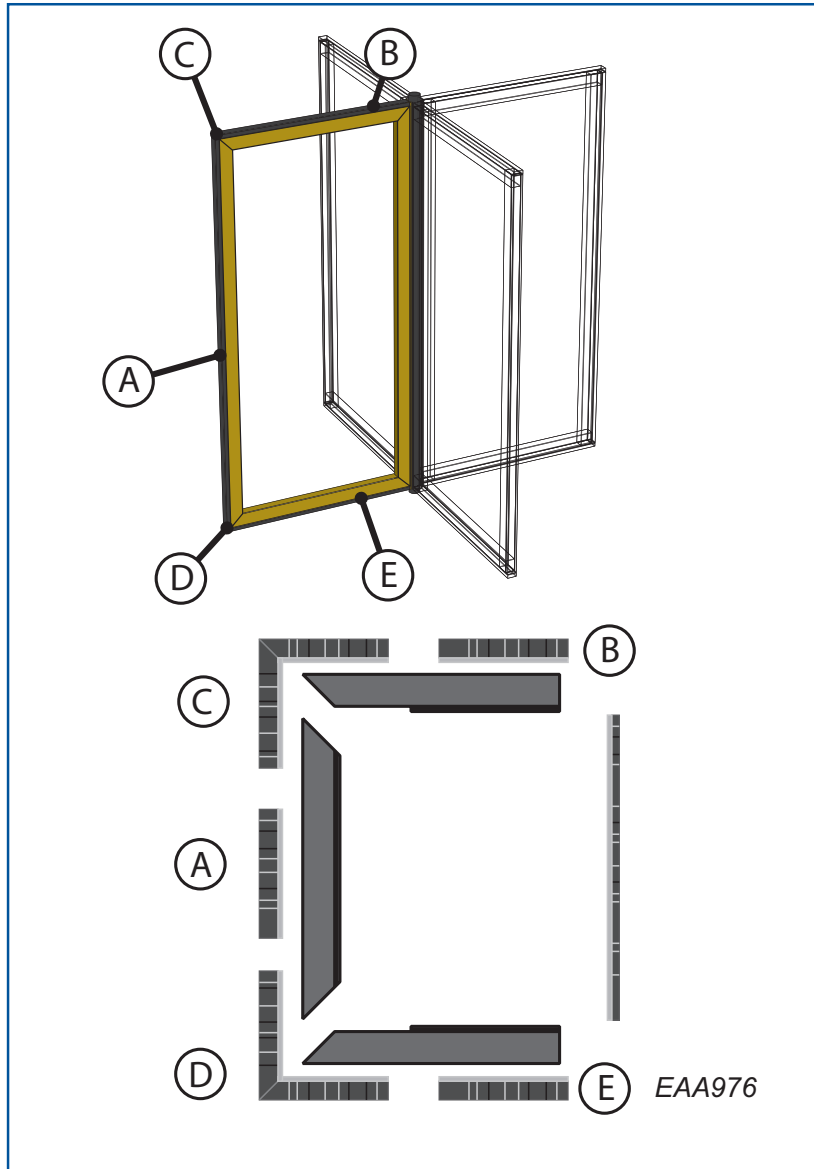

GLASS STOP

The global leader in door opening solutions

331001033 Glass Stop,
Vertical, Standard Height (A) *



331001034-36 Glass Stop,
Horizontal, 61 3/4"



716256 Vinyl, Thin, 1/4"



716256A Vinyl, Thick, 3/8"



* Specify floor to ceiling height
for over sized packages

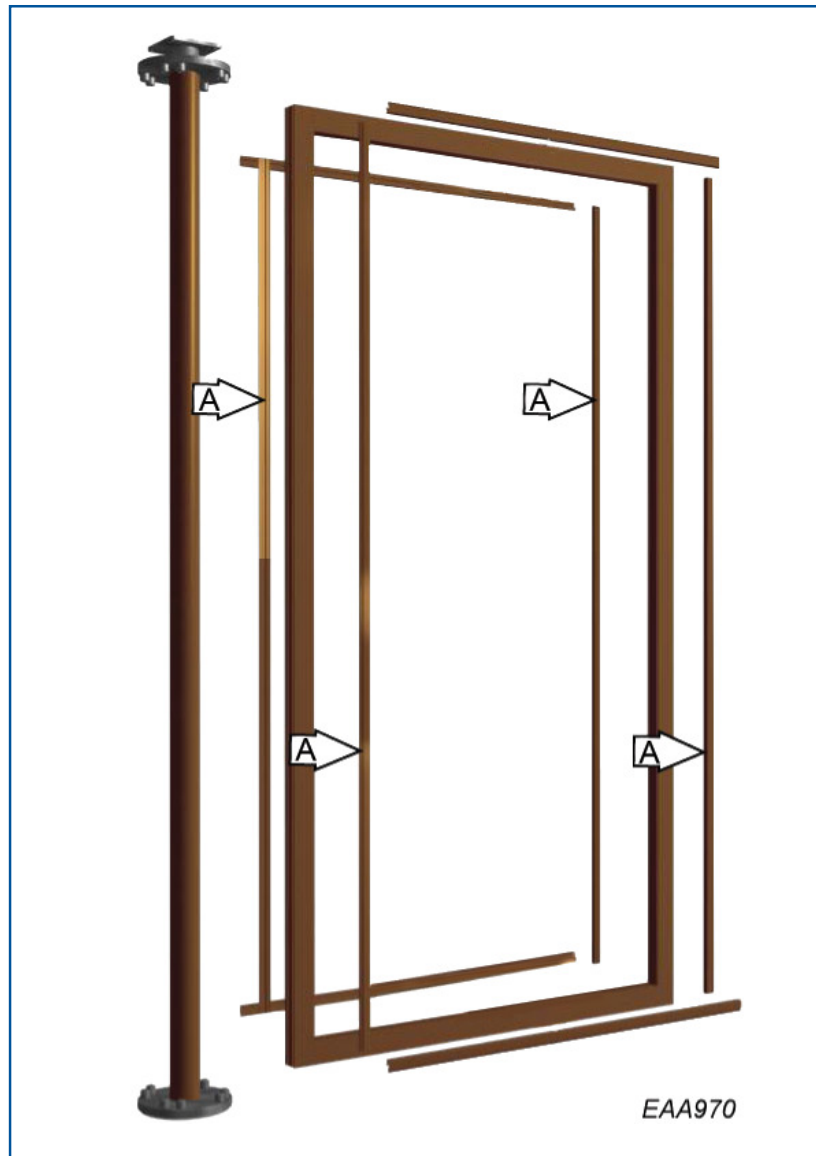

Remember - search for all parts online at www.besam-usa.com

© ASSA ABLOY Entrance Systems US Inc.

SAFETY EDGES

The global leader in door opening solutions

1001246 Safety Edge
Rotating, Vertical, 82 3/16" (**A**)



1001245-24 Safety Edge
Rotating, Horizontal 41" (**B**)



1001245-27 Safety Edge
Rotating, Horizontal 46 7/8" (**B**)



1001245-30 Safety Edge
Rotating, Horizontal 52 3/4" (**B**)



1001245-36 Safety Edge
Rotating, Horizontal 64 9/16" (**B**)



SAFETY EDGES

The global leader in door opening solutions

244961 Safety Edge Passive Standard



244961SPDX Safety Edge Passive *



244960 Safety Edge Active Standard



244960SPDX Safety Edge Active *



*** Information Required to place order:**

Internal floor to ceiling height in millimeters

This is a special order item with extended lead time. Call Service Parts for more information.



Remember - search for all parts online at www.besam-usa.com

© ASSA ABLOY Entrance Systems US Inc.

RD/RDA GLASS

The global leader in door opening solutions

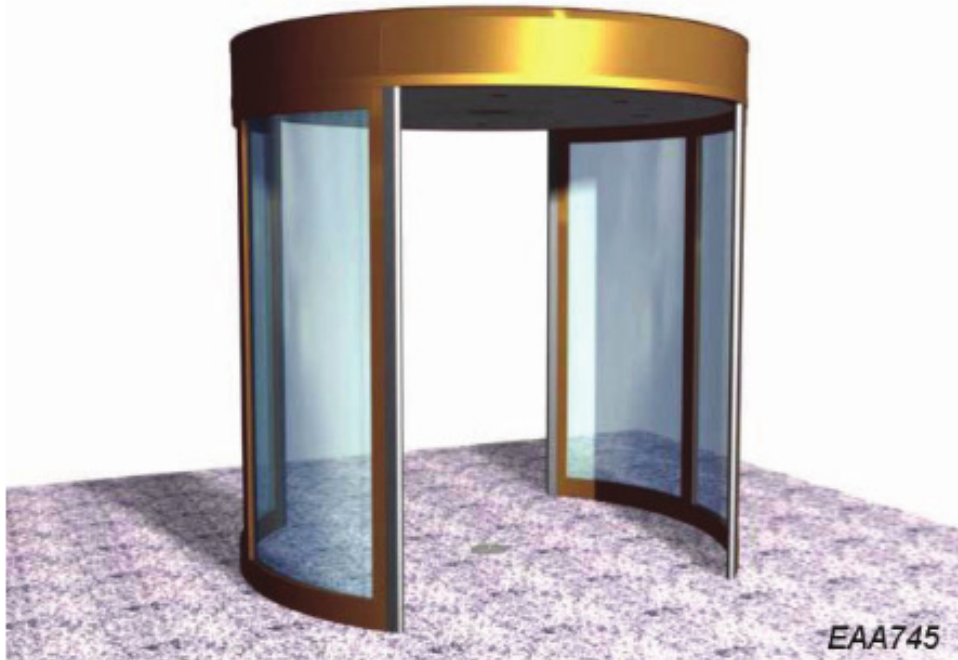

Outer walls 4+4mm laminated glass

RD3/4 Frame

3-18	3-21	3-24	3-27	3-30	3-36
331001002-18	331001002-21	331001002-24	331001002-27	331001002-30	331001002-36

4-18	4-21	4-24	4-27	4-30	4-36
331001003-18	331001003-21	331001003-24	331001003-27	331001003-30	331001003-36

RD3/4 Slim

3-18	3-21	3-24	3-27	3-30	3-36
331001324-18	331001324-21	331001324-24	331001324-27	331001324-30	331001324-36

4-18	4-21	4-24	4-27	4-30	4-36
331001325-18	331001325-21	331001325-24	331001325-27	331001325-30	331001325-36

State the internal height

-18 = 6 Ft -21 = 7 Ft -24 = 8 Ft
 -27 = 9 Ft -30 = 10 Ft -36 = 12 Ft

RD/RDA GLASS

The global leader in door opening solutions



Door leaves

RD3/4 Frame

Order flat glass from your local dealer

3+3mm laminated glass

Measures for doors with standard internal height (2200mm)

-18 (6')	-21 (7')	-24 (8')	-27 (9')	-30 (10')	-36 (12')
27-3/8" X 79-1/16"	33-1/4" X 79-1/16"	39-3/16" X 79-1/16"	45-1/16" X 79-1/16"	51" X 79-1/16"	62-13/16" X 79-1/16"

Remember - search for all parts online at www.besam-usa.com

© ASSA ABLOY Entrance Systems US Inc.

RD SERIES BRUSH SEALINGS

The global leader in door opening solutions

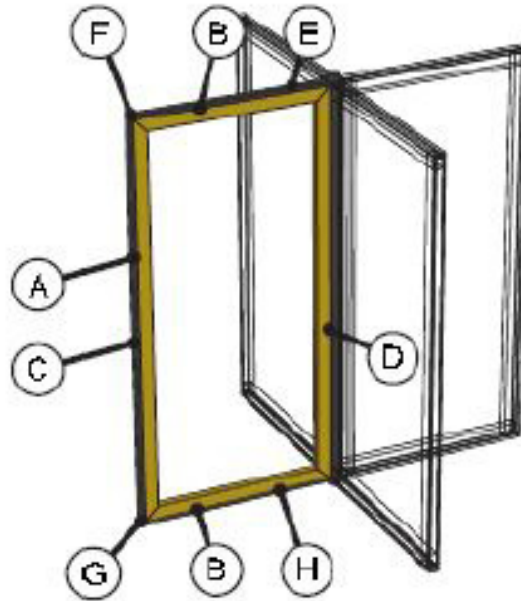

4.1 RD3/4 Frame

Pos	-18	-21	-24	-27	-30	-36
A	331001037	331001037	331001037	331001037	331001037	331001037
A-S ^a	331001037-S	331001037-S	331001037-S	331001037-S	331001037-S	331001037-S
B	331001036-18	331001036-21	331001036-24	331001036-27	331001036-30	331001036-36
C	331001201	331001201	331001201	331001201	331001201	331001201
D (Frame)	33716300	33716300	33716300	33716300	33716300	33716300
D (Slim)	33716277	33716277	33716277	33716277	33716277	33716277
E	331001207	331001207	331001207	331001207	331001207	331001207
F	331001113	331001113	331001113	331001113	331001113	331001113
G	331001114	331001114	331001114	331001114	331001114	331001114
H	331001208	331001208	331001208	331001208	331001208	331001208

a. For non-standard internal height.

Items E and H are delivered in fixed lengths, 1500 mm.

CEILING TILES

The global leader in door opening solutions

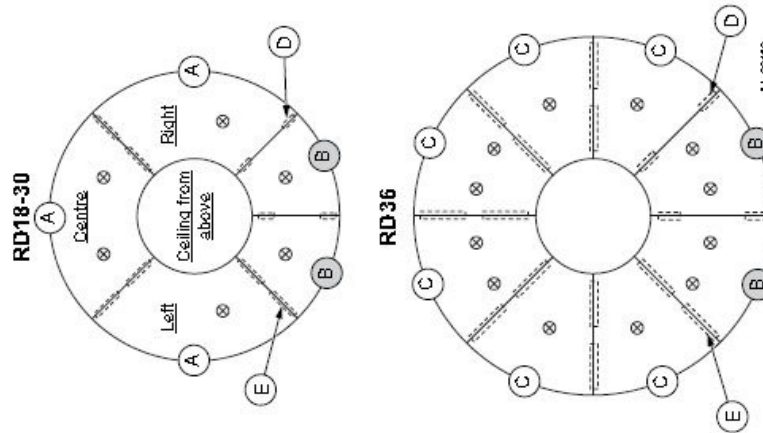

7.3 Ceiling panels

RD18-30

Ceiling panel "A" 331001054 hole for lights, please state:

- Centre (2 holes)
- Left or Right
- Downlight or Spotlight
- Surface treatment

Pos	RD18	RD21	RD24	RD27	RD30	RD36
A	331001054-18	331001054-21	331001054-24	331001054-27	331001054-30	
B	331001055-18	331001055-21	331001055-24	331001055-27	331001055-30	331001055-36
C						331001029-36
D (100 mm)	331001094	331001094	331001094	331001094	331001094	331001094
E (300 mm)	331001098	331001098	331001098	331001098	331001098	331001098

RD36

Ceiling panel "C" 331001029-36 hole for lights, please state:

- "C" two lights
- "C" one light
- Downlight or Spotlight
- Surface treatment

Remember - search for all parts online at www.besam-usa.com

© ASSA ABLOY Entrance Systems US Inc.

RDA SERIES

ASSA ABLOY

The global leader in
door opening solutions

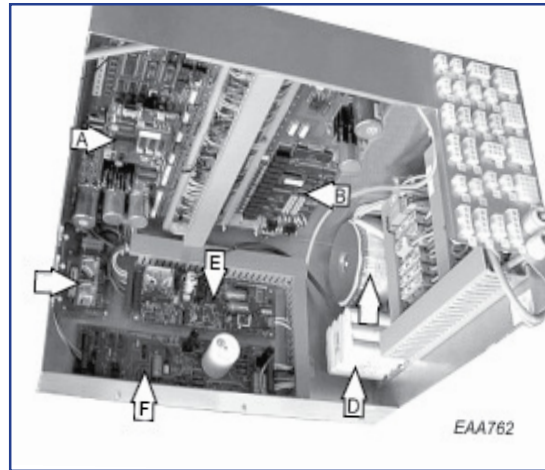

Control Box RD4A2 (OLD KDBC)

Labeled Component Parts Follow:

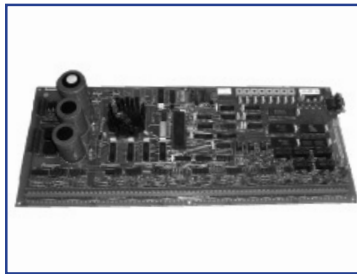

653677 Control, Main, PCB,
KDAC (**A**)

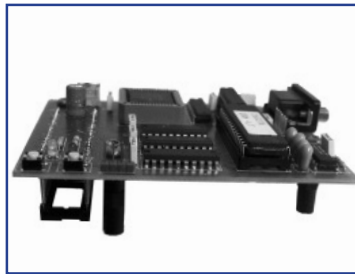

245874 Control, CRM
Piggyback KDAC

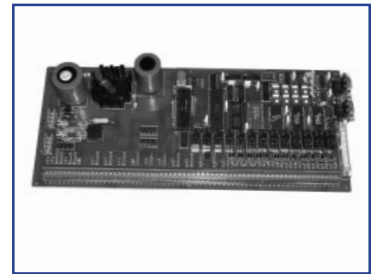

653679 Access Control Unit
ACU (**B**)

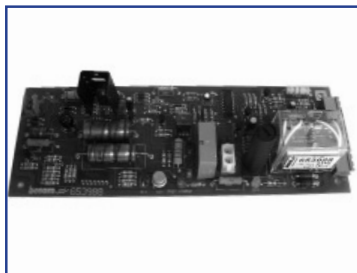

653988 Control, Battery Unit,
KDEU (**E**)



654184 Battery Backup, RDB,
KBDC (**D**)



653983 Control, Motor PC
Board, RDB (**F**)



Remember - search for all parts online at www.besam-usa.com

© ASSA ABLOY Entrance Systems US Inc.

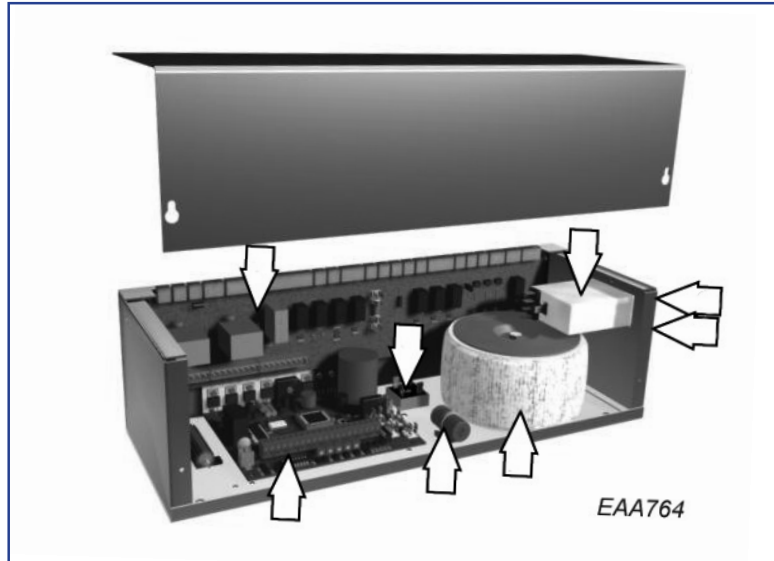

Control Box RD3 / RD4A1

KDBC/KDBW Control Unit

Access Control Boards Shown Below:

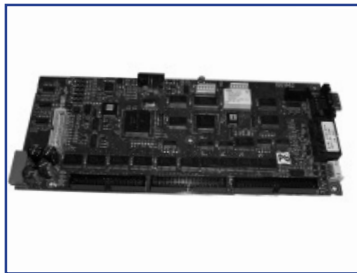

330000258 MPU Board
Access, Programmed

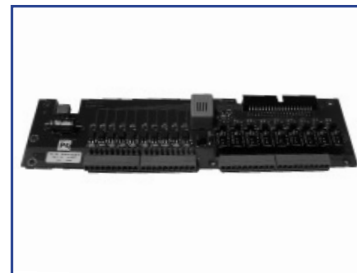

1003861 PC Board, IOB Board,
RD4A2



RDA SERIES

ASSA ABLOY

The global leader in door opening solutions

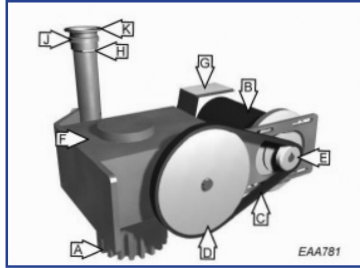

1001944 Drive Unit, 1-motor, KDBC/KDBW- RD3/RD4A



260786 Gearbox (F)



NOTE: 245988 is superseded by 331010525



245988 Motor, RDB/KD/CLB (B)



245988R Motor, Rebuild -O/S



331010525 Motor w/ Bracket (B)



331700217 Motor, Lenze



248427 Brush, Motor Lenze (G)



245746 Pulley, Gearbox, 116mm, KDB (D) -O/S



1003879 Pulley, 38 mm (D)



245744 Pulley, 57mm (E) -O/S



245743 Pulley, 27mm (E)



204142 Pinion Gear, KDB (A) O/S



1001186 Cog Gear, (A)



735130 Keyway for Pulley

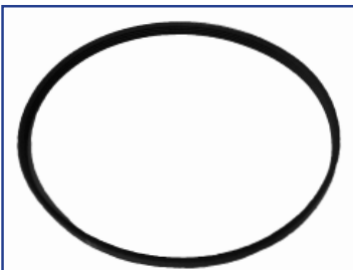

1700295 V-Belt L=381mm (C)



247771 Shaft, Motor Mounting, KDB



Remember - search for all parts online at www.besam-usa.com

© ASSA ABLOY Entrance Systems US Inc.

RDA SERIES

ASSA ABLOY

The global leader in
door opening solutions



247764 Lock Ring
(Red Steel Beam)



247762 Fork (KDB / KDBC)



331001174 Locking Ring,
Breakout Release
(Aluminum Beam)



331001173 Fork, Breakout
Release



732153 Locking Ring, Motor &
Gearbox (KDB / KDBC)



33263408 Lock, Electro-
Mechanical, Gearbox (KDB /
KDBC)



1001046 Pin, Door Leaf, RD



1000993 Breakout Arm RDA



331701327 Sensor, SRST-1
(LZR100)



phone: 888-732-3726

parts.na.besam@assaabloy.com

fax: 800-304-9459

© ASSA ABLOY Entrance Systems US Inc.

RDA SERIES

ASSA ABLOY

The global leader in door opening solutions



262136 Switch, PCD



264612 Key only

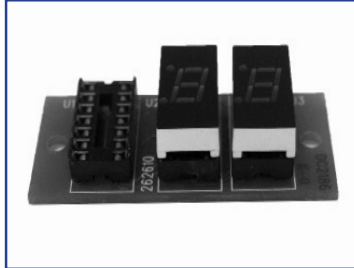

262610 Board, Display, LED

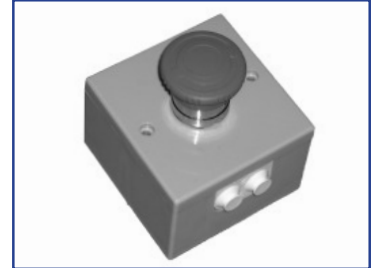

653727 Emergency Unit Button, EBL



262529 Emergency Stop Button, Standard



331002216 Emergency Open, Surface Mount



331002439 Stop Switch, Emergency, New



331700069 Cover, Stop, Emergency



331002217 Evacuate, Flush Mounted



1702239 E-Stop Button



1702454 Spacer, 5/8", for above



Remember - search for all parts online at www.besam-usa.com

© ASSA ABLOY Entrance Systems US Inc.

RDA SERIES

ASSA ABLOY

The global leader in door opening solutions

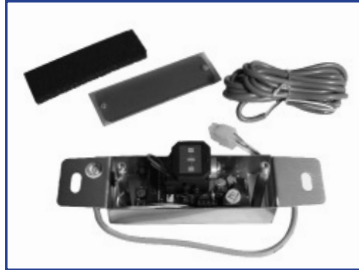

264300 DSR Unit Activator



714135 Sensor, MR3



10.1026 Hub Blackhawk w/ Transformer



10.1030 Sensor only, Blackhawk, Presence



AGC-M3MS Audio Player, Digital, RD4A

Replaced by **AGC533**

AGC533 Audio Player, Digital, RD4A



260764 Mat, Dummy, 6 Ft.



260765 Mat, Contact, 7 Ft., KDAC



260766 Mat, Contact, 4 Wing, 8 Ft., KDBW



1010399 Label, Escape Button, RD/RDA



254227 Sensor, PIR Activation



715442 Transformer, for Lights



RDA SERIES

ASSA ABLOY

The global leader in
door opening solutions



707608 Spotlight Housing
w/ Halogen Bulb - *Replaced by*
331010688

331010688 Spotlight Housing
w/ LED Bulb



707633 Spotlight Bulb, 20W



Obsolete when supply exhausted



713974 Rectifier, 24V



1702145 Lamp, LED 5W 12V
for 331010688 above

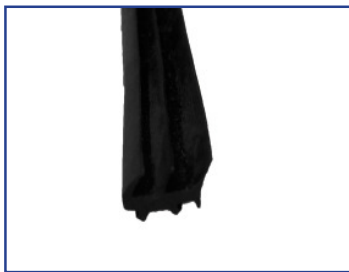

716256A Vinyl, Thick, 3/8"



716268 Vinyl, Curved Glass,
Standard



713936 Fuse, 1,0 AT (slow)



714003 Fuse, 1,5 Amp, 125V



713484 Fuse, 3,0 AT (slow)



713561 Fuse, 5,0 AT (slow)



716300 Felt, Grey



716256 Vinyl, Thin, 1/4"



Remember - search for all parts online at www.besam-usa.com

© ASSA ABLOY Entrance Systems US Inc.

SECURE360

The global leader in door opening solutions



US02-1717-02 Secure360 Sensor Head Box*



US02-1717-03 Secure360 Processor*

No longer available- contact Revolver Tech Support



US15-1717-02 Secure360 Router & Access I/O Module Kit



*Revolver department **MUST** approve prior to ordering either of the above items. **ALL** orders **MUST** include:

1. Identify the replaced Processor serial number (field tech to provide).
2. Job name.
3. Sensor serial number (provided from field tech)
4. Approval from Revolver department personnel.

Special Core Return Tag sent with shipment. (Core charge will be invoiced immediately and credited upon return)



US15-1717-01 Secure360 Cable Kit



1001108 Bulb, 10W 12V 21 Degree



USBALED4D30 Bulb, 6W Daylight, 30 Degree
Replaced by 1702145



AGC533EU Voice Annunciator w/ Europe Plug or Adaptor - Req'd for SPT360



1011412 Kit, UPS Power Supply w/Bracket kit



1702259 UPS Power Supply, Replacement



1011521 Bracket Kit, UPS Power Supply, Replacement



1702260 Step-Down Transformer, Replacement



SECURE360

The global leader in door opening solutions



1010550* Sensor Low SPT360
1-Way Complete less ceiling tiles.

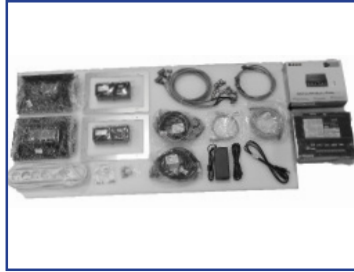

1010551* Sensor Low SPT360
2-Way Complete less ceiling tiles.



1010642* Sensor Medium SPT360
1-Way Complete less ceiling tiles.



Ceiling Tile Template Required for Retrofit and a replacement MCU board may also be needed, contact Technical Services for details.

*Not available to Distribution at this time.



1010641* Sensor Medium SPT360
2-Way Complete less ceiling tiles.



1010647* Sensor High SPT360
1-Way Complete less ceiling tiles.



1010646* Sensor High SPT360
2-Way Complete less ceiling tiles.



Ceiling Tile Template Required for Retrofit and a replacement MCU board may also be needed, contact Technical Services for details.

*Not available to Distribution at this time.



1702096 Control Box SPT360-C



1702055 Sensor SPT360-S
(2 required for 2-Way system)



1702097 Network Switch D-Link



Remember - search for all parts online at www.besam-usa.com

© ASSA ABLOY Entrance Systems US Inc.

SECURE360

The global leader in door opening solutions



1702122 Transformer
100-240VAC/24VDC



1702123 Transformer Power Cable



1702095 Cable Kit SPT360
(2 req'd for 2-Way system)



1700954 Cable RJ45- 1 Meter
(Left picture)



1700955 Cable RJ45- 5 Meter
(Right picture)



1010378 Cable Encoder SPT360



1010341 Cable Set 1-Way
SPT360



1010342 Cable Set 2-Way
SPT360 (Shown)

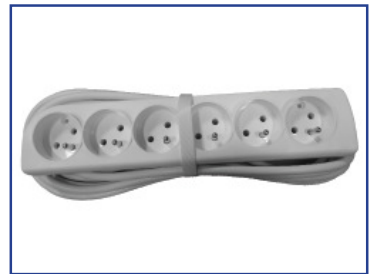

1700949 Main Outlet 4-6 Sockets

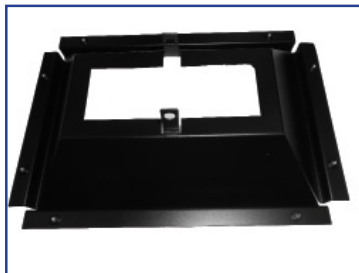

1010546 Holder, Sensor, Low



1010552 Holder, Sensor, High



1010568 Holder, Sensor, Medium



Add:
1011569,1011570,1011571
templates

724456 Replacement Screw for
mounting Sensor to Holder



1702124 Replacement Screw for
mounting Cover Plate to Holder



1010548 Cover Plate, Sensor, Low



1010569 Cover Plate, Sensor, Medium



1010554 Cover Plate, Sensor, High



RDA SERIES

BRUSHES

The global leader in door opening solutions

331001037 Vertical Brush holder (A)



331001036-XX Horizontal Brush holder (B)



-18 / 6 Ft



-21/ 7 Ft



-24/ 8 Ft

331001200 Vertical Brush (C) **



716300 Grey Felt (D)



331001206 Horizontal Brush (E)



331001112 Corner Brush (F)



Item E is delivered in fixed length of 59" - 1500mm.

Item A & B are Rubber fixing profiles.

Item B: State if break-out kit installed.

Item A, C and D - MUST state the internal height of the revolver being installed on.

** **1009106** Vertical Brush -Alternate for (C) with 2-1/2" long bristles

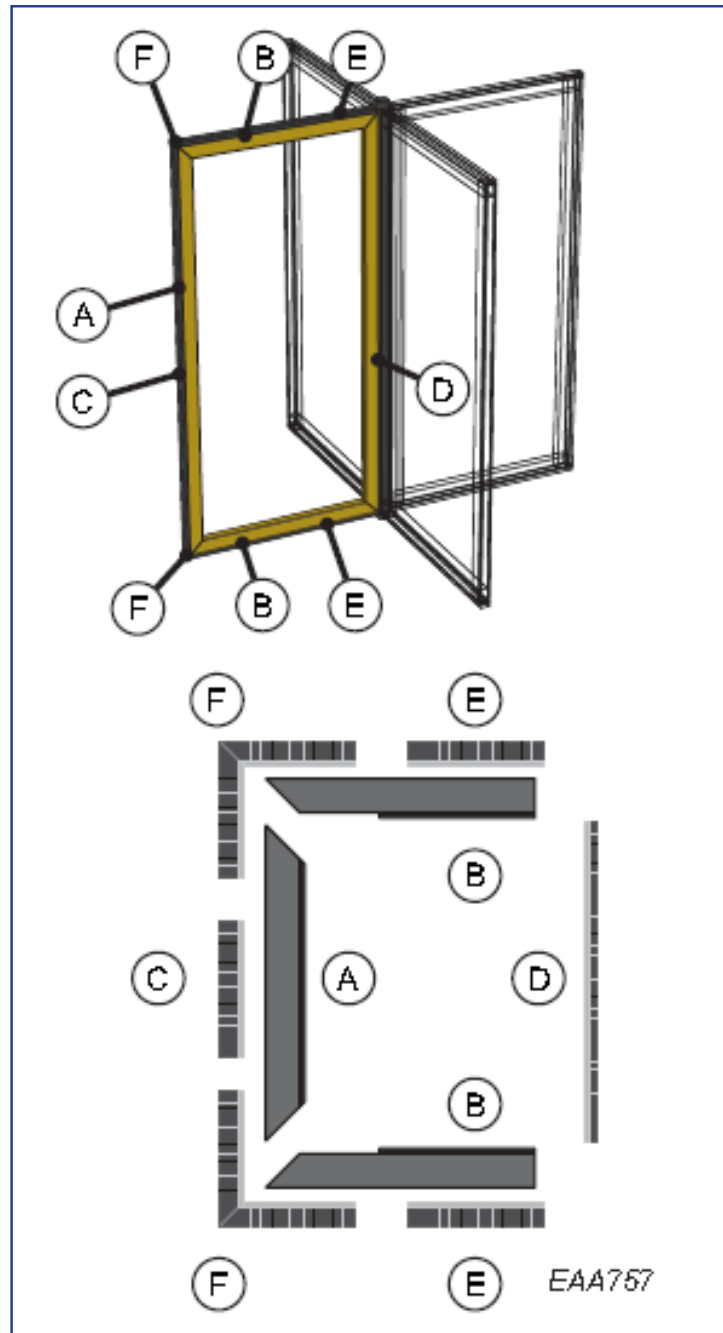

Remember - search for all parts online at www.besam-usa.com

© ASSA ABLOY Entrance Systems US Inc.



1005229 Control Unit, SW100



1005230 Speed Control, SW100



1005232 Drive Unit, SW100



1005280 Position Assembly, SW100

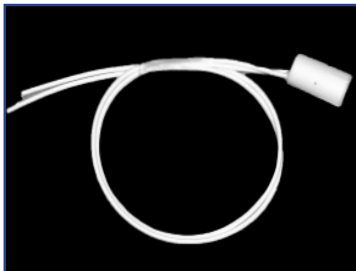

1005283 Switch, Magnet, SW100



1006483 Kit, Floor Lock, Set of 2

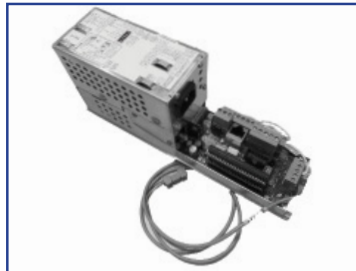

1011130 Control Unit, Return to Home Function



330000233 Cable, Encoder for SW100



331009105 for 1011132



1011132 Transmission Unit, Return to Home Function

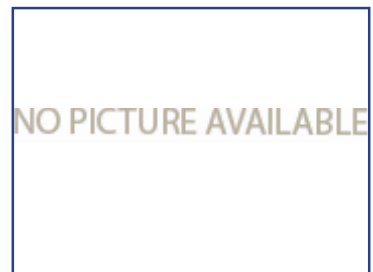

USSK104203480A Set, Rubber & Felt Weatherstripping for 8' unit as used on International Revolvers



Remember - search for all parts online at www.besam-usa.com

© ASSA ABLOY Entrance Systems US Inc.



21-03-207 Shaft Extension, 70mm, w/Screw & Sleeve



USBI6006-2RS Bearing, 6006-2RS



331001207 Brush, Horiz, Floor



331001206 Brush, Horiz, Ceiling



331001200 Brush, Vertical



331001112 Brush, Corner, Ceiling



1007161 Brush, Corner, Floor



1006490 Breakout Arm Assembly RDXM



21-03-205 Shaft Extension, 20mm, w/Screw & Sleeve



PUSHBAR6 Pushbar, #8 SS, 1" Dia, for 6', RH



PUSHBAR7 Pushbar, #8 SS, 1" Dia, for 7', RH



PUSHBAR8 Pushbar, #8 SS, 1" Dia, for 8', RH



****Special Order Item****

Return to Home

1012706-18 Drive & Control Unit w/ Center Beam Unit, 6 Ft



1012706-21 Drive & Control Unit w/ Center Beam Unit, 7 Ft



1012706-24 Drive & Control Unit w/ Center Beam Unit, 8 Ft



21-03-206 Shaft Extension, 50mm, w/Screw & Sleeve



1005284 Position Block, Switch



TABLE OF CONTENTS

The global leader in
door opening solutions

Extrusions

- Extrusion Guide Introduction
 - Extrusions
 - UniSlide Header
 - ICU/CCU Header
 - Swing Door Headers
 - Frames / Transom
 - Door Vertical Rails
 - Door Horizontal Rails
 - Threshold
 - Besam SL500
 - Besam SL500 T67 Tele

EXTRUSION GUIDE INTRODUCTION

The global leader in
door opening solutions

Extrusion Guide

This section includes commonly used extrusions for Besam equipment and is divided by equipment header, frames/transom, door vertical rails, door horizontal rails and thresholds. Extrusions are available for currently manufactured varieties of Besam equipment.

Glossary of finish terms:

- CL = clear
- DB = dark bronze
- BK = black
- MF = mill

Refer to your most recent extrusion price list for per order charges for cut and prep.

Information Required for Extrusion Orders*	
All Extrusions <ul style="list-style-type: none"> - Extrusion part # - Extrusion description - Finish - Length - Build to the following project # (if applicable) - Prepped/Unprepped 	Door Carriers – UniSlide/ICU <ul style="list-style-type: none"> - Include carriage wheels - Single slide/bi-part - Hand <ul style="list-style-type: none"> o If telescopic, leaf #1 or #2 - FBO/FSL - Carrier width
Jamb Tubes/Slick Tubes <ul style="list-style-type: none"> - Threshold undercut (y/n) <ul style="list-style-type: none"> o If yes, threshold type 	Glass Stop <ul style="list-style-type: none"> - With vinyl/without vinyl
Rails <ul style="list-style-type: none"> - Type of ball catch - Type of lock prep - Clips in bottom rail (y/n) - Supply lock on rail - Hand - Active leaf/sidelite - FBO/FSL 	UniSlide Cover/Sensor Plank Cap <ul style="list-style-type: none"> - Prepped for 5-position switch in cover (y/n) - Prepped for UltraView sensor in cover (y/n)
* You may use the class 3 extrusion order form or follow this sheet as a guide.	

UNISLIDE HEADER

The global leader in door opening solutions

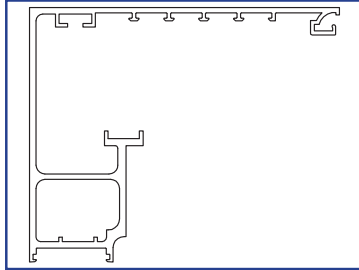

US01-1260-LLCL Plankless Beam, Standard**



US01-1260-LLDB Plankless Beam, Standard**



**Used with standard UniSlide overhead concealed, CGL and surface mount (except for packages with sidelites)

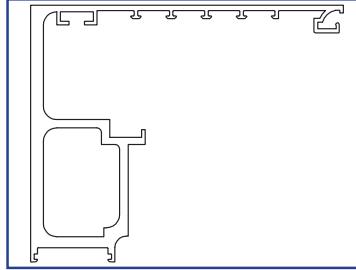

US01-1261-LLCL Plankless Heavy Beam**



US01-1261-LLDB Plankless Heavy Beam**



**Required for standard and CGL UniSlide over 12'6"

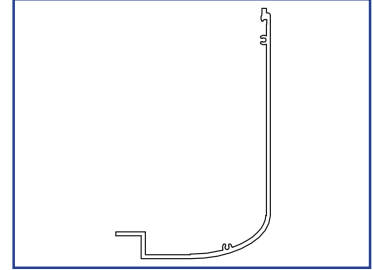

US01-1262-LLCL PL & PLH Cover



US01-1262-LLDB PL & PLH Cover

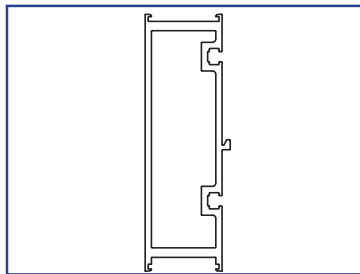

US01-0294-LLCL Plank



US01-0294-LLDB Plank

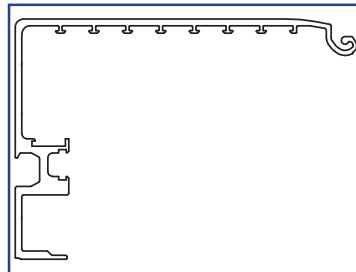

US01-0520-LLMF Beam, Telescopic**



**Required for all Resilience and Telescopic packages. Refer to Marketing Bulletin #439

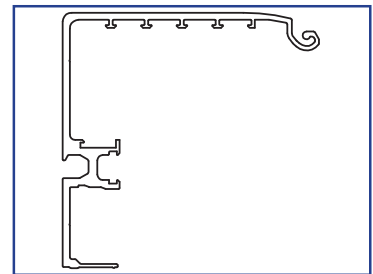

US01-0295-LLMF Beam **



**Required for all Resilience and Telescopic packages. Refer to Marketing Bulletin #439

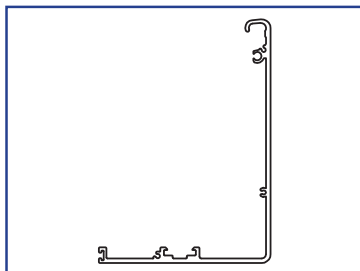

US01-0597-LLMF Clad Cover

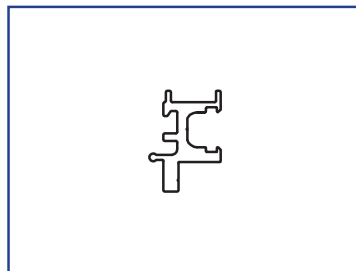

US01-0610-LLMF Track, Telescopic

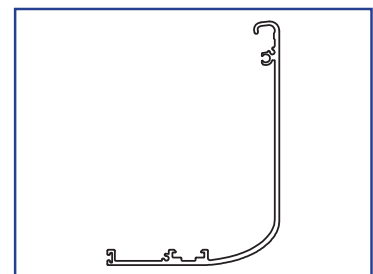

US01-0296-LLCL Cover, UniSlide



US01-0296-LLDB Cover, UniSlide



UNISLIDE HEADER

The global leader in door opening solutions

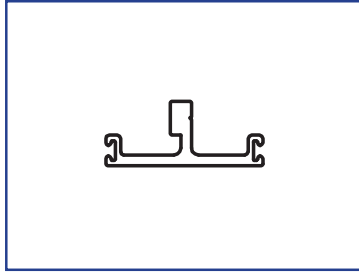

US01-0611-LLCL Lower Edge, Telescopic



US01-0611-LLDB Lower Edge, Telescopic

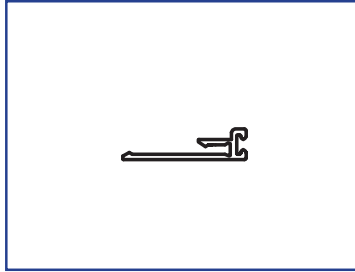

US01-0353-LLCL Beam, Extension



US01-0353-LLDB Beam, Extension

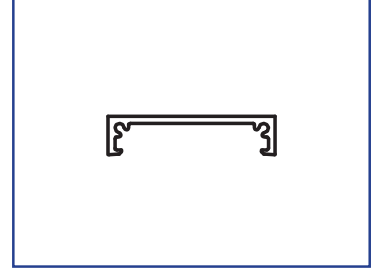

US01-0331-LLCL Sensor Channel, Surface Applied



US01-0331-LLDB Sensor Channel, Surface Applied

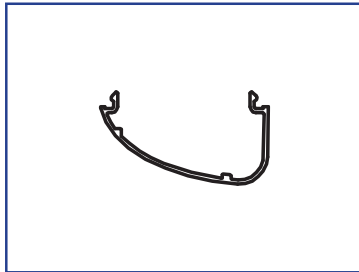

US01-0326-LLCL Sensor Plank Cap



US01-0326-LLDB Sensor Plank Cap

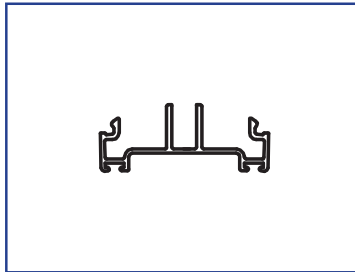

US01-0352-LLCL Plank Cap, FSL/FBO



US01-0352-LLDB Plank Cap, FSL/FBO

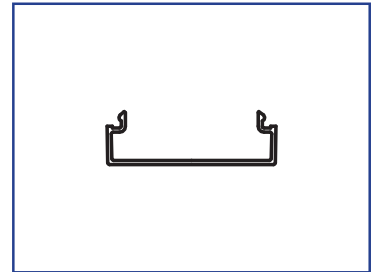

US01-0299-LLCL Square Plank Cap



US01-0299-LLDB Square Plank Cap



Remember - search for all parts online at www.besam-usa.com

© ASSA ABLOY Entrance Systems US Inc.

SL500 HEADER

The global leader in door opening solutions

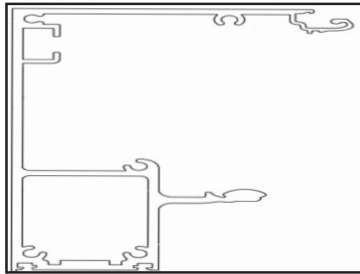

1007044-LLCL Beam 178, CLR, SL500



1007044-LLDB Beam 178, DB, SL500

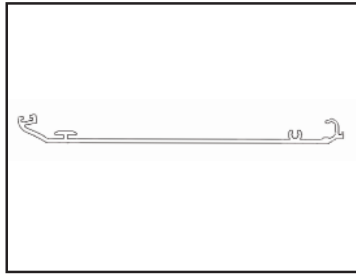

1007366-LLCL Beam Cover, CLR, SL500



1007366-LLDB Beam Cover, DB, SL500

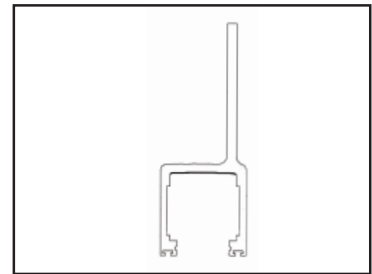

1007361-LLCL Carrier, CLR, SL500



1007361-LLDB Carrier, DB, SL500



ICU/CCU HEADER

The global leader in door opening solutions

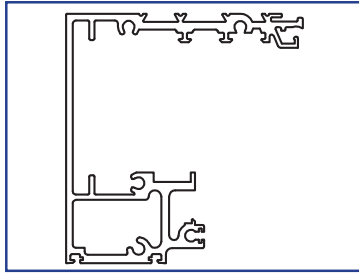

US01-0585-LLCL Beam

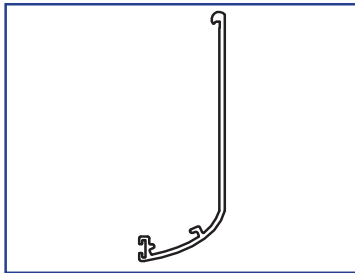

US01-0586-LLCL Cover

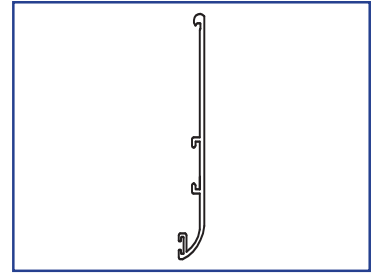

US01-0559-LLCL Cover,
Telescopic

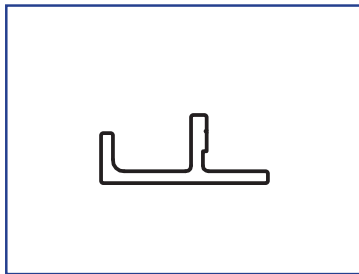

US01-0560-LLCL Lower Edge,
Telescopic

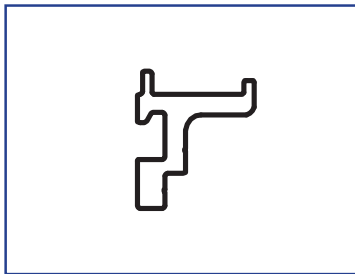

US01-0561-LLMF Track,
Telescopic

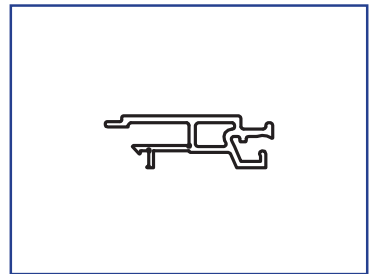

US01-0588-LLCL Beam
Extension, Telescopic

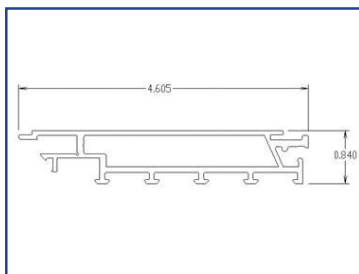

US01-1697-LLCL Auto Header
Extension, CL

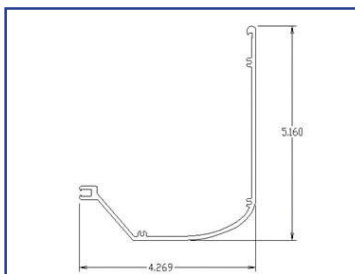

US01-1698-LLCL Auto Header
Cover, CL

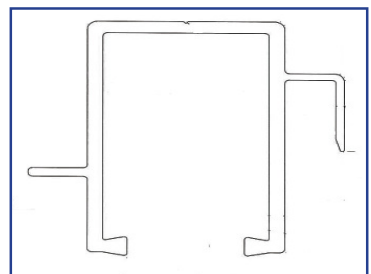

US01-2001-LLMF ICU Track,
Mill Finish



ICU/CCU HEADER

The global leader in
door opening solutions

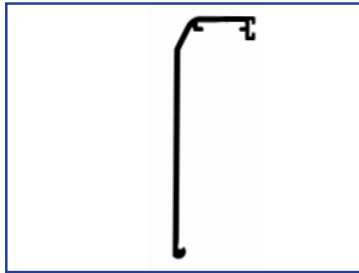

1011529-LLCL ICU VersaMax
Cover, CL

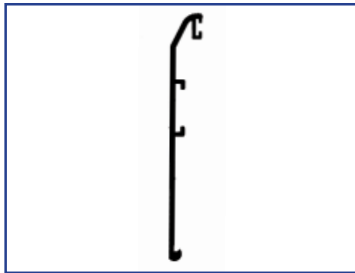

1011530-LLCL ICU Telescopic
Cover, CL

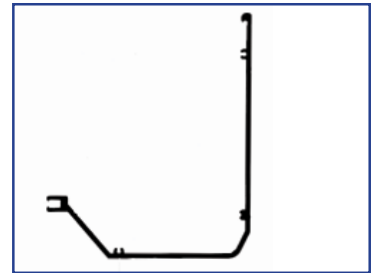

1011531-LLCL ICU Auto.Hdr.
Cover, CL



SWING DOOR HEADERS

The global leader in door opening solutions

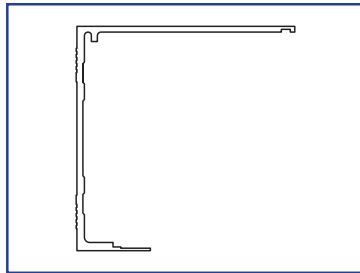

US01-0440-LLCL Fixed Cover, Swingmaster

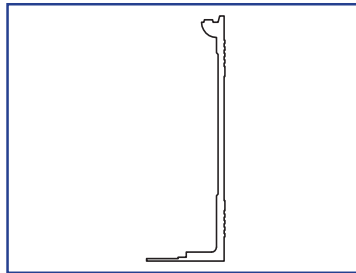

US01-0441-LLCL Removable Cover, Swingmaster

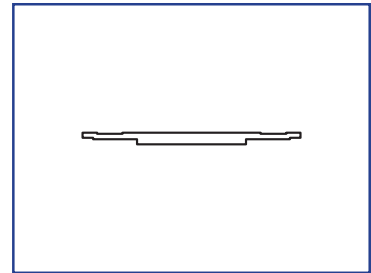

US01-0442-LLCL Center Strip, Swingmaster



US01-0440-LLDB Fixed Cover, Swingmaster



US01-0441-LLDB Removable Cover, Swingmaster



US01-0442-LLDB Center Strip, Swingmaster

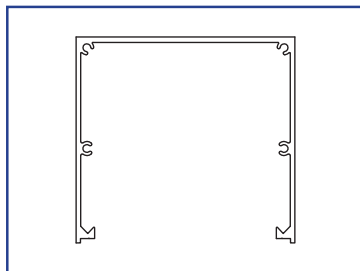

US01-0594-LLCL Bottom Load, Header, Swingmaster

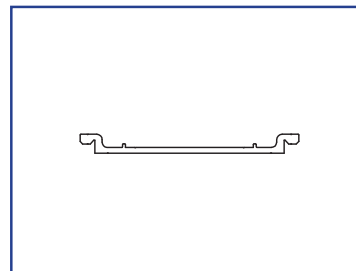

US01-0593-LLCL Motor Mount, Bottom Load, Swingmaster

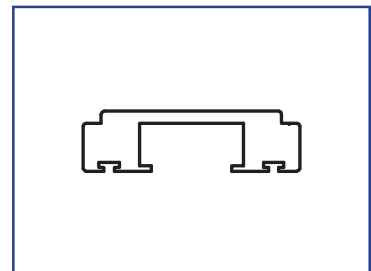

US01-0460-LLCL Track, Ready-Fold



US01-0594-LLDB Bottom Load, Header, Swingmaster



US01-0460-LLDB Track, Ready-Fold



SWING DOOR HEADERS

The global leader in door opening solutions

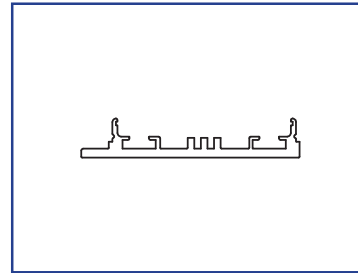
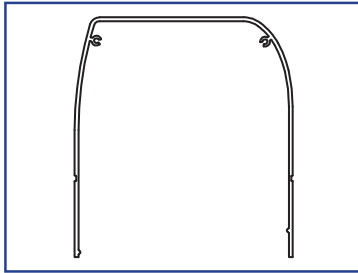

US04-1402-3925CL Cover, 39.25", CL, SW100/PS



US04-0505-3925CL Back Plate, 39.25", CL, SW100/PS



US04-1402-3925DB Cover, 39.25", DB, SW100/PS



US04-0505-3925DB Back Plate, 39.25", DB, SW100/PS



US04-1402-51CL Cover, 51", CL, SW100/PS



US04-0505-51CL Back Plate, 51", CL, SW100/PS



US04-1402-51DB Cover, 51", DB, SW100/PS



US04-0505-51DB Back Plate, 51", DB, SW100/PS



US04-1402-99CL Cover, 99", CL, SW100/PS



US04-0505-99CL Back Plate, 99", CL, SW100/PS



US04-1402-99DB Cover, 99", DB, SW100/PS



US04-0505-99DB Back Plate, 99", DB, SW100/PS



US04-1402-13CL Cover, 13', CL, SW100/PS



US04-0505-13CL Back Plate, 13', CL, SW100/PS



US04-1402-13DB Cover, 13', DB, SW100/PS



US04-0505-13DB Back Plate, 13', DB, SW100/PS



Remember - search for all parts online at www.besam-usa.com

© ASSA ABLOY Entrance Systems US Inc.

SWING DOOR HEADERS

The global leader in door opening solutions

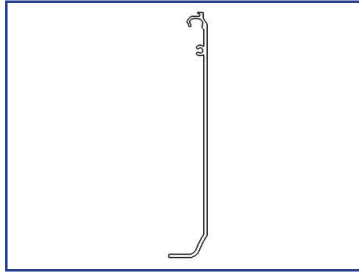

1008589-LLCL Extrusion, Head Box Cover, OHC, Side Load, SW200i, Clear



1008589-LLDB Extrusion, Head Box Cover, OHC, Side Load, SW200i, Dark Bronze

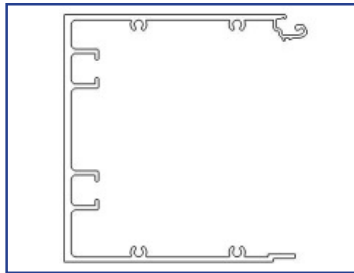

1008588-LLCL Extrusion, Head Box Beam, OHC, Side Load, SW200i, Clear



1008588-LLDB Extrusion, Head Box Beam, OHC, Side Load, SW200i, Dark Bronze

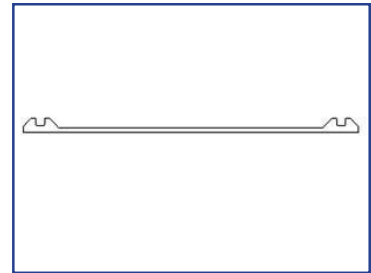

1008593-LLCL Extrusion, Head Box Cover, OHC, Bottom Load, SW200i, Clear



1008593-LLDB Extrusion, Head Box Cover, OHC, Bottom Load, SW200i, Dark Bronze

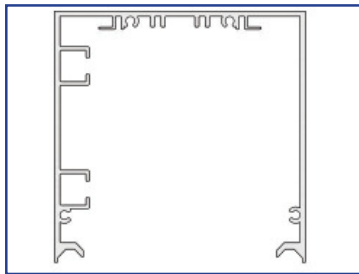

1008592-LLCL Extrusion, Head Box Beam, OHC, Bottom Load, SW200i, Clear



1008592-LLDB Extrusion, Head Box Beam, OHC, Bottom Load, SW200i, Dark Bronze

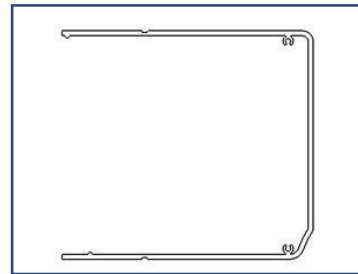

1008750-3925CL Extrusion, Cover, S/A, SW200i, SW100, P/S, 39.25" Clear



1008750-3925DB Extrusion, Cover, S/A, SW200i, SW100, P/S, 39.25" DB



1008750-51CL Extrusion, Cover, S/A, SW200i, SW100, P/S, 51" Clear



1008750-51DB Extrusion, Cover, S/A, SW200i, SW100, P/S, 51" Dark Bronze



1008750-99CL Extrusion, Cover, S/A, SW200i, SW100, P/S, 99" Clear



1008750-99DB Extrusion, Cover, S/A, SW200i, SW100, P/S, 99" Dark Bronze



FRAMES/TRANSOM

The global leader in door opening solutions

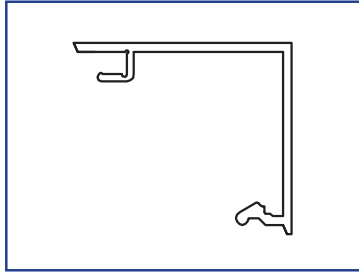

US01-0937-LLCL Surface Applied Filler Tube



US01-0937-LLDB Surface Applied Filler Tube

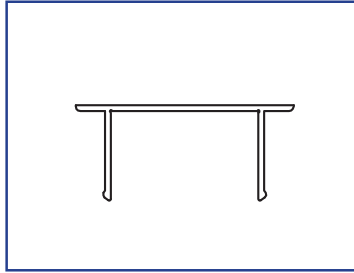

US01-0933-LLCL Redesigned Jamb Filler



US01-0933-LLDB Redesigned Jamb Filler

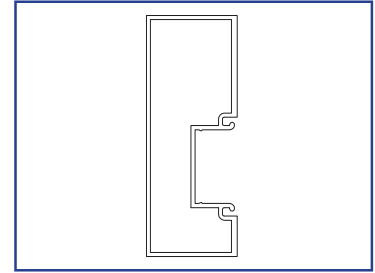

US01-0931-LLCL Redesigned Jamb Tube **



US01-0931-LLDB Redesigned Jamb Tube **



** Refer to marketing bulletin #433

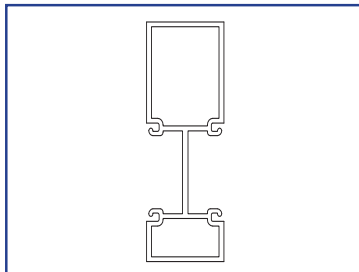

US01-0934-LLCL Redesigned Mullion Tube



US01-0934-LLDB Redesigned Mullion Tube

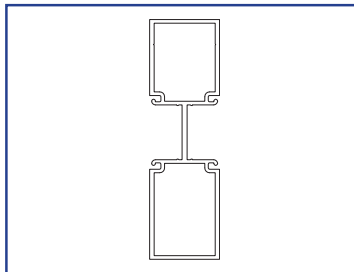

US01-0979-LLCL Redesigned 6" Jamb Tube



US01-0979-LLDB Redesigned 6" Jamb Tube

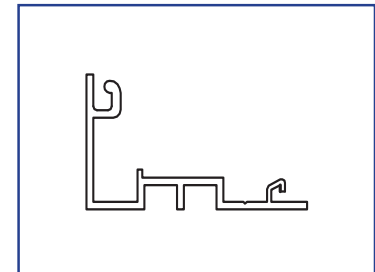

US01-0935-LLCL Redesigned Transom Header Gutter



US01-0935-LLDB Redesigned Transom Header Gutter



Remember - search for all parts online at www.besam-usa.com

© ASSA ABLOY Entrance Systems US Inc.

FRAMES/TRANSOM

The global leader in door opening solutions

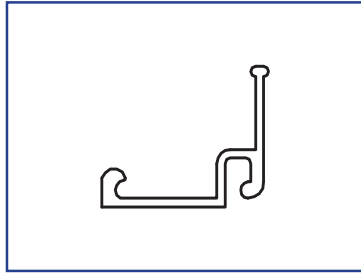

US01-0932-LLCL Redesigned 1/4" Snap, New



US01-0932-LLDB Redesigned 1/4" Snap, New

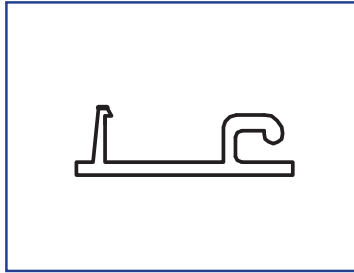

US01-0936-LLCL Redesigned Transom Header Snap



US01-0936-LLDB Redesigned Transom Header Snap

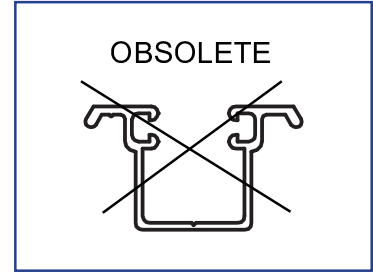

US01-0430-LLCL Jamb Closure

US01-0430-LLDB Jamb Closure

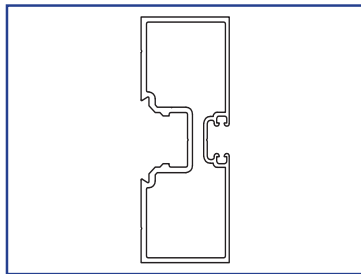

US01-0425-LLCL 4 1/2" Jamb Tube



US01-0425-LLDB 4 1/2" Jamb Tube

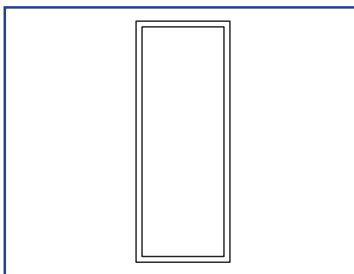

US01-0438-LLCL 4 1/2" Slick Tube



US01-0438-LLDB 4 1/2" Slick Tube

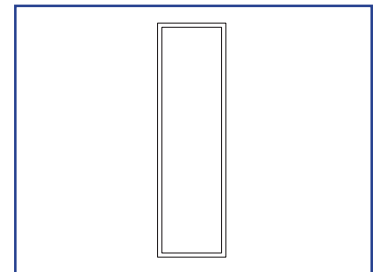

US01-0439-LLCL 6" Slick Tube



US01-0439-LLDB 6" Slick Tube

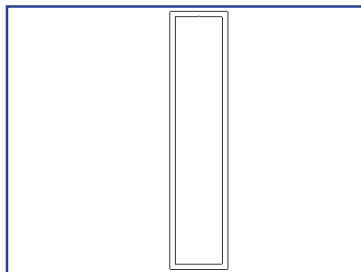

US01-1663-LLCL ICU Jamb, 1"x 4-1/2", CL



US01-1663-LLMF ICU Jamb, 1"x 4-1/2", MF

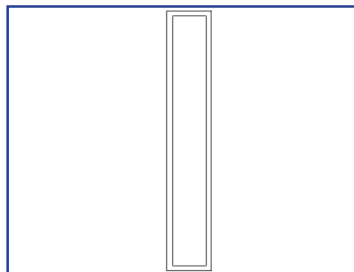

US01-1669-LLCL ICU Jamb, 1"x 6", CL



US01-1669-LLMF ICU Jamb, 1"x 6", MF



FRAMES/TRANSOM

The global leader in door opening solutions

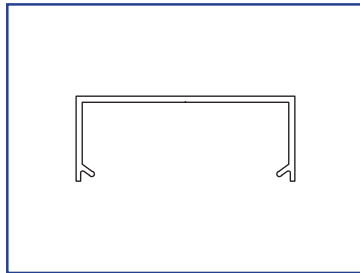

US01-0463-LLCL Jamb, Bi-Way



US01-0463-LLDB Jamb, Bi-Way

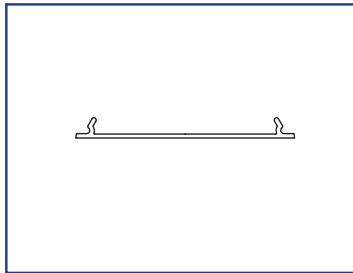

US01-0464-LLCL Cover, Bi-Way



US01-0464-LLDB Cover, Bi-Way

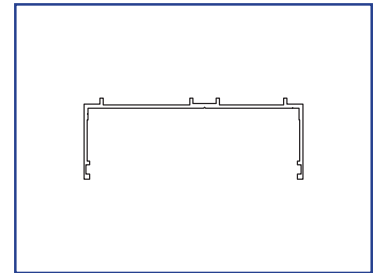

US01-0427-LLCL Header Channel



US01-0427-LLDB Header Channel

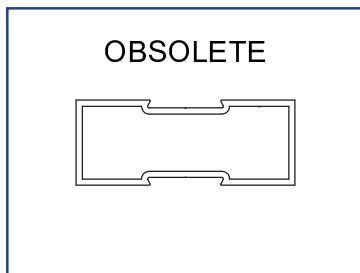

US01-0432-LLCL Double Dovetail Jamb Tube

US01-0432-LLDB Double Dovetail Jamb Tube

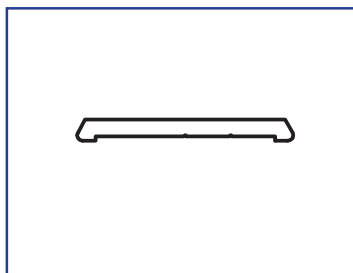

US01-0462-LLCL Double Dovetail Insert



US01-0462-LLDB Double Dovetail Insert

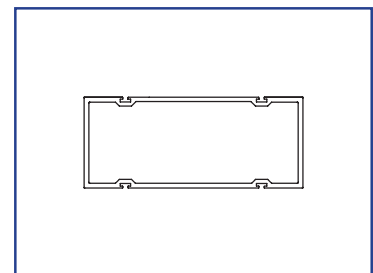

US01-0503-LLCL Cart Door, 4 1/2" Post



US01-0503-LLDB Cart Door, 4 1/2" Post

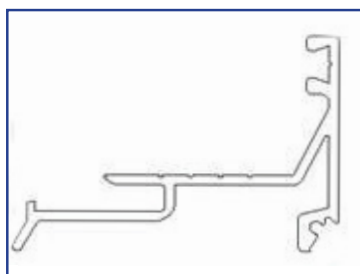

US01-1638-LLCL 1-1/4" Gutter, Clear



US01-1638-LLMF 1-1/4" Gutter, Mill Finish

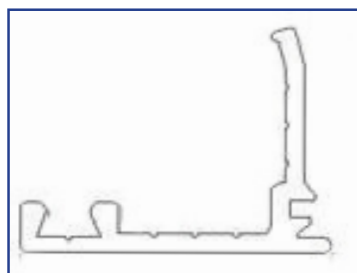

US01-1639-LLCL 1-1/4" Snap, Clear



US01-1639-LLMF 1-1/4" Snap, Mill Finish



Remember - search for all parts online at www.besam-usa.com

© ASSA ABLOY Entrance Systems US Inc.

DOOR VERTICAL RAILS

The global leader in door opening solutions

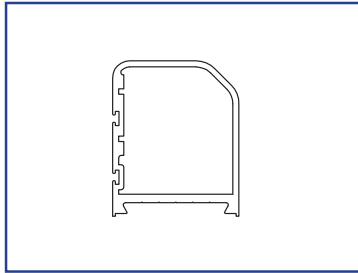

US01-1633-LLCL Narrow Stile Besam Rail, Standard Wall



US01-1633-LLDB Narrow Stile Besam Rail, Standard Wall

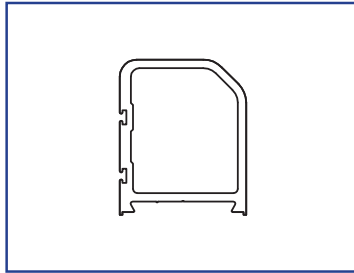

US01-0405-LLCL Narrow Stile Besam Rail, Heavy Wall **



US01-0405-LLDB Narrow Stile Besam Rail, Heavy Wall **

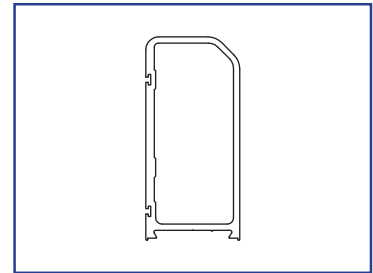

US01-0406-LLCL Medium Stile Besam Rail



US01-0406-LLDB Medium Stile Besam Rail



** Required for Resilience Applications

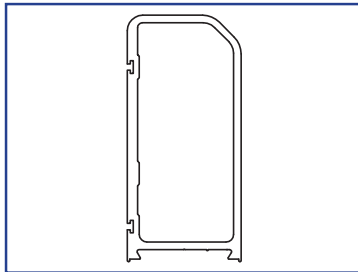

US01-0407-LLCL Wide Stile Besam Rail



US01-0407-LLDB Wide Stile Besam Rail

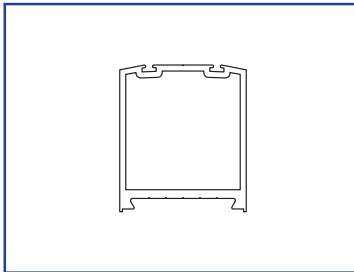

US01-1632-LLCL Narrow Stile Double Fuzz, Nose Rail, Standard Wall



US01-1632-LLDB Narrow Stile Double Fuzz, Nose Rail, Standard Wall

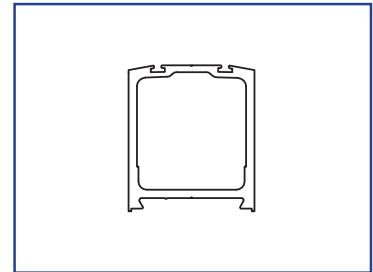

US01-0408-LLCL Narrow Stile Double Fuzz, Nose Rail, Heavy Wall **



US01-0408-LLDB Narrow Stile Double Fuzz, Nose Rail, Heavy Wall **



** Required for Resilience Applications

DOOR VERTICAL RAILS

The global leader in door opening solutions

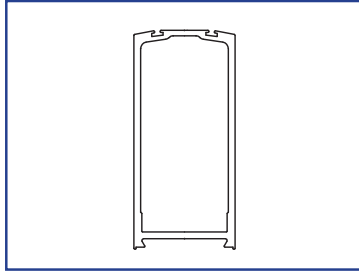

US01-0502-LLCL Medium Stile
Double Fuzz, Nose Rail



US01-0502-LLDB Medium Stile
Double Fuzz, Nose Rail

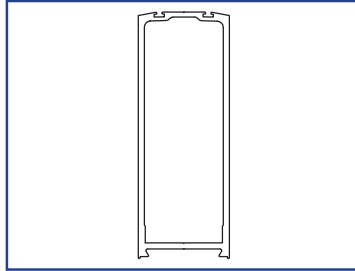

US01-0658-LLCL Wide Stile
Double Fuzz, Nose Rail



US01-0658-LLDB Wide Stile
Double Fuzz, Nose Rail

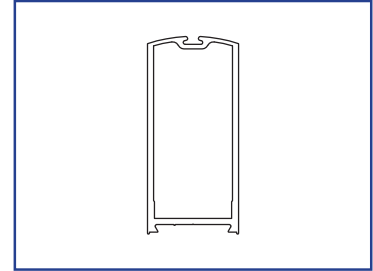

US01-0409-LLCL Medium Stile
Single Fuzz, Nose Rail



US01-0409-LLDB Medium Stile
Single Fuzz, Nose Rail

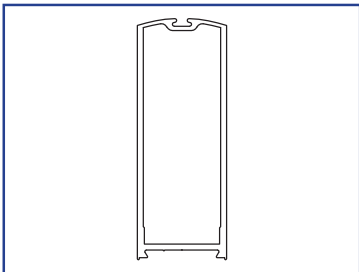

US01-0410-LLCL Wide Style
Single Fuzz, Nose Rail



US01-0410-LLDB Wide Style
Single Fuzz, Nose Rail

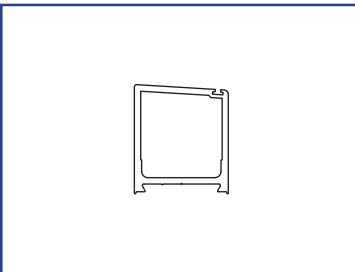

US01-0449-LLCL 2" Hinge Rail



US01-0449-LLDB 2" Hinge Rail

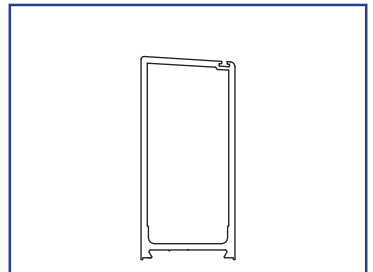

US01-1400-LLCL 4" Hinge Rail



US01-1400-LLDB 4" Hinge Rail



Remember - search for all parts online at www.besam-usa.com

© ASSA ABLOY Entrance Systems US Inc.

DOOR VERTICAL RAILS

The global leader in door opening solutions

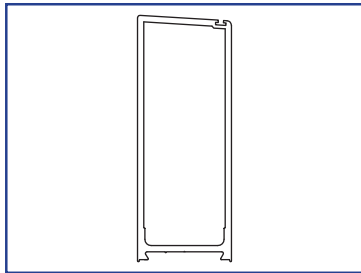

US01-1401-LLCL 5" Hinge Rail



US01-1401-LLDB 5" Hinge Rail

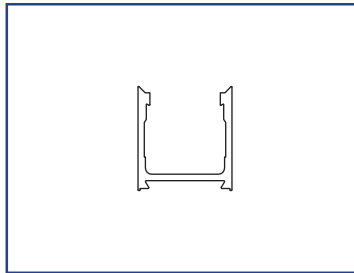

US01-0450-LLCL Open Face Rail



US01-0450-LLDB Open Face Rail

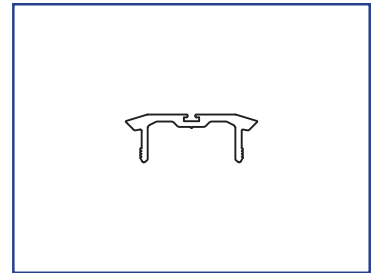

US01-0451-LLCL Open Face Rail, Cover Snap



US01-0451-LLDB Open Face Rail, Cover Snap

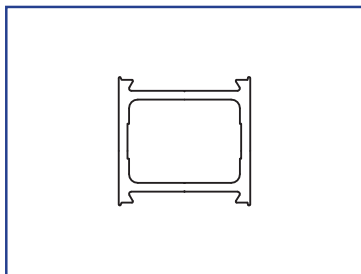

US01-0452-LLCL Vertical Muntin, Ready-Fold



US01-0452-LLDB Vertical Muntin, Ready-Fold

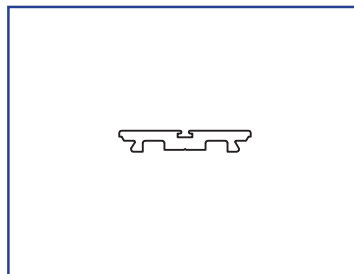

US01-0453-LLBK Filler (Black Only), Ready-Fold



DOOR HORIZONTAL RAILS

The global leader in door opening solutions

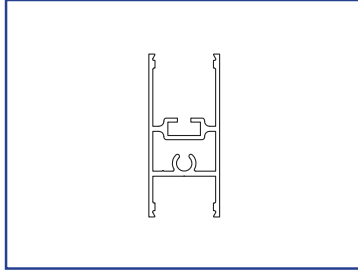

US01-0412-LLCL 4" Bottom Top Rail



US01-0412-LLDB 4" Bottom Top Rail

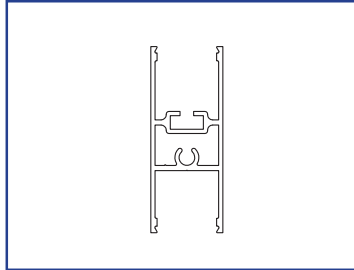

US01-0567-LLCL 4 1/2" Bottom Rail



US01-0567-LLDB 4 1/2" Bottom Rail **OBSOLETE**

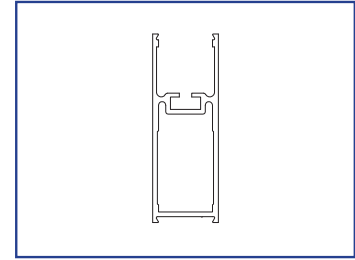

US01-0417-LLCL 5" Bottom Rail



US01-0417-LLDB 5" Bottom Rail

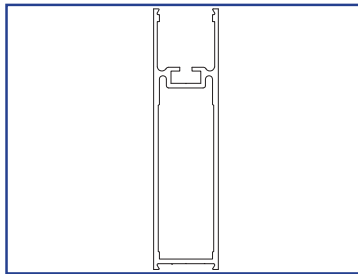

US01-0416-LLCL 7" Bottom Rail



US01-0416-LLDB 7" Bottom Rail

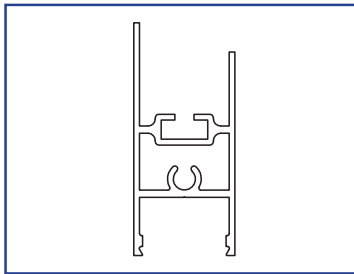

US01-0414-LLCL Active Leaf Bottom Rail, FBO



US01-0414-LLDB Active Leaf Bottom Rail, FBO

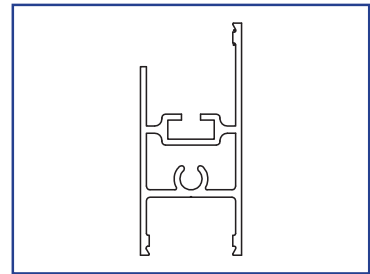

US01-0415-LLCL Side Lite Bottom Rail, FSL



US01-0415-LLDB Side Lite Bottom Rail, FSL



US01-1708-LLCL 10" Bottom Rail, CL



US01-1708-LLDB 10" Bottom Rail, DB



Remember - search for all parts online at www.besam-usa.com

© ASSA ABLOY Entrance Systems US Inc.

DOOR HORIZONTAL RAILS

The global leader in door opening solutions

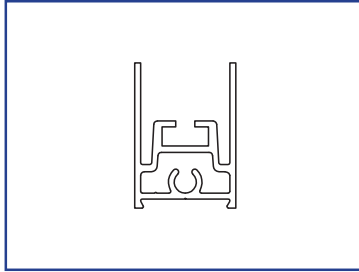

US01-0411-LLCL 2 1/2" Top Rail



US01-0411-LLDB 2 1/2" Top Rail

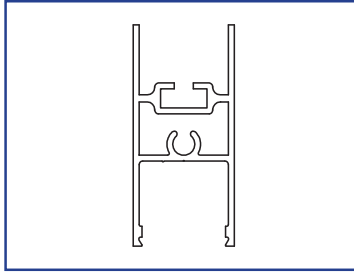

US01-0455-LLCL 2 3/16" Top Rail



US01-0455-LLDB 2 3/16" Top Rail

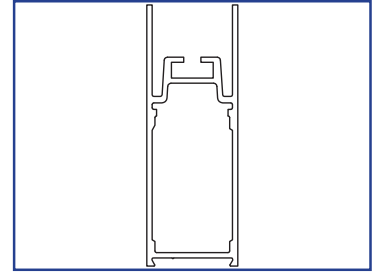

US01-0456-LLCL 5" Top Rail



US01-0456-LLDB 5" Top Rail

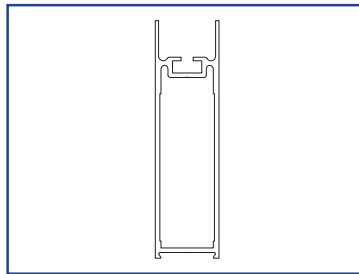

US01-0457-LLCL 6-1/2" Top Rail



US01-0457-LLDB 6-1/2" Top Rail

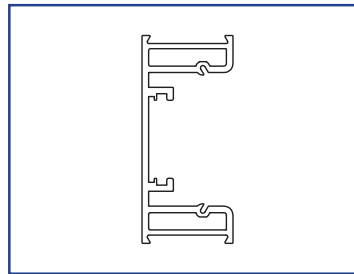

US01-0770-LLCL Flush Panic Muntin



US01-0770-LLDB Flush Panic Muntin

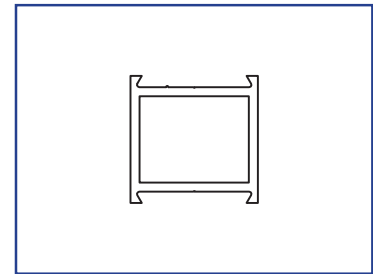

US01-0413-LLCL Horizontal Muntin, 1 3/4"



US01-0413-LLDB Horizontal Muntin, 1 3/4"

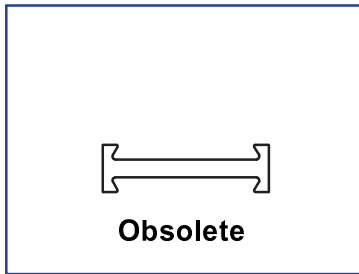

US01-0461-LLCL 1/2" Muntin

US01-0461-LLDB 1/2" Muntin

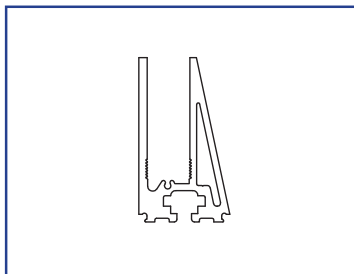

US01-0547-LLCL Shoe, CGL



US01-0547-LLDB Shoe, CGL



DOOR HORIZONTAL RAILS

The global leader in door opening solutions

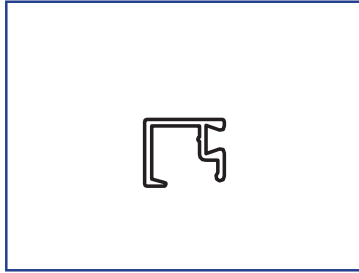

US01-0419-LLCL 1/4" Snap



US01-0419-LLDB 1/4" Snap

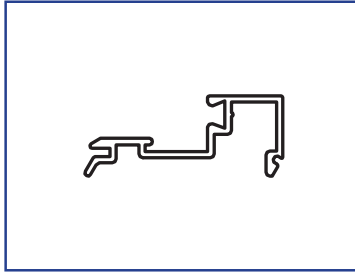

US01-0418-LLCL 1/4" Gutter



US01-0418-LLDB 1/4" Gutter

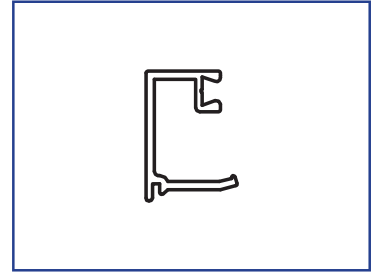

US01-0421-LLCL 5/8" Snap



US01-0421-LLDB 5/8" Snap

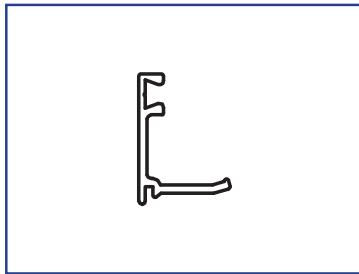

US01-0422-LLCL 1" Snap



US01-0422-LLDB 1" Snap

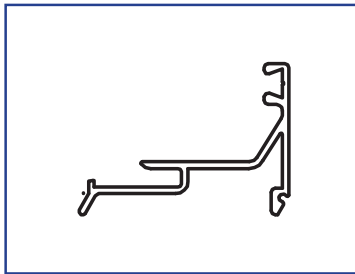

US01-0420-LLCL 5/8" & 1" Gutter



US01-0420-LLDB 5/8" & 1" Gutter



US01-0424-LLCL 1/4" Sloped Snap



US01-0424-LLDB 1/4" Sloped Snap

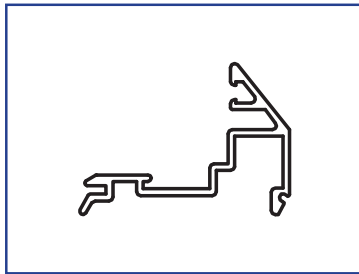

US01-0423-LLCL 1/4" Sloped Gutter



US01-0423-LLDB 1/4" Sloped Gutter

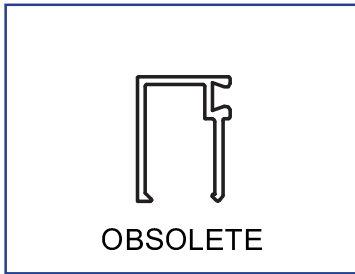

US01-0625-LLCL Non-Impact Snap, Resilience

US01-0625-LLDB Non-Impact Snap, Resilience

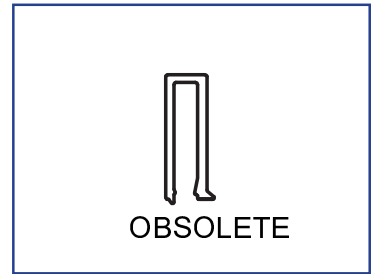

US01-0624-LLCL Full Impact Snap, Resilience

US01-0624-LLDB Full Impact Snap, Resilience

Remember - search for all parts online at www.besam-usa.com

© ASSA ABLOY Entrance Systems US Inc.

DOOR HORIZONTAL RAILS

The global leader in door opening solutions

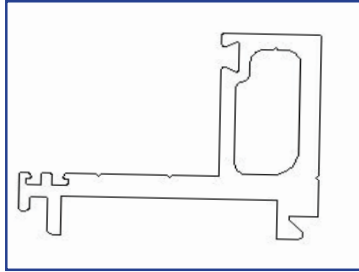

US01-0623-LLCL Gutter, Resilience - *Replaced by US01-1603*

US01-0623-LLDB Gutter, Resilience - *Replaced by US01-1603*

US01-1603-LLCL Gutter, Impact



US01-1603-LLDB Gutter, Impact

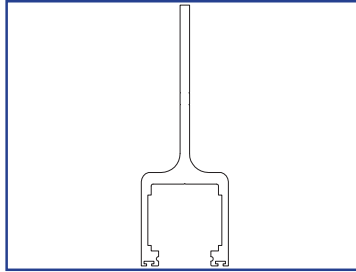

US01-1263-LLCL Plankless Carrier, UniSlide **



US01-1263-LLDB Plankless, Carrier, UniSlide **



**Used with UniSlide PL Standard & PLH Heavy Beams

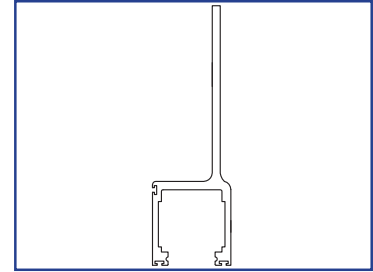

US01-0290-LLCL Standard Carrier, UniSlide **



US01-0290-LLDB Standard Carrier, UniSlide **



**Used with UniSlide Plank & Beam

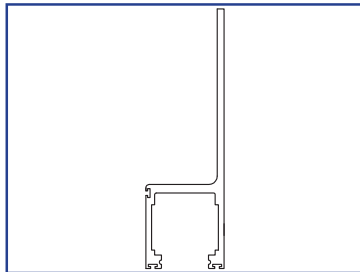

US01-0292-LLCL Carrier, Telescopic UniSlide **



US01-0292-LLDB Carrier, Telescopic UniSlide **



**Used with UniSlide Plank & Beam

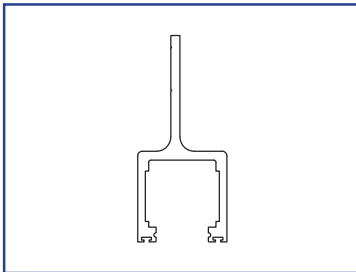

US01-0587-LLCL Carrier, ICU

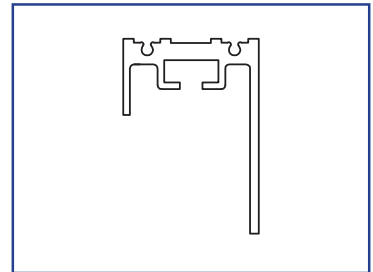

US01-0459-LLCL Carrier, Ready-Fold



US01-0459-LLDB Carrier, Ready-Fold



DOOR HORIZONTAL RAILS

The global leader in door opening solutions

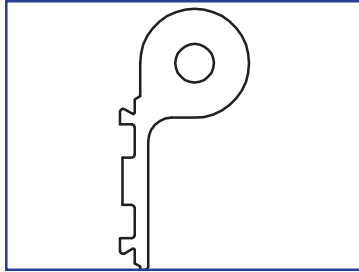

US01-0454-LLBK Hinge, Ready-Fold

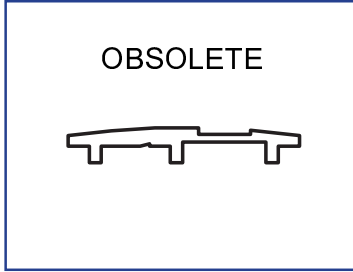

US01-0548-16MF End Cap, CGL

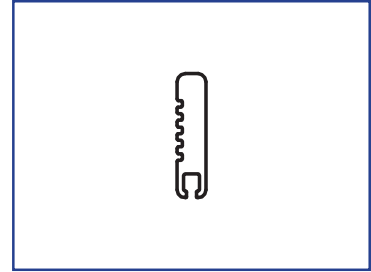

US01-0685-LLDB Brush Holder Concealed Sweep

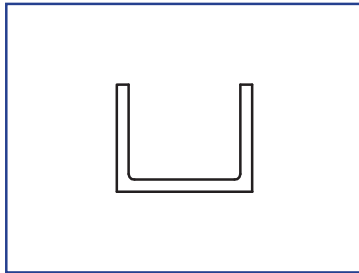

US01-0392-LLMF U Channel
Obsolete- Use 50-01-062

50-01-062 Non-Panic Guide Extension

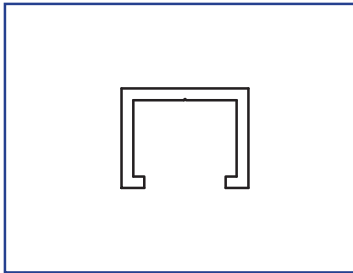

US01-0577-LLMF DHD Guide Track

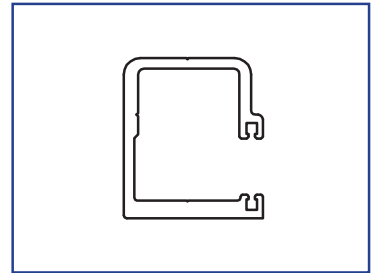

50-01-100 G Channel



50-04-146 G Channel, 42"



50-04-147 G Channel, 48"

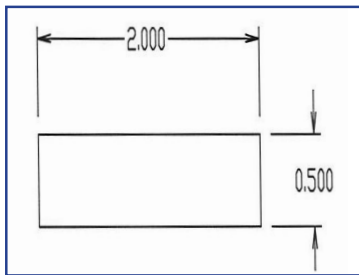

50-01-152 Crash Bar, 1/2" x 2", CL



50-01-153 Crash Bar, 1/2" x 2", DB



Remember - search for all parts online at www.besam-usa.com

© ASSA ABLOY Entrance Systems US Inc.

DOOR HORIZONTAL RAILS

The global leader in door opening solutions

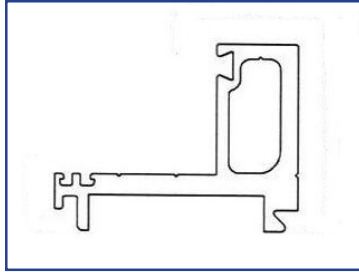

US01-1603-LLCL Impact Gutter, CL



US01-1603-LLDB Impact Gutter, DB



US01-1603-LLMF Impact Gutter, MF

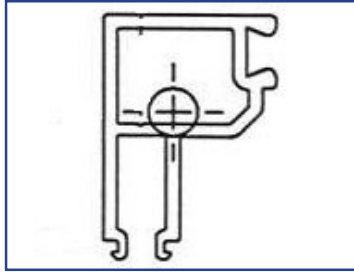

US01-1604-LLCL Non-impact Snap, CL



US01-1604-LLDB Non-impact Snap, DB



US01-1604-LLMF Non-impact Snap, MF

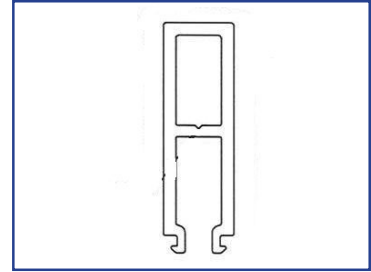

US01-1605-LLCL Impact Snap, CL



US01-1605-LLDB Impact Snap, DB



US01-1605-LLMF Impact Snap, MF

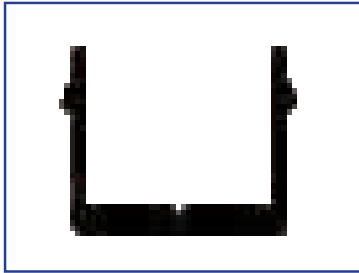

US01-1655-LLMF Shear Plate, MF

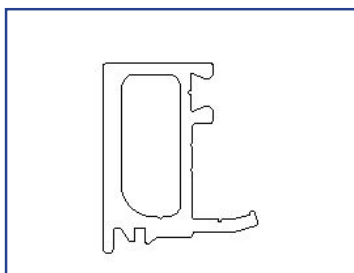

1009672-LLCL 1" Offset Snap CL



1009672-LLDB 1" Offset Snap DB

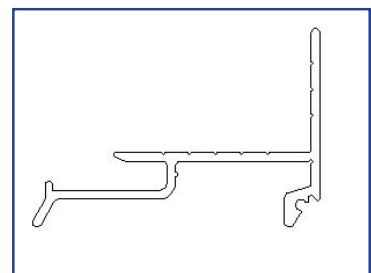

1009673-LLCL 1" Offset Gutter CL



1009673-LLDB 1" Offset Gutter DB



THRESHOLD

The global leader in door opening solutions

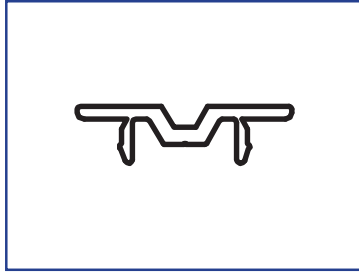

US01-0517-LLMF Filler, Threshold

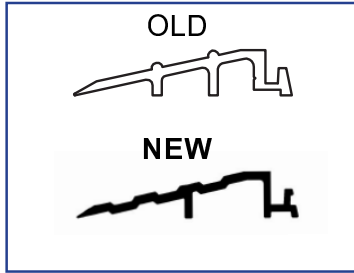

50-01-620 Threshold Lead Up - Replaced by 1013364

1013364 Threshold Lead Up

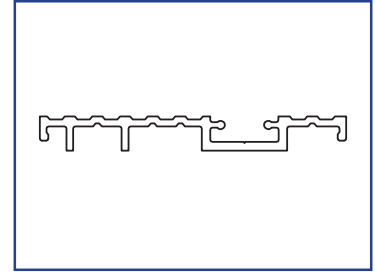

US01-0280-LLMF Threshold, Standard, UniSlide

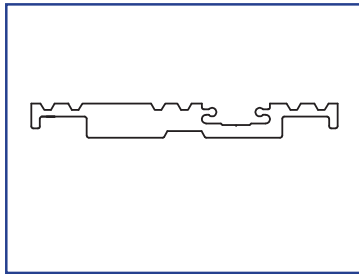

US01-0516-LLMF Threshold, Resilience

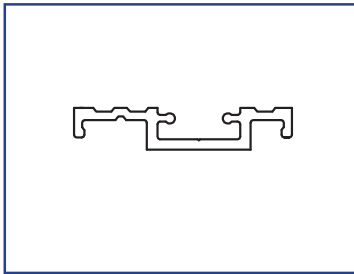

US01-0581-LLMF Threshold, Surface Applied Extension 2 5/8", Telescopic

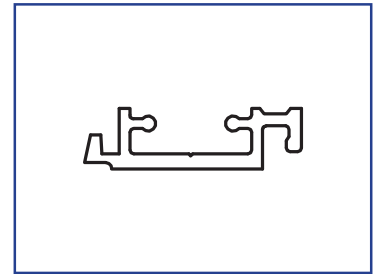

US01-0281-LLMF Threshold, Extension, Telescopic

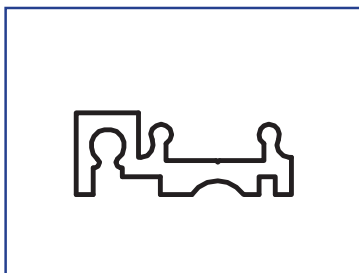

US01-0433-LLBK Track, Pin Guide

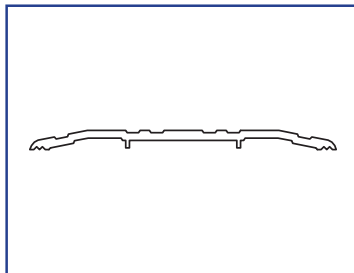

US01-0446-LLMF Threshold, 1/4" x 4"

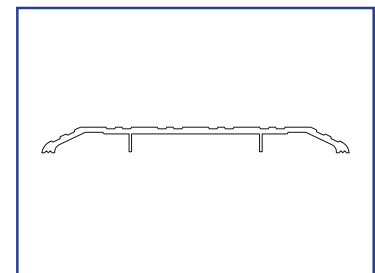

US01-0470-LLMF Threshold, 1/2" x 6"



US01-0448-LLMF Threshold, 1/4" x 6"



Remember - search for all parts online at www.besam-usa.com

© ASSA ABLOY Entrance Systems US Inc.

THRESHOLD



1009330-LLBK Extrusion, Surface Track for T-Block



BESAM SL500

The global leader in door opening solutions

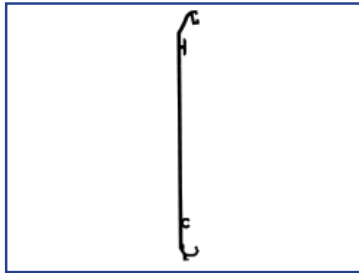

1007366-LLCL 178 Cover, CL



1007366-LLDB 178 Cover, DB

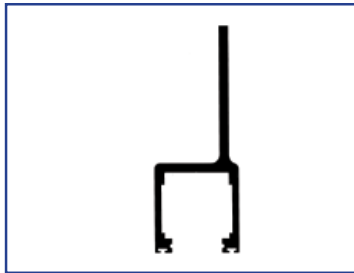

1007361-LLCL 178 Carrier, CL



1007361-LLDB 178 Carrier, DB

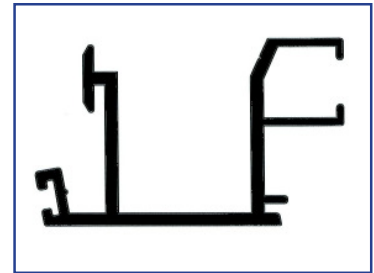

1007363-LLCL Lower Cover Extension, CL



1007363-LLDB Lower Cover Extension, DB

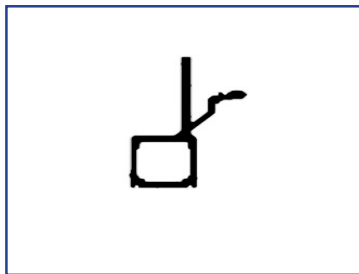

1010272-LLCL Carrier, Telescopic, CL

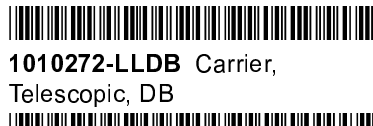

1010272-LLDB Carrier, Telescopic, DB

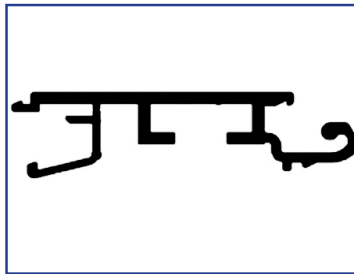

1007370-LLDB Beam Extension, Telescopic, DB

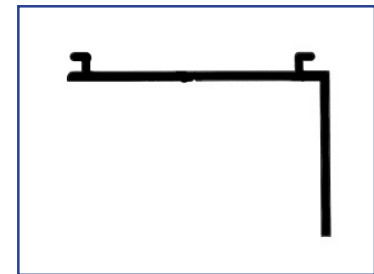

1008138-LLCL Mounting Angle, S/L, CL



1008138-LLDB Mounting Angle, S/L, DB

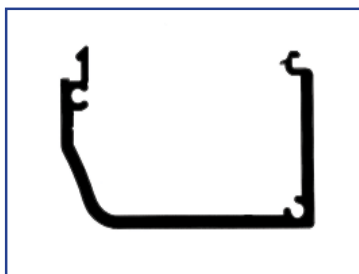

1008139-LLCL Plank Cap, CL



1008139-LLDB Plank Cap, DB

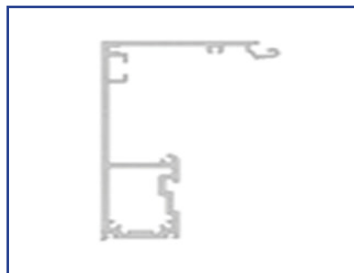

1010590-LLCL Beam/Replaceable Track, CL



1010590-LLDB Beam/Replaceable Track, DB

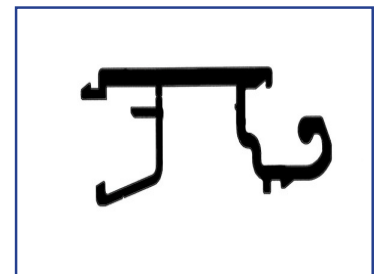

1008779-LLCL 6" Top Ext., CL



1008779-LLDB 6" Top Ext., DB

Remember - search for all parts online at www.besam-usa.com

© ASSA ABLOY Entrance Systems US Inc.

EXTRUSION GUIDE

ASSA ABLOY

BESAM SL500

The global leader in
door opening solutions



1009196-LLCL 4" Slick Tube, CL



1009196-LLDB 4" Slick Tube, CL

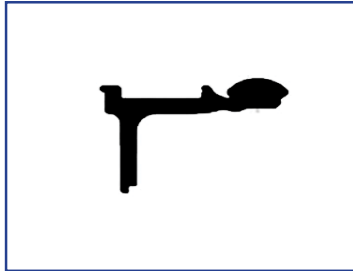

1010591-LLDB Replaceable
Track, DB only



1010787 Double-sided tape for
above track

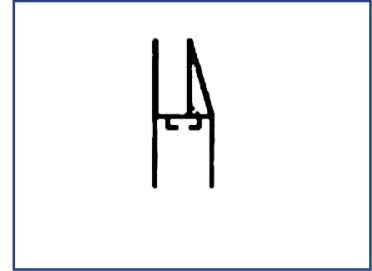

1009993-LLCL CGL 4" Bottom
Shoe, CL



1009993-LLDB CGL 4" Bottom
Shoe, DB

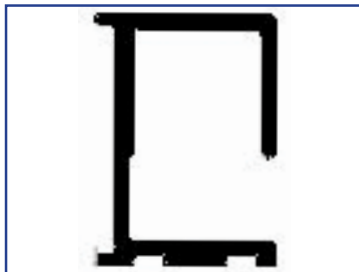

1011153-LLCL P-Panel Roller
Channel, CL



1011153-LLDB P-Panel Roller
Channel, DB



EXTRUSION GUIDE

ASSA ABLOY

BESAM SL500 T67

The global leader in door opening solutions

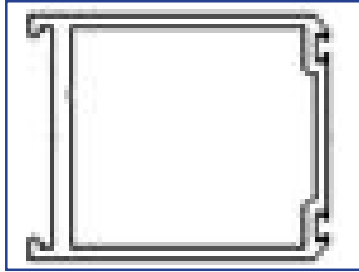

1012935-LLCL Vertical, Narrow Stile Rail, V1N, CL



1012935-LLDB Vertical, Narrow Stile Rail, V1N, DB

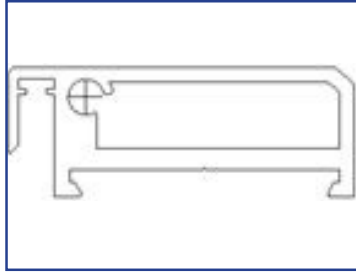

1013476-LLCL Vertical Rail, V2SP, CL



1013476-LLDB Vertical Rail, V2SP, DB

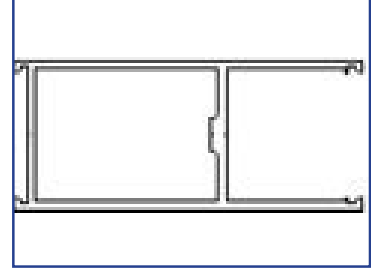

1012942-LLCL 4" Horizontal Rail, H4, CL



1012942-LLDB 4" Horizontal Rail, H4, DB

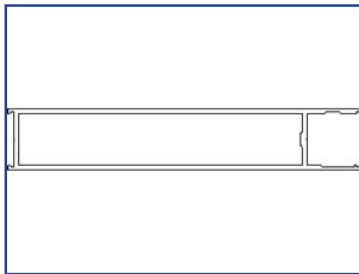

1012946-LLCL 10" Horizontal Rail, H10, CL



1012946-LLDB 10" Horizontal Rail, H10, DB

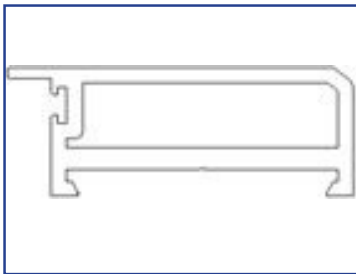

1013890-LLCL Vertical Rail, V3SP, CL



1013890-LLDB Vertical Rail, V3SP, DB

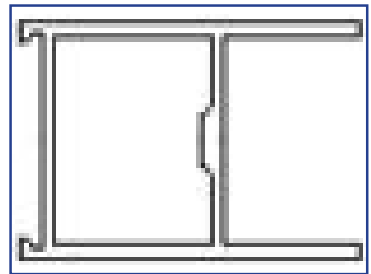

1012941-LLCL 2.5" Horiz. Rail, H2.5, CL



1012941-LLDB 2.5" Horiz. Rail, H2.5, DB

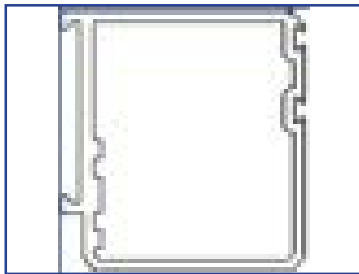

1013884-LLCL Vertical Rail, V1SP, CL



1013884-LLDB Vertical Rail, V1SP, DB



1012950-LLCL .25 X 6.58" Plate, CL



1012950-LLDB .25 X 6.58" Plate, DB

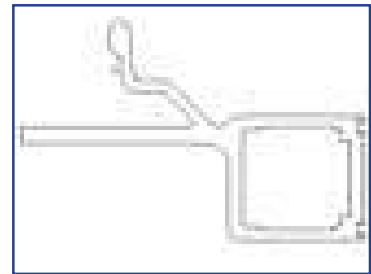

1013938-LLCL Telescopic Carrier, CL



1013938-LLDB Telescopic Carrier, DB



Remember - search for all parts online at www.besam-usa.com

© ASSA ABLOY Entrance Systems US Inc.

EXTRUSION GUIDE

ASSA ABLOY

BESAM SL500 T67

The global leader in
door opening solutions

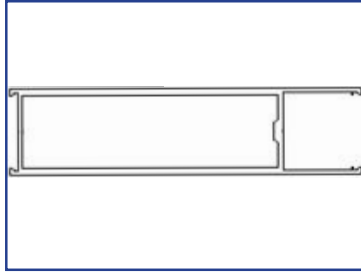

1012945-LLCL 7" Vertical Rail, CL



1012945-LLDB 7" Vertical Rail, DB

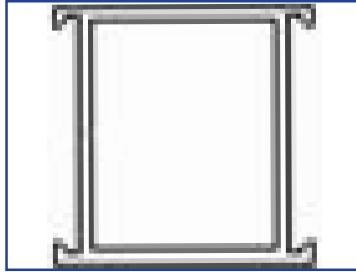

1012947-LLCL Muntin Rail, CL



1012947-LLDB Muntin Rail, DB



TABLE OF CONTENTS

The global leader in
door opening solutions

- Signage
- Pivots and Hinges
- Manual Closers (Surface and Concealed)
- Store Front Accessories
 - Cylinders
 - Thumbturns
 - Lever Handles
 - Lock Indicators
 - Flush Bolts
- Mortise Locks and Accessories
- Exit / Panic Devices
- Electrical Components
- Cross Reference Charts
 - Sweeps
 - Weatherstripping
 - Vinyl
 - Drive Belts (Sliders)
- Ball Catches (including Magnetic)
- Activation & Safety Devices
 - Sensors
 - Safety Devices
 - Modules
 - Push Plates & Related
 - Transmitters & Receivers
 - Harness
 - Accessories

SIGNAGE

The global leader in door opening solutions



75-20-101 Decal, IN



19-24-002 Decal, Yellow, Stand Clear



19-24-001 Decal, Red, Emergency Push to Open



75-20-100 Decal, OUT



21-24-005 Decal, HC Logo, Low Energy



75-20-102 Decal, Caution



21-24-006 Decal, Push to Operate



21-24-007 Decal, Activate Switch to Operate



21-24-008 Decal, Pull to Operate



US24-6305-01 Decal, Header ID



SIGNAGE

The global leader in door opening solutions



55-24-001 Label, Emergency, Folding Door



US15-0138-02 Decal Kit, Low Energy, Swing



US15-0399-02 Decal Kit, Bi-Part



US15-0399-01 Decal Kit, Single, Slider



11-20-203 Label, Besam Logo Cover



US24-0542-01 Label, AAADM Inspection, A156.10



US24-0489-01 Decal, Low Energy, Safety Check



50-24-021 Decal, Sliding Door, Safety Check

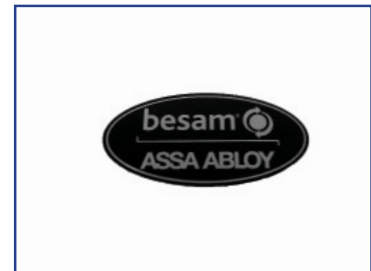

50-24-025 Nameplate, Besam (Oval)



50-24-020 Decal, Swing Door, Safety Check



US24-0201 Decal, Folding Door, Safety Check



Remember - search for all parts online at www.besam-usa.com

© ASSA ABLOY Entrance Systems US Inc.

PIVOTS & HINGES

The global leader in door opening solutions

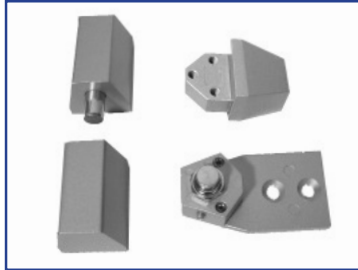

USJ27CL Kit, Pivot, Offset Top and Bottom, CL



USJ27DB Kit, Pivot, Offset Top and Bottom, DB



USJ40LHDB Pivot Kit, Jackson, Offset Top and Bottom, LH, DB



USJ40LHCL Pivot Kit, Jackson, Offset Top and Bottom, LH, CL (Shown)



USJ40RHDB Pivot Kit, Jackson, Offset Top and Bottom, RH, DB



USJ40RHCL Pivot Kit, Jackson, Offset Top and Bottom, RH, CL

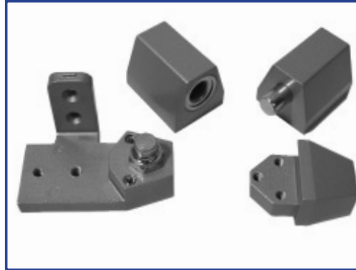

USJ30LHCL Kit, Pivot, Offset Recess 1/8", LH, CL (shown)



USJ30LHDB Kit, Pivot, Offset Recess 1/8", LH, DB



USJ30RHCL Kit, Pivot, Offset Recess 1/8", RH, CL



USJ30RHDB Kit, Pivot, Offset Recess 1/8", RH, DB



US037800 Bottom Pivot Assembly, Kawneer



USJ34LHCL Kit, Pivot, 3/4" Offset Flush, LH, CL (shown)



USJ34LHDB Kit, Pivot, 3/4" Offset Flush, LH, DB



USJ34RHCL Kit, Pivot, 3/4" Offset Flush, RH, CL



USJ34RHDB Kit, Pivot, 3/4" Offset Flush, RH, DB



USUD042 Pivot Kit, Floor Portion, Jackson



PIVOT CROSS REFERENCE:

Besam	USJ27	USJ30	USJ34	USJ40
Jackson	J-27/J28	J-30 / J-31	J-34	J-40
International	2000 Series	3000 Series	4000 Series	6000 Series
Sentinal	812	810	816U	814
CRL	OP-27 / OP-28	OP-30 / OP-31	OP-34	OP-40
Global	N/A	TH1110	TH1114U	TH112

PIVOTS & HINGES

The global leader in
door opening solutions



USJ201060 Bottom Pivot Kit,
Jackson



USNDC100 Pivot Conversion
Kit, Center Hung



50-15-0005 Bottom Pivot Kit,
Swing, NS, Ready Fold



USRX340 Pivot Assembly,
Rixson, Walking Beam

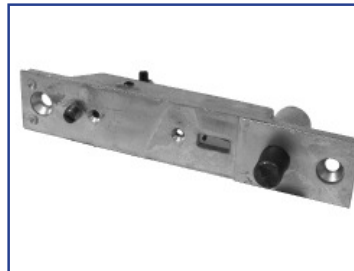

50-05-044 Pivot, Lock Pin,
Retractable, Regular Duty

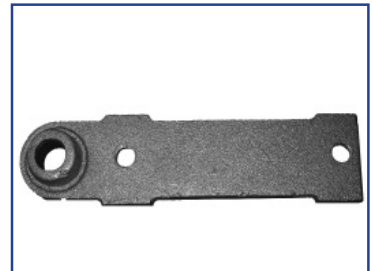

50-05-043 Pivot, Top Door
Portion, Regular Duty



50-04-148 Pivot Block,
Walking Beam



USRX180RH Pivot Kit, Top
Offset, Rixson, RH, CL



USRX180RHBK Pivot Kit, Top
Offset, Rixson, RH, BK



USRX180LH Pivot Kit, Top
Offset, Rixson, LH, CL



USRX180LHBK Pivot Kit, Top
Offset, Rixson, LH, BK



Remember - search for all parts online at www.besam-usa.com

© ASSA ABLOY Entrance Systems US Inc.

PIVOTS & HINGES

The global leader in door opening solutions

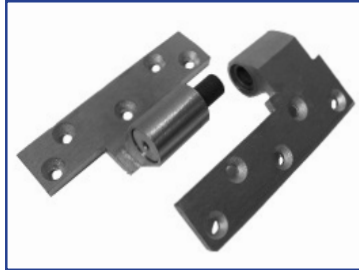

USM19 Pivot, Rixson Intermediate Offset, 3/4", LH, CL



USM19RH Pivot, Rixson Intermediate Offset, 3/4", RH, CL

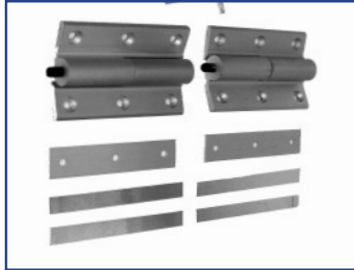

50-15-022CL Hinge Kit, HD, Surface Mount (MAC 10), CL, Bi-Way



50-15-022DB Hinge Kit, HD, Surface Mount (MAC 10), DB, Bi-Way

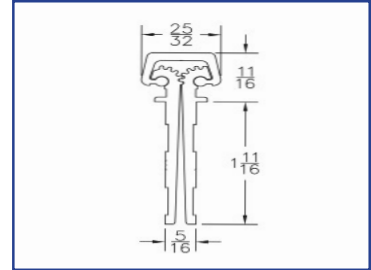

US78011283AL Concealed Leaf Continuous Hinge, 83", CL



US78011283DU Concealed Leaf Continuous Hinge, 83", DB



US78011283HDAL Concealed Leaf, HD, 83", CL



US78011283HDDU Concealed Leaf HD, Continuous Hinge 83" DB



US78011295HDAL Concealed Leaf, HD, Continuous Hinge, 95", CL



US78011295HDDU Concealed Leaf HD, Continuous Hinge, 95", DB



PIVOTS & HINGES

The global leader in
door opening solutions

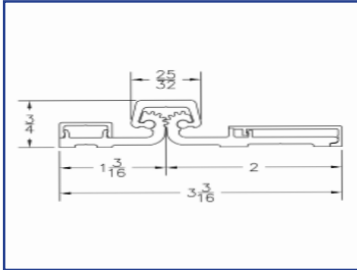

US78015783AL Full Surface
Continuous Hinge, 83", CL



US78015783DU Full Surface
Continuous Hinge, 83", DB



US78015795AL Full Surface
Continuous Hinge, 95", CL



US78015795DU Full Surface
Continuous Hinge, 95", DB



US78015783HDAL Full Surface
HD Continuous Hinge, 83", CL



US78015783HDDU Full Surface
HD Continuous Hinge, 83", DB



US78015795HDCL Full Surface
HD Continuous Hinge, 95", CL



US78015795HDDU Full Surface
HD Continuous Hinge, 95", DB

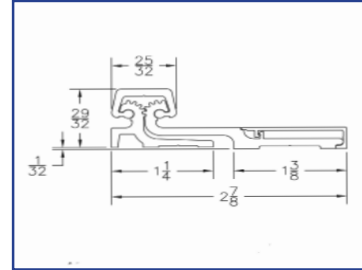

US78021083AL Full Surface
Continuous Swing Hinge, 83", CL



US78021083DU Full Surface
Continuous Swing Hinge, 83", DB



US78021095AL Full Surface
Continuous Swing Hinge, 95", CL



US78021095DU Full Surface
Continuous Swing Hinge, 95", DB



US78021083HDAL Full Surface
Continuous Swing Hinge, 83", CL



US78021083HDDU Full Surface
Continuous Swing Hinge, 83", DB



US78021095HDAL Full Surface
Continuous Swing Hinge, 95", CL



US78021095HDDU Full Surface
Continuous Swing Hinge, 95", DB



Remember - search for all parts online at www.besam-usa.com

© ASSA ABLOY Entrance Systems US Inc.

HARDWARE / CLOSERS

ASSA ABLOY

SURFACE & CONCEALED

The global leader in door opening solutions



50-05-072 Closer, End Load, Light Duty, OHC, 90 deg, HO, Bi-Way
Replaced by 1701868 (Not backwards Compatible)



1701869 Closer, End Load, Light Duty, OHC, 90 deg, NHO, Bi-Way



USJMANCLO Closer, Jackson, OHC, 90 deg, HO

Replaced by USJ20101M20

USJ20101M20



USDRTS88 Closer, Dorma, OHC, 105 NHO, 1/2" Spindle



55-03-025 Door Closer Shaft Extension, OHC, Bi-Way



USGDTC7000ELA Arm Assembly, End Load Center-Hung



USJ20400 Arm, Side Load, OHC



USYA4400HD Closer, Surface, CL, Yale 4400HD



USYA4400HDBZ Closer, Surface, DB, Yale 4400HD



USYA488 Drop Plate, 488 for 4400 Closer



50-05-016 Friction Bar, 32" - 38"



50-05-041 Friction Bar, 38" - 45"



US1601 Closer, Norton, 1600, CL



US1601DB Closer, Norton, 1600, DB



phone: 888-732-3726

parts.na.besam@assaabloy.com

fax: 800-304-9459

© ASSA ABLOY Entrance Systems US Inc.

HARDWARE / CLOSERS

ASSA ABLOY

SURFACE & CONCEALED

The global leader in
door opening solutions

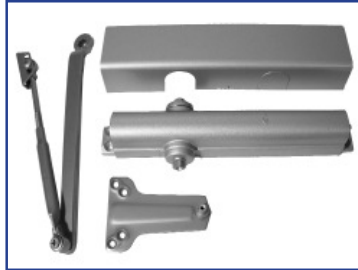

USYA3501 Closer, Surface, CL, Yale 3501

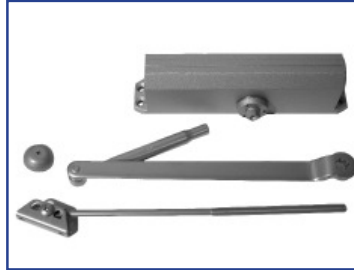

USYATJ51689 Closer, Surface, Top, CL, Yale TJ51

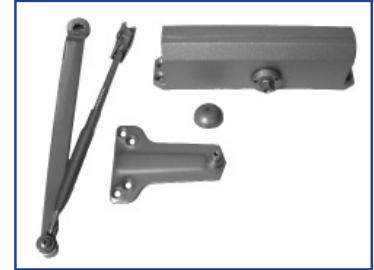

USYA51689 Closer, Surface, CL, Yale 51



USYATJ51690 Closer, Surface, Top, DB, Yale TJ51



USYA51690 Closer, Surface, DB, Yale 51



USJ20101M17 Closer, Adj. Spring, 105 Degree, NHO, OHC



USJ20101M18 Closer, Adj. Spring, 105 Degree, HO, OHC



USJ20101M19 Closer, Adj. Spring, 90 Degree, NHO, OHC



USJ20101M20 Closer, Adj. Spring, 90 Degree, HO, OHC



Remember - search for all parts online at www.besam-usa.com

© ASSA ABLOY Entrance Systems US Inc.

STOREFRONT ACCESSORIES

The global leader in door opening solutions



50-06-198KA Cylinder, Keyed-Alike, Sm Cam (Single), CL



50-06-199KA Cylinder, Keyed-Alike, Sm Cam (Single), BK



50-06-176 Lock, Dummy Cylinder, CL



50-06-177 Lock, Dummy Cylinder, BK



50-06-106 Lock, Thumbturn, CL



50-06-109 Lock, Thumbturn, BK



50-06-104 Lock, Key Cylinder, Sm Cam, CL



50-06-108 Lock, Key Cylinder, Sm Cam, BK



US06-1404-03 Cylinder, Key, Lg Cam (Single), CL -Keyed Alike



US06-1404-04 Cylinder, Key, Lg Cam (Single), BK - **OBSOLETE**



US06-1404-01 Cylinder, Key, Lg Cam, CL - Keyed Different



US06-1404-02 Cylinder, Key, Lg Cam, BK - Keyed Different



50-06-170 Lock, Best Cylinder



50-06-173 Core, Best Lock



50-06-174 B1 Key



50-06-175 CT Key



STOREFRONT ACCESSORIES

The global leader in door opening solutions



US06-0480-01 Cylinder, Medeco



US06-0480-02 Construction Core, Medeco



US06-0480-03 Key, Control, Medeco (Shown)



US06-0491-01 Cylinder, Key, Schlage



US06-0491-02 Construction Core, Schlage



US06-0491-03 Key, Control Schlage



US06-0491-05 Keedex Cylinder Spacer, Schlage, CL



US06-0491-06 Keedex Cylinder Spacer, Schlage, BK



50-06-156 Guard Cylinder, CL



50-06-159 Guard Cylinder, BK

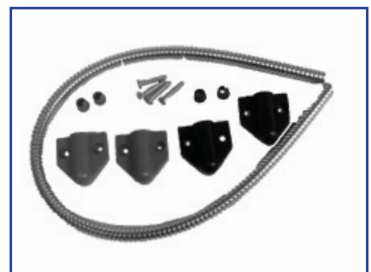

USTSBC Flex Cable, 18" Metal



Remember - search for all parts online at www.besam-usa.com

© ASSA ABLOY Entrance Systems US Inc.

STOREFRONT ACCESSORIES

The global leader in door opening solutions



50-06-178 Escutcheon Cylinder AR8650, CL



50-06-180 Escutcheon Cylinder AR8650, BK



USBB5028 Flush Bolt, Guide



50-06-153 Indicator, Exit, 2-Pt, CL



50-06-154 Indicator, Exit, 2-Pt, DB



50-06-158 Indicator, Exit, 2-Pt, BK



OPEN DOWN



US06-0480-05 Trim Ring, 3/8", CL



US05-0771-01 Dead Bolt Lever AR4550, RH, CL (Shown)



US05-0771-02 Dead Bolt Lever AR4550, RH, BK



US05-0771-03 Dead Bolt Lever AR4550, LH, CL



US05-0771-04 Dead Bolt Lever AR4550, LH, BK



US15-1629-01 Yale Lock Kit, Cyl/ Core/Trim - 6 pin



50-04-137 Flush Bolt Assembly, Bi-Way, CL



50-04-138 Flush Bolt Assembly, Bi-Way, DB



50-06-161 Indicator, Exit, 1-PT, CL



50-06-162 Indicator, Exit, 1-PT, DB



50-06-163 Indicator, Exit, 1-PT, BK



OPEN UP



1702003 Yale 7-Pin Capable Kit, Cyl/Core/Trim



STOREFRONT ACCESSORIES

The global leader in door opening solutions



50-05-018 Pull Handle, 7", CL, ICU/CCU (shown)



50-05-047 Pull Handle, 7", BK, ICU/CCU

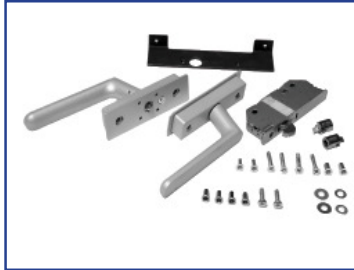

US15-0367-01 Positive Latching Kit, CL, ICU/CCU



US15-0367-02 Positive Latching Kit, BK, ICU/CCU



US05-0367-01 Positive Latch Set, CL, AR4570, ICU/CCU



US05-0367-02 Positive Latch Set, BK, AR4570, ICU/CCU



US05-0367-04 Positive Latching Deadbolt



US08-0661-01 Lock Strike, Positive Latch

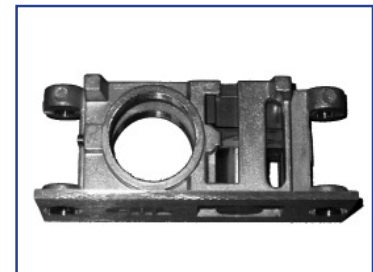

US08-0686-01 Lock Body, Shoe, CGL



50-06-172 Strike, Dust Cover



US15-0909-02 Edge Protector Kit



Includes Stainless Steel Screws (US09-1665-01)

Mounting Hardware:

US09-0686-01 Screw (1 ea)



14-09-003 Tooth (1 ea)



04-09-548474 Nut (1 ea)



Remember - search for all parts online at www.besam-usa.com

© ASSA ABLOY Entrance Systems US Inc.

HARDWARE

MORTISE LOCKS & ACCESSORIES

ASSA ABLOY

The global leader in door opening solutions



50-06-128 Lock Body, Long Bolt Style, w/Hardware



50-06-100 Lock Body, Hook Type Narrow, 1-1/8" Backset



50-06-107 Spacer Tube
For use with 50-06-100



US03-0742-01 Lock Standoff, Medium Style



US03-0742-02 Lock Standoff, Wide Style



50-06-114 Lock Body, Hook Type Medium, 1-1/2" Backset



50-06-116/FB Lock Body, Flush Bolt, 1-1/8", Backset



US03-0727-01 Lock Standoff Impact, Medium Style



US03-0727-02 Lock Standoff Impact, Wide Style



US03-0727-03 Lock Standoff Non-impact, Medium Style



US03-0727-04 Lock Standoff Non-impact, Wide Style

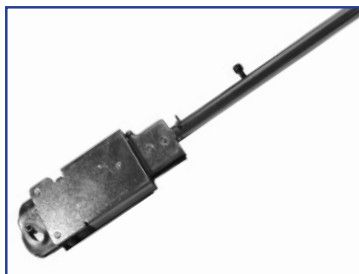

50-06-164 Lock, Header Bolt

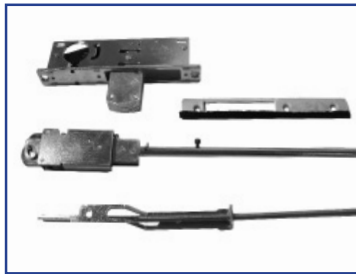

50-15-378 Lock Kit, 3-Pt, CL, 9000



50-15-379 Lock Kit, 3-Pt, DB, 9000



Remember - search for all your parts online at www.besam-usa.com

© ASSA ABLOY Entrance Systems US Inc.

HARDWARE

MORTISE LOCKS & ACCESSORIES

ASSA ABLOY

The global leader in door opening solutions

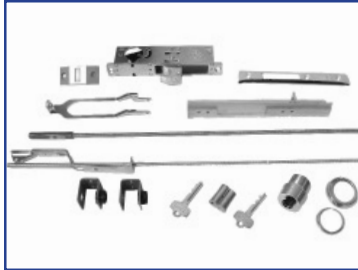

US05-0436-02 3-Pt Lock Assembly, Target, Exterior



50-04-HD3 Guide Block, Lock Rod, HCPK



Mounting Hardware (each):

40-09-201 Screw (need two)



40-09-200 Screw (need one)



50-06-152 Lock, Armored Strike



50-06-110 Lock Rod Converter Assembly, 2-Pt, 45 3/8"

50-06-110/SW Lock Rod Assembly, 2-PT, 35 3/8"

Obsolete- replaced by 50-06-110/OS

50-06-110/OS Lock Rod Assembly, 2-PT, 47 7/8"



1702214 Lock Rod Guide Kit



was 50-06-111



50-06-110/HD Lock Rod Converter Assembly, 3-Pt

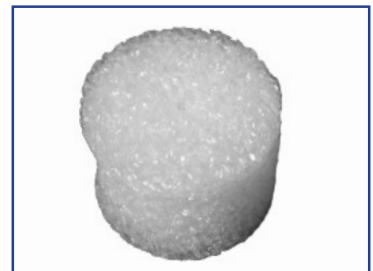

US21-0711-01 Lock Rod Spacer



50-03-141 Armored Strike Slider 2-Pt



50-03-107 Armored Strike, NS, Swing Door



Mounting Hardware (each):

50-09-203 Screw (need four)



HARDWARE

MORTISE LOCKS & ACCESSORIES

ASSA ABLOY

The global leader in door opening solutions



US04-0474-01 Face Plate Strike, Sliding Door, CL



US04-0474-02 Face Plate Strike, Sliding Door, DB (Limited Qtys)



US04-0474-03 Face Plate Strike, Swing Door, CL



US04-0474-04 Face Plate Strike, Swing Door, DB



50-06-102 Faceplate, w/Black Fuzz, CL



50-06-112 Faceplate, w/Black Fuzz, BK



** For use with the 50-06-100 and 50-06-114 Lock Bodies**



50-06-131 Faceplate, w/Black Fuzz, CL



50-06-132 Faceplate, w/Black Fuzz, BK



50-06-131/FB Faceplate, Flush, w/Black Fuzz, CL



50-06-132/FB Faceplate, Flush, w/Black Fuzz, BK



For use with the 50-06-128 Lock Body

Remember - search for all your parts online at www.besam-usa.com

© ASSA ABLOY Entrance Systems US Inc.

EXIT / PANIC DEVICES

The global leader in
door opening solutions



50-05-082 Latch Paddle, LH, BK, AR4591



50-05-083 Latch Paddle, RH, BK, AR4591



50-05-081 Latch Paddle, 2-PT, LH, BK, AR4780



50-05-080 Latch Paddle, 2-PT, RH, BK, AR4780



US08-0649-02 Panic Device, Push Bar, 36", CL



US08-0649-04 Panic Device, Push Bar, 36", BK



US08-0649-03 Panic Device, Push Bar, 48", CL



US08-0649-05 Panic Device, Push Bar, 48", BK



50-05-039 Exit Device, 30", CL



50-05-054 Exit Device, 30", BK



50-05-027 Exit Device, 36", CL



50-05-064 Exit Device, 36", BK



50-05-062 Exit Device, 42", CL



50-05-065 Exit Device, 42", BK



50-05-023 Exit Device 48" CL



50-05-038 Exit Device 48" BK



50-05-025 Exit Device 52" CL



50-05-026 Exit Device 52" BK



50-05-125 Exit Device 58" CL



50-05-126 Exit Device 58" BK



EXIT / PANIC DEVICES

The global leader in
door opening solutions



50-03-335 Pushbar, 35" Door, #4
Stainless



50-03-336 Pushbar, 36" Door, #4
Stainless



50-05-020 Pushbar, 40-1/2" CL



50-05-022 Pushbar, 40-1/2" BK



50-05-035 Pushbar, 34-1/2" CL



50-05-037 Pushbar, 34-1/2" BK



50-05-056 Pushbar, 46-1/2" CL



50-05-057 Pushbar, 46-1/2" BK



ELECTRICAL COMPONENTS

The global leader in door opening solutions



US02-0521-01 Interlock Interface

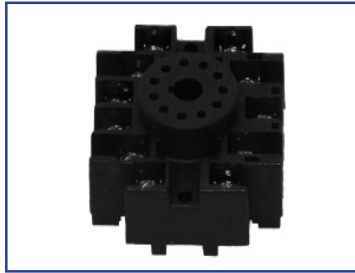

US02-0521-02 Relay Socket, 11 Pin

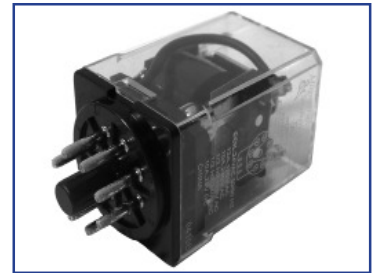

US5X826 Relay, 24VAC, DPDT, 8 Pin



US1A485 Relay, 24VDC, DPDT, 8 Pin

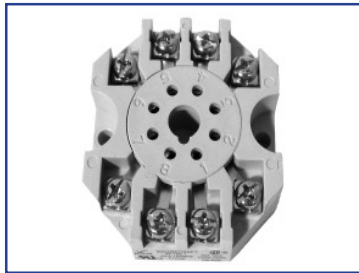

US5X852 Relay Socket, 8 Pin



USIDECRH2B Relay, 24VAC, DPDT, 8 Pin



US5X825 Relay, 12VAC, DPDT, 8 Pin

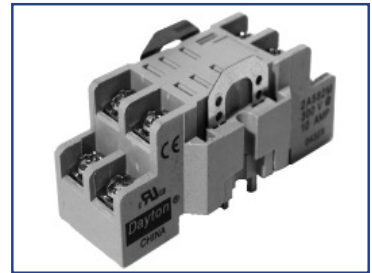

US2A582 Relay, Socket, 8 Pin, Square



USAR4603 Rectifier, Bridge 24VAC / 24VDC



US900253 Relay, Ratchet, 24VDC

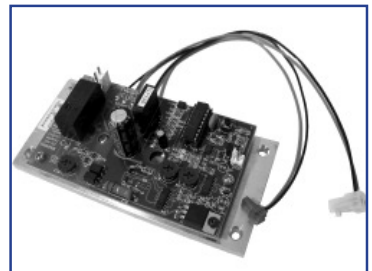

US02-0583-17 Power Close Module, X0130



ELECTRICAL COMPONENTS

The global leader in door opening solutions



US02-0274-12 Transformer, 24VAC, 40 VA, BEA



USS90001 Toggle Switch, On/Off, SPST, UniSlide Cart

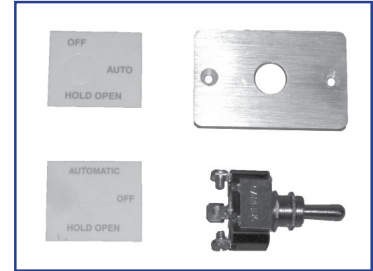

75-15-310 Toggle Switch Kit, 3-position, CL



USCM2200 Key Switch, Narrow Jamb, SS, SPST, NO



US02-1699-06 Jamb Box for CM25/CM250 Switch



75-02-255 Toggle Switch, 3-Position, SPDT, UniSlide Cart



US02-0529-01 Toggle Switch, 3-Position, DPDT, UniSlide Cart



75-15-311 Toggle Switch Kit, 3-Position, DB



USCM1000/60KD Cylinder Mortise, 1-1/8", KD



For use with USCM2200



USDK26SS Keypad, Securitron DK-26 S.S.



H1141 Switch, Magnetic Breakout Slide



US02-0527-01 Sensor, DH400



1009346 Magnetic Barrel Switch (was 70-02-202)



11-02-175 General Security Contact, 12' Leads, NC, CL



Remember - search for all parts online at www.besam-usa.com

ELECTRICAL COMPONENTS

The global leader in door opening solutions



70-02-203 Security Contact Magnet



11-02-176 Magnetic Strip, 3/4", FSL, By the Foot

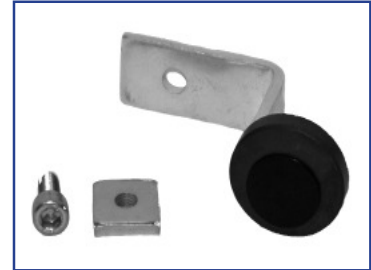

US05-0305-01 Ring Magnet Assembly, FBO, UniSlide



30-02-200 Short Arm Microswitch, SM900



USV3L131D8 Long Arm Microswitch, No Roller



USMAGLOCK1 Lock, Switch, Magnetic, BEA, 1200lbs



US02-0583-06 Long Arm Microswitch, SM900



USBMAGLOCK3 Lock, Single, Magnetic, BEA, 12/24VDC



USM32F-24 Lock, Securitron Magna Lock



US02-0721-01 Electric Bolt, Fail Safe, Ready Fold



ELECTRICAL COMPONENTS

The global leader in
door opening solutions



US15-1682-01 Cycle Counter
Kit

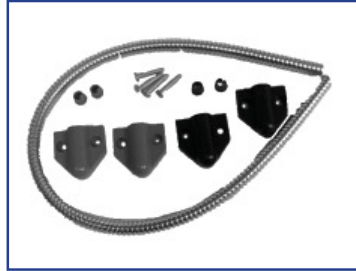

UST5BC Door Loop,
Armoured, 18"



Remember - search for all parts online at www.besam-usa.com

© ASSA ABLOY Entrance Systems US Inc.

4 Rev B

CROSS REFERENCE CHARTS

The global leader in
door opening solutions

Slider Drive Belts		UniSlide	Besam SL500	UniSlide Telescopic	Besam SL500 Telescopic	CGL	ICU Telescopic	AMD 1 & 2	PG 4000	PG 3000	Horton	Horton Telescopic	Stanley	Stanley Telescopic	Dor-O Matic	Dorma	Gildor	Nabco/Gyro Tech	Recon/KM	Sierra/BWN	Tormax
P/N	Description																				
1701406	Belt, MLN 10 GW8M		x																		
735351	Belt, Wide, 9/16" width, Unislide	x		x		x		x													x
1008453	Cable, Pulley, 3/64"				x																
1000062	Belt, Narrow, 1/4" width, UniSlide, Telescopic			x		x															
**85101	Belt, SDW,85101 *Special Order*																			x	
** 130-004	Belt, 15m x8m * Special Order*																x				
18-20-004	Belt ,L8MX, 9/16" width								x						x	x					
H2658	Belt, Wide, 1" width, Black,Horton,2001, 2003										x										
H5639	Belt, 3/4" width, Horton 2150											x									
N9999990008	Belt, 3/8" width, KM 1100 Slider																		x		
USLH100US	Use H2658										x										
USLO75	Belt, LO75, 3/4" width									x			x								x
USLO75N	Belt, LO75, 3/8" width, Stanley, Telescopic													x							

Vinyl, Glass		Resilience	Unislide	CGL	Besam SL500 CGL	ICU	AMD 1 & 2	PG 4000	PG 3000	Horton	Stanley	Boon Edam	Dor-O Matic	Dorma
P/N	Description													
S706812	Glazing, bead black glass stop											x		
G142314	Gyrotech Glass Stop													
H397	Vinyl Adaptor									x				
53-20-002	Vinyl Roll in Glazing		x				x							
US20-0939-01	Vinyl, Glassbead, 1/4", 1" glass, Flush Glaze		x	x		x								
US20-0940-01	Vinyl, Glassbead, 5/8" glass, Flush Glaze		x	x		x								
US20-0213-01	Vinyl, Glassbead, 1/4" Glass	x	x			x	x	x	x					
1009665	Vinyl, Weather Seal CGL				x									
50-20-106	Vinyl, Glassbead, 3/8", 3/4" glass		x			x	x	x	x					
50-20-102	Vinyl, Glassbead , 5/8", 1" glass		x			x	x	x	x					
53-20-001	Vinyl, Pull-in Glazing													
50-20-225	Vinyl, Sloped 1/4" glass		x			x	x							
S412199	Vinyl, Pile AL 2000											x		

CROSS REFERENCE CHARTS

The global leader in door opening solutions

Weather Stripping		Resilience	UniSlide	Besam SL500	Besam SL500 CGL	CGL	ICU	AMD 1 & 2	PG 4000	PG3000	Swingmaster Passport	Horton	Stanley	Boon Edam	Dor-O-Matic	Dorma	Glider	Nabco/Gyro Tech	Recoor/Km	Sierra/B/W/N	Tornax
P/N	Description																				
85-20-021	Felt CGL w/strip, BLK					x															
USCRL11335A	Felt Pile, 3/16" back, 1/4" Grey pile						x														
S712044	Felt pile, Magicswing, 7/16" back, 3/8" BLK Pile												x								
85-20-012	Felt Pile, self adhesive, BLK, 1/4"back,---pile					x															
US20-0905-01	Felt Pile, Tall, 3/16" back, 7/16" BLK pile		x	x																	
50-20-6403	Felt Pile, Vertical, ms, 6/16" back w/ 6/16" BLK pile								x	x											
50-20-6402	Felt Pile, vertical, ns, 3/16" back w/ 5/16" BLK pile		x	x			x	x													
S411624	Felt Pile, self adhesive, 1/4" back, 5/16" BRN pile												x								
85-20-032	Felt w/strip, CGL, 1.00", BLK felt					x															
85-20-022	Felt w/strip, CGL, 1.250 BLK felt					x															
50-20-HD187DB	Finn, Pile, Vertical, NS		x	x				x													
50-20-126	Insert, semi-rigid, PVC, MS, BLK, Sliders, Older Passport		x						x	x	x										
50-20-123	Insert, semi-rigid, PVC, NS, BLK, sliders, New Passport		x				x	x	x	x	x										
HC02930	Mohair Head weatherstrip												x								
H03891	Mohair, vertical interlock, 3/8" x 3/8" , Horton 2000,2001,2003												x								
H350	Mohair, Nosing, Horton 2000,2001,2003												x								
50-20-210	Seal, non-shedding, ICU, 3/8 x .19, Clean Room						x														
85-01-030	Vinyl, weather strip, CGL					x															
S411796	Vinyl, wearstrip, Duraglide												x								
S711704	Vinyl, weatherstrip, ICU												x								
S706812	Glass Stop, Glazing, Bead, Vinyl, Black												x								
H3411	Weatherstrip, clean room												x								
1009663	Glass Seal Clip, 1/2" - 3/8" - 10 ft. lengths					x															
1009664	Seal, End Clip, 1/2" - 3/8" - 10 ft lengths					x															
1009665	Weather Seal, 'T' shaped					x															
700826	Vinyl, Fingerguard, Balanced Door Application																				

For Ready-Fold:

Nose rail: Weather-stripping #50-20-6402 rubber filler # 50-20-123.

Back rail: Weather-stripping # 50-20-6402.

Top track: (mounted on bottom of header) weather-stripping # 50-20-6402

CROSS REFERENCE CHARTS

ASSA ABLOY

The global leader in door opening solutions

Sweeps		Resilience	UniSlide	CGI	ICU	AMD 1 & 2	PG 4000	PG3000	Swingmaster Passport	Horton	Stanley	Boon Edam	Dor-O-Matic	Dorma	Gildor	Nabco/Gyro Tech	Kawneer	Record/Km	Sierra/BVN	Tormax
P/N	Description																			
50-15-170	Sweep, SA, DB, 36" Long, 1/2" BLK Brush								x											
50-15-160	Sweep, SA, CL, 36" Long, 1/2" CL Brush								x											
US08-1406-01	Sweep, SA, CL, 36" Long, 1 3/4" CL Brush, Food Lion	x																		
US08-1406-02	Sweep, SA, DB, 36" Long, 1 3/4" BLK Brush, Food Lion	x																		
US15-0659-01	Sweep, SA, CL, 48" Long, Rubber Sweep	x																		
US15-0659-02	Sweep, SA, CL, 48" Long, Rubber Sweep	x																		
USNG600A	Sweep, SA, CL, 48" Long, 1/2" CL Brush																			
USNG600DBK	Sweep, SA, DB, 48" Long, 1/2" CL Brush																			
USP18100CNB48	Sweep, SA, CL, 48" Long, 1" BLK Brush																			
USP18100DNB48	Sweep, SA, DB, 48" Long, 1" BLK Brush																			
50-15-162	Sweep, SA, CL, 48" Long, 1/2" BLK Brush								x											
50-15-172	Sweep, SA, DB, 48" Long, 1/2" BLK Brush								x											
US08-0659-01	Sweep, SA, CL, 48" Long, CL rubber, Hurricane	x																		
US08-0659-02	Sweep, SA, DB, 48" Long, DB rubber, Hurricane	x																		
US08-0785-01	Sweep, SA, CL, 60" Long, 3/8" CL Brush				x															
US08-0785-02	Sweep, SA, DB, 60" Long, 3/8" BLK Brush				x															
US08-0986-01	Sweep, SA, CL, 96" Long, 1/2" CL Brush, Cart Door	x																		
US05-0685-05	Sweep, Assy, Concealed Slider, 1" BLK Brush	x	x	x	x	x	x													
50-20-215	Brush only, 1" BLK Brush, used on concealed sweep	x	x	x	x	x	x													
US04-0685-01	Sweep housing only, used on concealed sweep	x	x	x	x	x	x													

BALL CATCH ASSEMBLIES

UniSlide / ICU Active Leaf

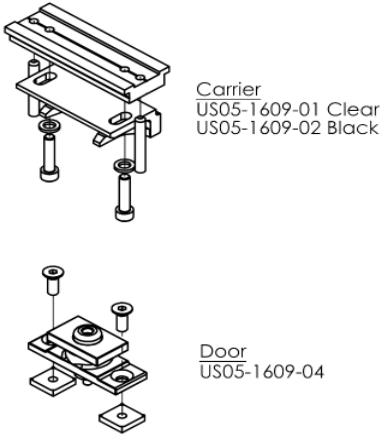

UniSlide Sidelite

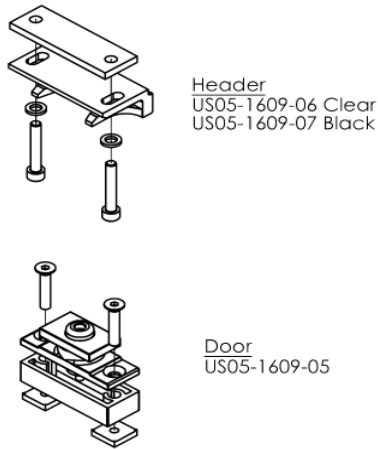

Tele. UniSlide / ICU Active Leaf #2

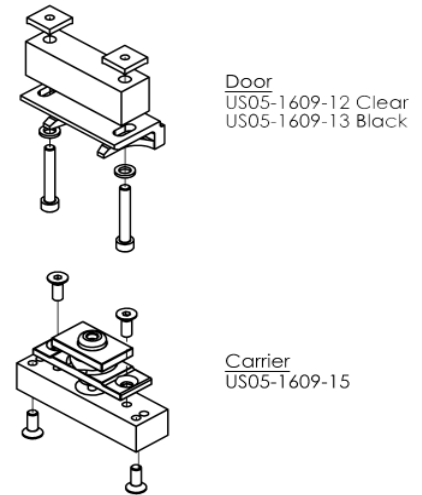

UniSlide Pocket Package/ SA w/ Sidelites

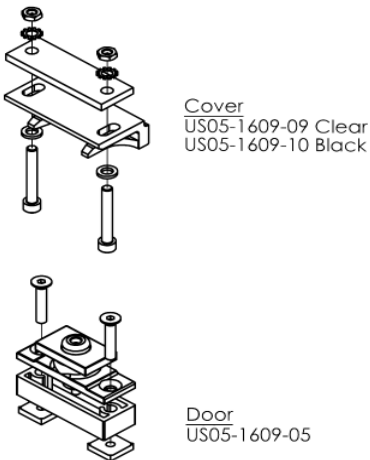

Ready-Fold

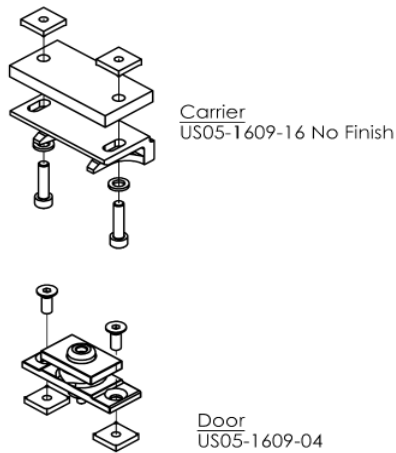

ICU Sidelite

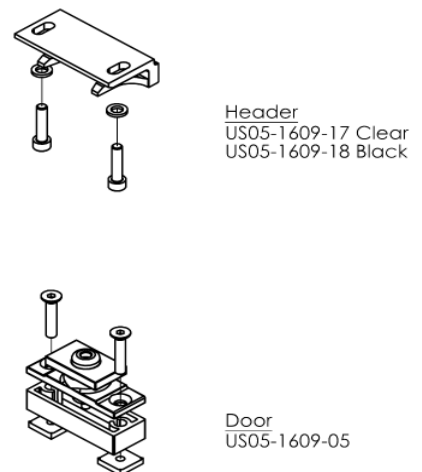

****FOR BARCODES SEE NEXT PAGE****

Remember - search for all parts online at www.besam-usa.com

BALL CATCH ASSEMBLIES

ASSA ABLOY

The global leader in
door opening solutions

BALL CATCH ASSEMBLY BARCODES

UniSlide / ICU Active Leaf

Carrier

US05-1609-01 

US05-1609-02 

Door

US05-1609-04 

UniSlide Sidelite

Header

US05-1609-06 

US05-1609-07 

Door

US05-1609-05 

UniSlide Telescopic / ICU Active Leaf #2

Door

US05-1609-12 

US05-1609-13 

Carrier

US05-1609-15 

UniSlide Pocket Package / SA w/Sidelites

Cover

US05-1609-09 

US05-1609-10 

Door

US05-1609-05 

Ready-Fold

Carrier

US05-1609-16 

Door

US05-1609-04 

ICU Sidelite

Header

US05-1609-17 

US05-1609-18 

Door

US05-1609-05 

MAGNETIC CATCH ASSEMBLIES

SL500/Unislide/
VersaMax Active Leaf

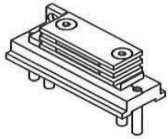

Carrier
US05-1719-01

Cover Plate (Required with above Kit)
US04-1719-01 Clear
US04-1719-02 Black
US04-1719-03 Mill

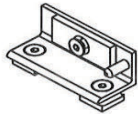
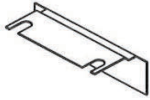

Door
US05-1719-04

SL500/Unislide Sidelite

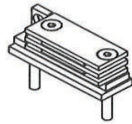

Header
US05-1719-06

Cover Plate (Required with above Kit)
US04-1719-01 Clear
US04-1719-02 Black
US04-1719-03 Mill

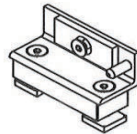
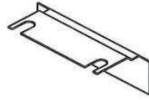

Door
US05-1719-05

Tele. Unislide/
VersaMax Active Leaf #2

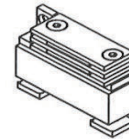

Door
US05-1719-12

Cover Plate (Required with above Kit)
US04-1719-11 Clear
US04-1719-12 Black
US04-1719-13 Mill

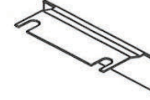

Note:
This cover plate specifically
for Active Leaf #2
magnetic latch!

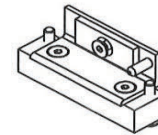

Carrier
US05-1719-15

SL500/Unislide Pocket
Package/ SA w/Sidelites

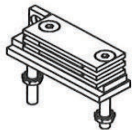

Cover
US05-1719-09

Cover Plate (Required with above Kit)
US04-1719-01 Clear
US04-1719-02 Black
US04-1719-03 Mill

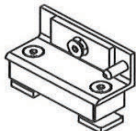
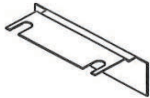

Door
US05-1719-05

SW200i-Fold/Readyfold

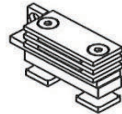

Carrier
US05-1719-16

No Cover Plate required with above Kit)

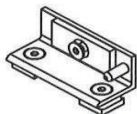

Door
US05-1719-04

VersaMax Sidelite

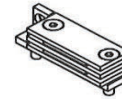

Header
US05-1719-17

Cover Plate (Required with above Kit)
US04-1719-01 Clear
US04-1719-02 Black
US04-1719-03 Mill

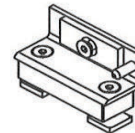
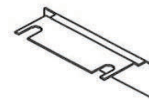

Door
US05-1719-05

****FOR BARCODES SEE NEXT PAGE****

Remember - search for all parts online at www.besam-usa.com

MAGNETIC CATCH ASSEMBLIES

ASSA ABLOY

The global leader in
door opening solutions

MAGNETIC CATCH ASSEMBLY BARCODES

Unislide/VersaMax Active Leaf

Carrier

US05-1719-01



Door

US05-1719-04



Unislide Sidelite

Header

US05-1719-06



Door

US05-1719-05



Unislide Pocket Package/ SA w/Sidelites

Cover

US05-1719-09



Door

US05-1719-05



VersaMax Sidelite

Header

US05-1719-17



Door

US05-1719-05



Cover Plate (Required with above kits)

US04-1719-01 Clear



US04-1719-02 Black



US04-1719-03 Mill



Readyfold (No Cover Plate Req'd)

Carrier

US05-1719-16



Door

US05-1719-04



Telescopic Unislide/Versamax Active Leaf #2

Door

US05-1719-12



Carrier

US05-1719-15



Cover Plate specifically for Active Leaf #2

US04-1719-11 Clear



US04-1719-12 Black



US04-1719-13 Mill



Besam SL500 Sidelite

Header

US05-1719-18



Door

US05-1719-05



Besam SL500 Telescopic

Carrier

1010092



Door

1010094



**HARDWARE
ACTIVATION & SAFETY DEVICES**

ASSA ABLOY

The global leader in
door opening solutions

SENSORS



US02-0300-01 Sensor, w/Besam Logo, Wizard G3 - **replaced by 1702642**

US02-0300-02 Sensor, Wizard G3, Without Logo (Shown) - **replaced by 1702688**



US02-1676-01 Sensor, w/Svc #, 10WIZARDIIBFS, BEA - **replaced by 1702642**

US21-1676-01 Cover, Wizard w/Logo/Svc # - **Discontinued**

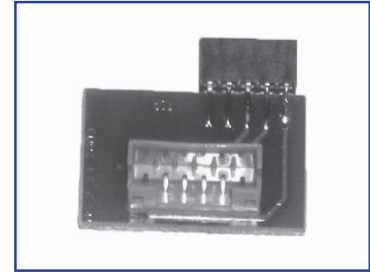

USBIFWIZARD Sensor Interface, Wizard, BEA



USWBWA Sensor Mount, Ceiling, Wizard



USB700197 Sensor Cover, Wizard, No Lenses



1702641 SC53-M w/ logo & PNP Harness, IXIO



1702679 SC53-M No Logo w/ PNP Harness, IXIO (shown)



1702642 SC53-M w/ logo & HW Harness, IXIO



1702688 SC53-M No logo & HW Harness, IXIO



1702685 Cover only w/ logo, IXIO



1702686 Cover only w/o logo, IXIO



1702744 Cover, Silver, IXIO



1702745 Cover, White, IXIO



1702746 Cover, Rain, IXIO

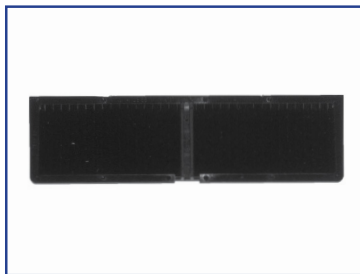

US02-0640-07 Wizard Lens, Wide, UltraView



US02-0640-08 Wizard Lens, Narrow, UltraView



USBWRC Wizard Rain Cover, Replaced by **US02-0274-05** below



US02-0274-05 Weatherhood, Universal Rain Cover, BEA



phone: 888-732-3726

parts.na.besam@assaabloy.com

fax: 800-304-9459

© ASSA ABLOY Entrance Systems US Inc.

**HARDWARE
ACTIVATION & SAFETY DEVICES**

ASSA ABLOY

The global leader in
door opening solutions

SENSORS



US02-1675-01 Sensor, SC32-M
Logo Only - **being replaced by
1702463**

US21-1675-01 Sensor, Cover,
SC32-M, Black, Logo - **being
replaced by 1702683**



US02-1677-01 Sensor, SC32-M
Logo/Svc # - **being replaced by
1702668**

US21-1675-02 Sensor Cover,
SC32-M, Logo, Svc #, BK -
Discontinued



US02-1699-01 Sensor, OA
Presence, Optex

US02-1699-07 Sensor, OA
Presence II, Optex



US15-0640-14 Sensor Single
Kit, UltraView

US21-0640-06 Cover, UltraView



US15-0640-10 Sensor Dual
Kit Complete, UltraView

Obsolete



1702463 Sensor, SC31-M w/ logo
& HW harness (Shown)

1702668 Sensor, SC31-M w/o
Logo w/ PNP harness

1702471 Sensor, SC31-M Logo &
PNP harness

1702687 Sensor, SC31-M No Logo
& HW harness

1702683 Cover only w/ logo

1702684 Cover only w/o logo

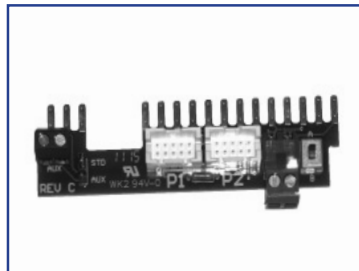

US02-0640-02 Interface Board,
Blue, Rev C, UltraView

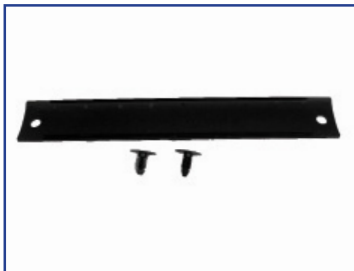

US15-1718-01 Ultraview Cover
Kit

Remember - search for all parts online at www.besam-usa.com

© ASSA ABLOY Entrance Systems US Inc.

SENSORS



1701736 Besam SP33-OP,
 Adaptable DMPS



1701732 Besam SP34-OP,
 FrameMounted, OPS



1702074 Besam SP34-OP,
 FrameMounted, OPS, w/ PNP



1702067 Besam SP35,
 SP35MB, Sensor Head



1701732 Sensor Kit, Swing Complete, Optex (was USPROSWING-PRECOM)



US02-0527-01 Sensor, MS Sedco, DH97



1702076 SP35B, DMPS-AF PNP



USIONE Sensor, Slider, Motion Presence, AIR, Optex



USOARHI Sensor Cover I-ONE Rainhood



US08-0989-01 Weather Hood, MS Sedco



USOPHCISENSOR Sensor Cover, I-ONE, Optex



SENSORS



1701813 Install Kit for SP33 DMPS



1702071 Install Kit for SP35MB

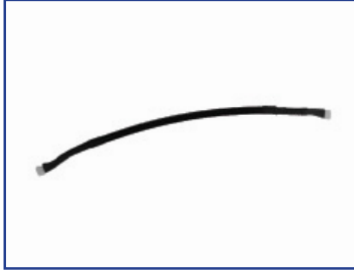

1701817 Cable for SP33 DMPS



1702070 906 PNP Cable for Besam SP35MB-OP



1701818 Sensor Loop Kit for SP33 DMPS



1702073 Door Loop Kit for Besam SP35MB-OP



1701826 Cover only for SP33 & SP34 DMPS



Replaces 1701820



1701819 Sensor Head only for SP33 DMPS



1701737 Besam SA31-OP, OPS



1701734 Besam SP34-OP, OPS-Mount



1701735 Besam SP34-OP, PNP Cable



1701733 Besam SP32-M-OP, DMPS, 43"



1702487 Lens for above, 44"



1702780 End Cap Kit for above



Remember - search for all parts online at www.besam-usa.com

© ASSA ABLOY Entrance Systems US Inc.

**HARDWARE
ACTIVATION & SAFETY DEVICES**

ASSA ABLOY

The global leader in
door opening solutions

SENSORS



1701814 SP33, 904 Interface w/
Harness



1702069 SP35MB, 906 Inter-
face w/Harness



1701816 SP33-OP, LV Cable



1702072 SP35MB-OP, LV Cable



1701826 SP33 & SP34, Cover
Only



1701977 SP-33-OP, AL Door
Adapter

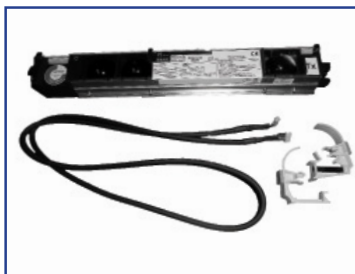

1701739 Besam SP32-M-OP,
DMPS ExtSafety



1702040 Besam SP32-DMPS
Power Cable



1702041 Besam SP32-DMPS
Comm Cable 10"



1702042 Besam SP32-DMPS
Comm Cable 35"



1701822 Besam SP34,
OC-913 Interface



1701824 Comm Cable Besam
SP34 to OC-913

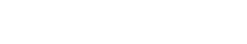

phone: 888-732-3726

parts.na.besam@assaabloy.com

fax: 800-304-9459

© ASSA ABLOY Entrance Systems US Inc.

3B Rev D

SENSORS



OBS

USOA202C Sensor, Prosafe Active, IR, Optex - **OBSELETE**

USHCOA202BK Cover, Sensor, OA202C, BK -Use **USHCOA203BK**

USHCOA203BK Cover, Sensor, Optex, BK



USOA601C Sensor, Proswing, Active, IR, Optex



USHCOA601BK Cover, Sensor, OA601, Optex, BK



USCRYSTAL Sensor, Crystal BEA



USB700033 Cover, Sensor Crystal



Terminate When Exhausted

USIRIS Sensor, Iris, BEA



Obsolete

USDK12 Sensor, DK12, BEA
Replaced by US02-0274-02



USWHU Weather Hood, Sensor, DK12 & CPSS



USFOCUS Sensor, Focus, BEA (Top)



USFOCUS2 Sensor, Recessed, Focus 2, BEA (Bottom)



1702871 Ceiling Accessory for SP53M (IXIO)



**HARDWARE
ACTIVATION & SAFETY DEVICES**

ASSA ABLOY

The global leader in
door opening solutions

SENSORS



USBLACKHAWKB1 Sensor, Blackhawk (1-Way), Com, BEA



USBLACKHAWKB2 Sensor, Blackhawk (2-Way), BEA**



**Blackhawk 2-Way Contains:
(4) Blackhawk Sensors,
(1) Transformer, (1) Hub,
(6) Harnesses (4 Sensor,
1 Output, 1 Encoder)



10.1026 Hub, Blackhawk, w/Transformer



10.1030 Sensor Only, Blackhawk, Presence



US02-0274-06 Besam SA51 Activation/Motion Sensor, Logo



USEAGLE Besam SA51 Activation/Motion Sensor, Plain



USBEAGLESPACER Sensor Spacer, Eagle, BEA



USB10ERC Cover, Sensor Eagle, Cover Only, Exterior



USBEMB Angle Bracket, Sensor Mount, Eagle, BEA



USB700167 Cover, Sensor Eagle, Cover Only



USBERA Cover, Sensor Eagle Rainhood



SENSORS

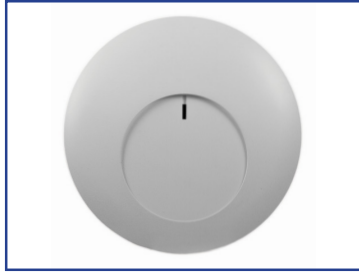

USB10ECA Sensor Mount, Drop Ceiling, Eagle, BEA



US02-0274-19 Sensor, Superscan I, 32", BEA



US02-0274-21 Sensor, Superscan I, 34.5", BEA



US02-0274-20 Sensor, Superscan I, 40", BEA



US02-0274-22 Sensor, Superscan I, 42", BEA



US02-0274-23 Sensor, Superscan I, 46", BEA



US02-0274-03 Sensor, Superscan II, 32", BEA



US02-0274-14 Sensor, Superscan II, 34.5", BEA



US02-0274-08 Sensor, Superscan II, 40", BEA



US02-0274-15 Besam SP52 Door Mounted Presence Sensor, 42"



US02-0274-16 Sensor, Superscan II, 46", BEA



US02-0274-17 Sensor, Superscan II, 48", BEA



USB700203 Sensor Lens, Superscan, 33"



USB700138 Sensor Lens, Superscan, Per Foot



USBMASTER Master Unit, Superscan



US02-0274-24 Besam SP52 Extended Safety Module



Remember - search for all parts online at www.besam-usa.com

© ASSA ABLOY Entrance Systems US Inc.

**HARDWARE
ACTIVATION & SAFETY DEVICES**

ASSA ABLOY

The global leader in
door opening solutions

SENSORS



US02-0274-02 Besam SP53 Overhead Presence Sensor



US02-0274-04 Besam SP53 OPS- Mount



USB700006 Sensor End Cap, Bodyguard, Superscan, LH, BEA



USB700005 Sensor End Cap, Bodyguard, Superscan, RH, BEA



USB10CAPKIT Sensor End Cap Kit, Bodyguard, Superscan, BEA (Kit Shown)

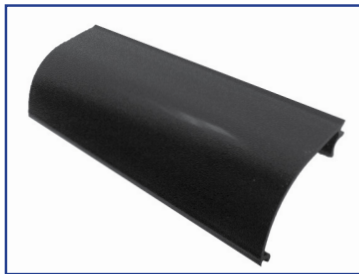

USB700207 Lens, Sensor Bodyguard, 4-7/8" Long

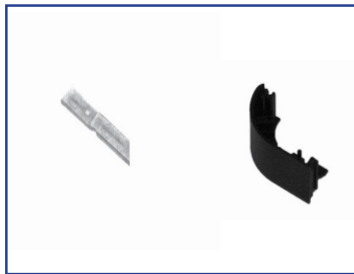

USB700180 Sensor, Lite Pipe, Bodyguard (Left)



USB700179 Cover, Sensor Lite Pipe, Bodyguard (Right)



USBEDPS1 Universal Lockout, Programmable, Swing Door



US15-0511-01 Quick Connect Harness - Not for BEA



USBFJN1406 Sensor Protector, Black



USBEDPSRK Universal L/O, Programmable, Dual Egress, Swing Door



phone: 888-732-3726

parts.na.besam@assaabloy.com

fax: 800-304-9459

© ASSA ABLOY Entrance Systems US Inc.

SENSORS

SP58-M Single PNP (LZR Microscan) Kit Parts:

- 1702795 Single Kit (DA only)
- 1702796 Pair Kit (DA only)



ITEM	Baan #	Description	Barcode
1	1702810	SP58-M Door Loop / Cap Kit	
2	1702799	SP58-M Left Hand Sensor (Blue LED)	
3	1702803	SP58-M Slave Sensor Harness	
4	1702800	SP58-M Right Hand Sensor (Blue LED)	
5	1702804	SP58-M PNP Door Control Harness	
6	1702802	SP58-M Master Sensor Harness	
7	1702807	SP58-M Approach SA-51 Sensor Harness	
8	1702801	SP58-M Hub	

SP58-M Single Universal (LZR Microscan) Kit Parts:

- 1702797 Single Kit
- 1702798 Pair Kit

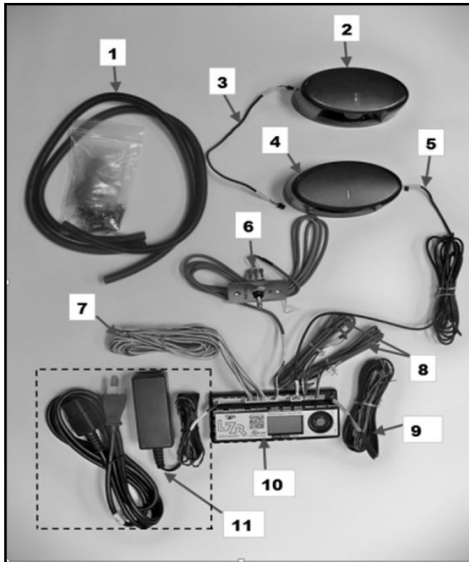

ITEM	Baan #	Description	Barcode
1	1702810	SP58-M Door Loop / Cap Kit	
2	1702825	SP58-M Left Hand Sensor (Green LED)	
3	1702803	SP58-M Slave Sensor Harness	
4	1702826	SP58-M Right Hand Sensor (Green LED)	
5	1702802	SP58-M Master Sensor Harness	
6	1702813	SP58-M On/Off/Hold/Open Switch (Universal)	
7	1702805	SP58-M Universal Door Control Harness	
8	1702807	SP58-M Approach SA-51 Sensor Harness	
9	1702806	SP58-M System Harness	
10	1702801	SP58-M Hub	
11	1702812	SP58-M Power Supply Harness	
12	1702809	SP58-M Home Switch (Universal) Magnet	

Remember - search for all parts online at www.besam-usa.com

© ASSA ABLOY Entrance Systems US Inc.

**HARDWARE
ACTIVATION & SAFETY DEVICES**

ASSA ABLOY

The global leader in
door opening solutions

SAFETY DEVICES



US02-0136-02 Beam Kit,
Microcell 1, w/Jamb Caps incl., 15'



US02-0136-03 Beam Kit,
Microcell 1, w/Jamb Caps incl., 30'



USBMICROCELL1D Beam Kit,
Microcell, Double, 15' Cable, BEA



US02-0136-01 Beam Kit,
Microcell, Double, 30' Cable, BEA



US02-0274-18 Beam Kit, SBK30,
Without IFB, BEA



USSBK111 Holding Beam,
1 Channel, BEA



USB200038 Beam, Microcell,
Cable Set Only, BEA



US02-0136-20 Jamb Cap Kit,
Beam, Microcell, BEA



USB200036 Beam, Microcell,
Receiver Only, BEA (Top)



USB200037 Beam, Microcell,
Transmitter Only, BEA (Bottom)



USB200035 Beam, Microcell,
Transmitter & Receiver Set, BEA



US02-0136-22 Emitter Cable



phone: 888-732-3726

parts.na.besam@assaabloy.com

fax: 800-304-9459

© ASSA ABLOY Entrance Systems US Inc.

HARDWARE
ACTIVATION & SAFETY DEVICES

ASSA ABLOY

The global leader in
door opening solutions

SAFETY DEVICES



US02-0136-21 PC Board,
Microcell



USOS12C Beam Kit, Single
23' Cable, Optex (Shown)



USOAOS12C Optex Beam,
Control Only



USOS12CSET2 Beam Kit,
Double 23' Cable, Optex



USSH-7MC Beam Eyes w/23'
Cable, Optex



USSH10MC Beam Eyes w/33'
Cable, Optex



USOSBHBLK Beam Holder,
Surface, Wide, Optex, Black



USOSBHGR Beam Holder,
Surface, Narrow, Optex, Gray

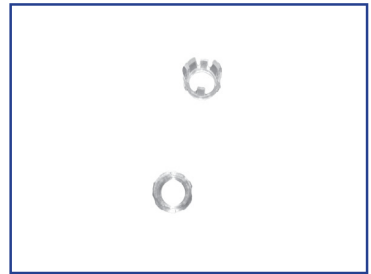

USSHTRCL Beam Ring,
Plastic w/Clip, Optex



USPOC Beam Ring, Chrome
Pair, Optex



Remember - search for all parts online at www.besam-usa.com

© ASSA ABLOY Entrance Systems US Inc.

**HARDWARE
ACTIVATION & SAFETY DEVICES**

ASSA ABLOY

The global leader in
door opening solutions

MODULES

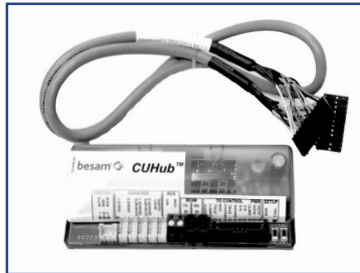

US02-0583-02 Plug N Play Module, CUHub, SM900



US02-0583-13 Switch Kit, CUHub, 3 Position Toggle

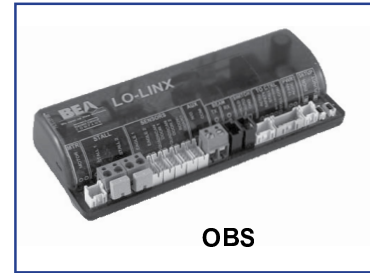

OBS

USBLO-LINX LO-Linx Board and Cables - Obsolete



USBLINX2 Relay, Module, BEA MCLinx 2

****While Supplies Last****



USBR3 Module, 3 Relay Logic Programmable



USTD100D Relay, Time Delay, TD-100D



USLE21 Relay, Lockout, BEA, Low Energy



USMC10 Relay, Module, BEA Time Delay



USMC25 Relay, Module, BEA Lock Interface

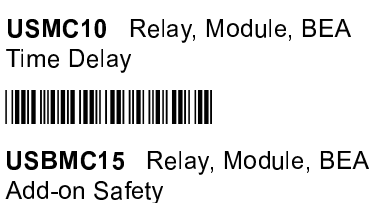

USBMC15 Relay, Module, BEA Add-on Safety

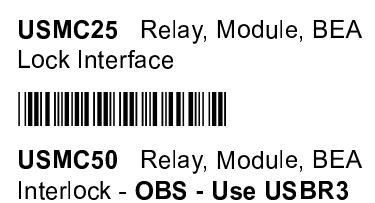

USMC50 Relay, Module, BEA Interlock - **OBS** - Use **USBR3**

phone: 888-732-3726

parts.na.besam@assaabloy.com

fax: 800-304-9459

© ASSA ABLOY Entrance Systems US Inc.

MODULES



USLO21 Relay, Lockout, BEA
Lockout



USLO21P Relay, Lockout,
BEA, LO21P



USBLO21S Relay, Lockout,
BEA, Stanley



USLO21U Relay, Lockout, BEA
Universal



US02-0274-01 Relay, Lockout,
BEA, Besam

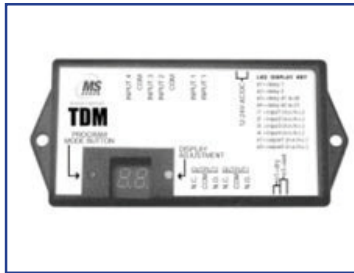

USTDM Module, Time Delay

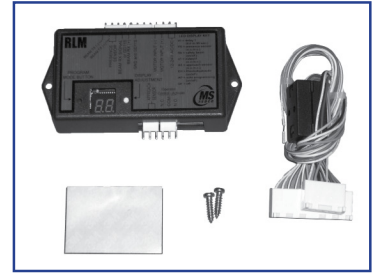

USORLM Lockout Relay,
Optex 601 Sensor



HARDWARE
ACTIVATION & SAFETY DEVICES

ASSA ABLOY

The global leader in
door opening solutions

PUSH PLATES & RELATED



USPBJML 1.5" x 4.75" Jamb Plate w/HC, (Plate Only)



USPBJL 1.5" x 4.75" Jamb Plate, Large HC Logo, (Plate Only)



USPBJM1 1.5" x 4.75" Jamb Plate w/HC Logo, (Plate Only)



USPBJ10CP Push Plate, Jamb, Champagne Pearl, BEA, (Plate Only)



USPBJMS1 Push Plate, 1.75" x 4.5", Jamb PTO, BEA, (Plate Only)



USPBJ1 Push Plate, Jamb PTO/HC, BEA, (Plate Only)



USPBJ1B Push Plate, Jamb PTO/HC, Blue, BEA, (Plate Only)



USPBJMSLL Push Plate, Jamb, HC Logo, BEA, (Plate Only)



USPBJ10 Push Plate, Jamb, Plain, BEA, (Plate Only)



USPBJ Push Plate, 1.5" x 4.75", Jamb PTO, BEA, (Plate Only)



HARDWARE
ACTIVATION & SAFETY DEVICES

ASSA ABLOY

The global leader in
door opening solutions

PUSH PLATES & RELATED



USPBJREV Push Plate, Jamb, Push to Slow, Brail, BEA, (Plate Only)



USBOXJAMBSM Push Plate Box, Jamb Surface Mount, BEA



USBBOXJAMBFM Push Plate Box, Flush Mount (Right)



USBOXJAMBST Push Plate Box, Jamb Revolver, BEA



USCM2200 Key Switch, Narrow Jamb, SS, SPST, NO



US02-1699-03 Wave Switch, Jamb Mount, w/WTO Logo



US02-1699-04 Wave Switch, Wall Mount, w/WTO Logo



US02-1699-06 Jamb Box, Surface Mounted



USBMS08U Sensor, Single/Double, Touchless, BEA, MagicSwing



USPBO24L Push Plate, 2" x 4", Superscan, HC Large Logo Only, (Plate Only)



Remember - search for all parts online at www.besam-usa.com

© ASSA ABLOY Entrance Systems US Inc.

HARDWARE
ACTIVATION & SAFETY DEVICES

ASSA ABLOY

The global leader in
door opening solutions

PUSH PLATES & RELATED



USPBDGP1 Push Plate, 4" x 4",
Superscan, Vestibule, PTO/HC,
(Plate Only)



US59H Push Plate, 4" Square,
Logo, HC/PTO, (Plate Only)



US59P Push Plate, 4" Square,
Logo, PTOD, (Plate Only)



US59HUS4 Push Plate, 4"
Square, PTO/HC, Satin Brass
Finish, Plate Only (Special Order)



USBBOXDG4H Surface
Mount Box, 4" x 4" x 1.5", BK



USPUSHPLATE45 Push Plate
Package, 4" Square, w/USPBS45
Plates



USAABRL Push Plate, 4.5"
Square, HC, Push to Slow,
(Plate Only) **OBS**



USPBS45B 4.5" Blue Square
w/PTO Text, (Plate Only)



USPBS45POD Push Plate, 4.5"
Square, PTO Door, BEA,
(Plate Only)



HARDWARE
ACTIVATION & SAFETY DEVICES

ASSA ABLOY

The global leader in
 door opening solutions

PUSH PLATES & RELATED



USPBS45 Push Plate, 4.5" Square, PTO Text, BEA, (Plate Only)



USPBS451B Push Plate, 4.5" Square, PTO/HC, Blue, BEA, (Plate Only)



USPBS451 Push Plate, 4.5" Square, PTO/HC Logo, BEA, (Plate Only)



US59HUS32 Push Plate, 4.5" Square, PTO/HC, Polished SS, (Plate Only)



US59HSS Push Plate, 4.5" Square, PTO/HC, SS, (Plate Only)

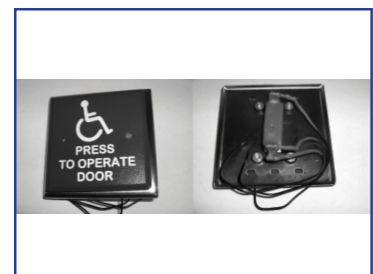

USMS59PWR Push Plate, 59H, w/Weatherproofing, (Plate Only)



US216 Push Plate, 4.5" Square, Infrared, Touchless, SS, Sedco,



USMS1020 Box, Surface Mount, 4.5" Square, 1020



USBOX45SQSM Push Plate Box, 4.5" Square, Surface, BEA



Remember - search for all parts online at www.besam-usa.com

© ASSA ABLOY Entrance Systems US Inc.

HARDWARE
ACTIVATION & SAFETY DEVICES

ASSA ABLOY

The global leader in
door opening solutions

PUSH PLATES & RELATED



1007597 Push Plate, 4.75" Square, PTO, BEA, (Plate Only)



Was **USPBS**



1007598 Push Plate, 4.75" Square, PTO/HC, BEA, (Plate Only)



Was **USPBS1**



USPBS1B Push Plate, 4.75" Square, PTO/HC, Blue, BEA, (Plate Only)



USPBSLL Push Plate, 4.75" Square, HC, BEA, (Plate Only)

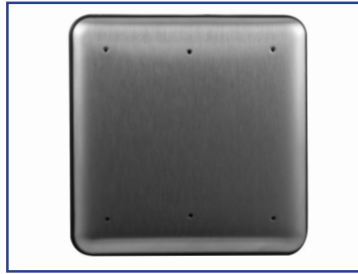

USPBS10 Push Plate, 4.75" Square, Plain, BEA, (Plate Only)



USEMS4751 4.75" Square Panther Push Plate Assembly, PTO/HC, (Plate Only)



USBBOXSQ475FM Push Plate Box, 4.75" Square, Flush, BEA



USBBOXSQ475SM Push Plate Box, 4.75" Square, Surface Mount

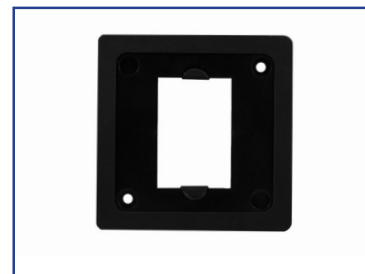

USWRSQ475 Weather Ring, Push Plate, 4.75"



phone: 888-732-3726

parts.na.besam@assaabloy.com

fax: 800-304-9459

© ASSA ABLOY Entrance Systems US Inc.

HARDWARE
ACTIVATION & SAFETY DEVICES

ASSA ABLOY

The global leader in
door opening solutions

PUSH PLATES & RELATED

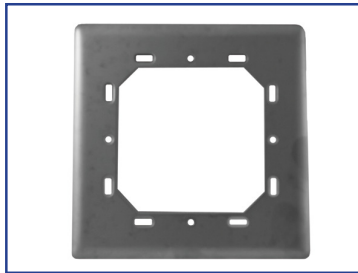

USBRING Push Plate,
4.75" Beauty Ring, BEA



USBPBR45LL Push Plate,
4.5" Round, Large HC Logo,
(Plate Only)



USBPBR45 Push Plate, 4.5"
Round, PTO, (Plate Only)

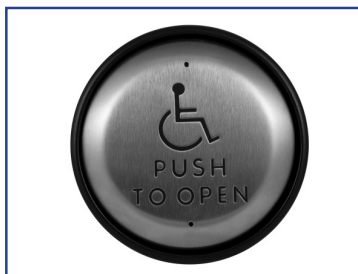

USPBR451 Push Plate, 4.5"
Round, PTO/HC, BEA,
(Plate Only)

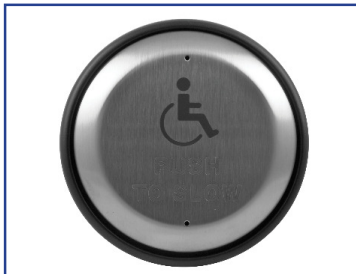

USBPBR4510PTS 4.5" Push
Plate, Round, Push to Slow,
(Plate Only)



USBESCUTCHEON45 4-1/2"
Round Escutcheon, (Plate Only)



USPBR10 Push Plate, 6"
Round, Plain, BEA, (Plate Only)



USPBR Push Plate, 6" Round,
PTO, BEA, (Plate Only)

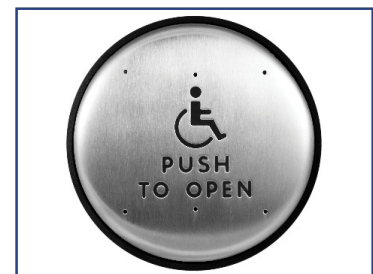

1007599 Push Plate, 6"
Round, PTO/HC, BEA,
(Plate Only)



Was USPBR1

Remember - search for all parts online at www.besam-usa.com

© ASSA ABLOY Entrance Systems US Inc.

HARDWARE
ACTIVATION & SAFETY DEVICES

ASSA ABLOY

The global leader in
door opening solutions

PUSH PLATES & RELATED



USEMR61 6" Round Panther
Push Plate Assembly, PTO/HC,
(Plate Only)



75-02-101 Push Plate, 6"
Round, HC Logo, BEA,
(Plate Only)



USBOX6RNDFM Push Plate
Box, 6" Round, Flush, BEA



USBOX6RNDSM Push Plate
Box, 6" Round, Surface, BEA



USBBOX45RNDSM Push Plate
Box, 4.5" Round, Surface, BEA

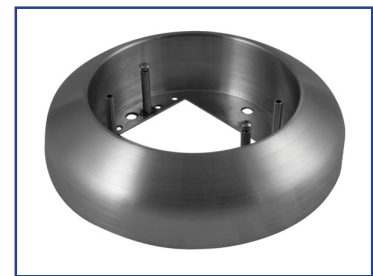

USBESCUTCHEON6 6" Round
Escutcheon

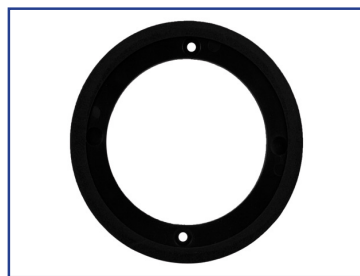

USWRRRND6 Weather Ring,
for 6" Round Push Plate



USB30.0385 Switch, Push Plate
Repair, BEA



USBKEYPAD Indoors Keypad



phone: 888-732-3726

parts.na.besam@assaabloy.com

fax: 800-304-9459

© ASSA ABLOY Entrance Systems US Inc.

HARDWARE
ACTIVATION & SAFETY DEVICES

ASSA ABLOY

The global leader in
door opening solutions

PUSH PLATES & RELATED



USBKEYPADWR Outdoors Keypad



USBFLYKITB Fly Kit- One Box Solution, Black



USBMAGDE1 Delayed Egress Maglock



1008061 Push Plate, Besam, Sq 4.75 PTO/HC

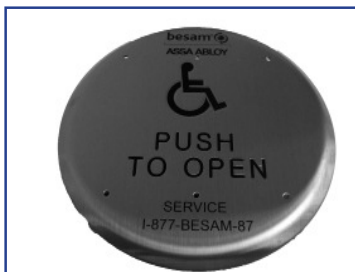

1008062 Push Plate, Besam, Round 6" PTO/HC



Remember - search for all parts online at www.besam-usa.com

© ASSA ABLOY Entrance Systems US Inc.

HARDWARE
ACTIVATION & SAFETY DEVICES

ASSA ABLOY

The global leader in
door opening solutions

TRANSMITTERS & RECEIVERS



USRD433 Receiver, 433 MHz



USR300 Receiver, 300 MHz,
24 AC/DC, BEA



OBS

USBR390 Receiver, 390 MHz,
24 VAC, BEA -- **Superseded by**
USRD433



USTD433PB3V Transmitter,
w/3V Battery, 433 MHz

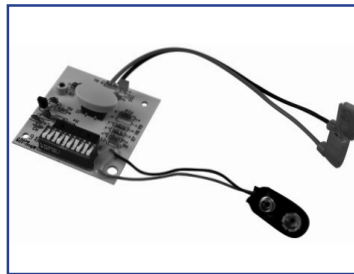

UST300PB Transmitter,
300 MHz, w/Connector, BEA



OBS

UST390PB Transmitter,
390 MHz, w/Connector, BEA --
Superseded by USTD433PB3V

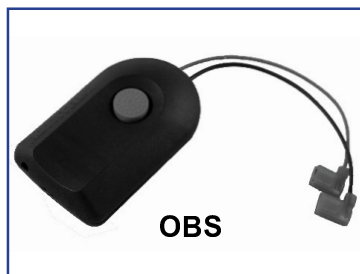

OBS

USTD390WC Transmitter,
390 MHz, w/Connector, BEA
Superseded by USTD433PB3V



USTD390HH Transmitter,
Digital, 390 MHz



phone: 888-732-3726

parts.na.besam@assaabloy.com

fax: 800-304-9459

© ASSA ABLOY Entrance Systems US Inc.

HARDWARE
ACTIVATION & SAFETY DEVICES

ASSA ABLOY

The global leader in
door opening solutions

TRANSMITTERS & RECEIVERS



USTD433HH1 Transmitter,
1 Button, 433 MHz



USTD433HH2 Transmitter,
2 Button, 433 MHz



USTD433HH3 Transmitter,
3 Button, 433 MHz



USTD433HH4 Transmitter,
4 Button, 433 MHz



UST300HH4 Transmitter, Hand
Held, 4 Button, 300 MHz, BEA



UST300HH Transmitter, Hand
Held, 1 Button, 300 MHz, BEA



UST300HHDBL Transmitter, Hand
Held, 2 Button, 300 MHz, BEA



USTD433PB9V Transmitter,
433 MHz, w/9V Battery

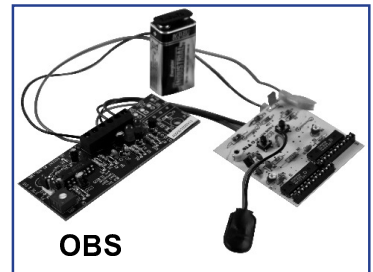

OBS

USDFCXTR Transmitter, Dual
Sequencer, BEA



UST300KEYCHAIN Transmitter,
300 MHz, w/o Connector, BEA



USBT300MINIPB Transmitter,
Mini, 12V, 300 MHz, BEA



USCMRX91 Receiver,
915 MHz, Camden



Remember - search for all parts online at www.besam-usa.com

© ASSA ABLOY Entrance Systems US Inc.

HARDWARE
ACTIVATION & SAFETY DEVICES

ASSA ABLOY

The global leader in
door opening solutions

TRANSMITTERS & RECEIVERS



USCMTX1 Transmitter,
1 Channel, 10 Code, 318 MHz

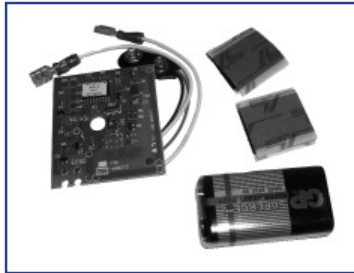

USCMTX7 Transmitter,
Attached Switch, 318 MHz

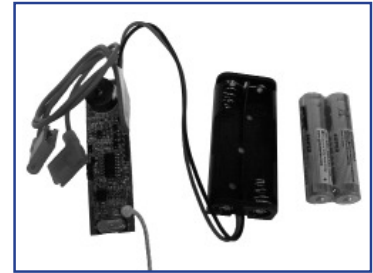

USCMTX9 Transmitter,
Wall Switch, 915 MHz

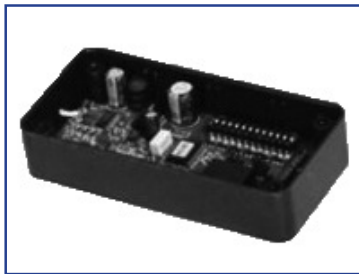

USMSCPRX Receiver



USMSCPTX Transmitter, Clear
Path 4" Wall (was **USTX323**)



HARNESSES



USB150114 Harness, 6', BEA, Wizard



US02-0583-14 Harness, CU2 Sync, 5', SM900



US02-0583-09 Harness, CUHub to BG3 Y, 2 BG's



US02-0583-11 Harness, CUHub to Bodyguard3



US02-0583-05 Harness, CUHub to CU2 Control



US02-0583-08 Harness, CUHub to Eagle



US02-0583-10 Harness, CUHub to Superscan



US02-0640-05 Quick Disconnect, UltraView



US02-0640-04 Cable, Black, 6', UltraView



Remember - search for all parts online at www.besam-usa.com

© ASSA ABLOY Entrance Systems US Inc.

HARDWARE
ACTIVATION & SAFETY DEVICES

ASSA ABLOY

The global leader in
door opening solutions

HARNESSES



US02-0640-03 Cable, Gray, 16',
UltraView



US15-0511-01 Quick Connect
Harness

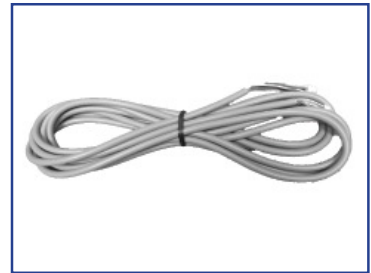

1702472 PNP 13' SC32M-
SC32M Harness



1702473 PNP 9' SC32M-
SC32M Harness

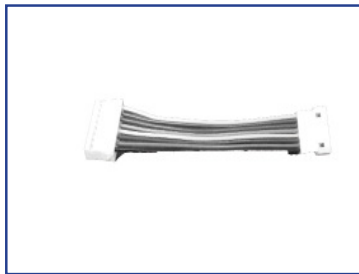

1702474 Adapter SC32M-
SC32M Harness



1702187 Cable, SC32-M/
SR221-2



USB205345 Pigtail Adapter,
SC53M, IXIO



HARDWARE ACTIVATION & SAFETY DEVICES

ASSA ABLOY

The global leader in
door opening solutions

ACCESSORIES



US02-0274-07 Remote Control,
Sensors, BEA



USSPOTFINDER Sensor,
Spot Finder, BEA



USBDPG50 Force Gauge,
Door Pressure, 50 Lbs.

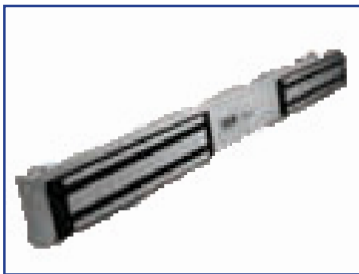

USBMAGLOCK6 Lock, Magnetic,
Dual, 12/24VDC 600, BEA



USB10MAGLOCK6UL Lock,
Magnetic, Dual, 24VDC, 600 Lb
UL Rated, BEA



USBMAGLOCK3 Lock, Magnetic,
Single, 12/24VDC, BEA



USMAGLOCK1 Lock, Switch,
Magnetic, 1200 Lb, BEA



USBSWITCH1076 Door
Position Switch, Magnetic, 3/4"
Round, Flush Mount, SPDT



USBSWITCH1084 Door
Position Switch, Magnetic,
Rectangular, Surface, SPDT



Remember - search for all parts online at www.besam-usa.com

© ASSA ABLOY Entrance Systems US Inc.

**HARDWARE
ACTIVATION & SAFETY DEVICES**

ASSA ABLOY

The global leader in
door opening solutions

ACCESSORIES



USBOLLARDBK Post,
42"H x 6"W x 4"D, BK, BEA



USBOLLARDBZ Post,
42"H x 6"W x 4"D, BZ, BEA



USBOLLARDCL Post,
42"H x 6"W x 4"D, CL, BEA



USB500071 Bollard Hardware
Pack



US02-0274-12 Transformer, 24V,
40VA, BEA

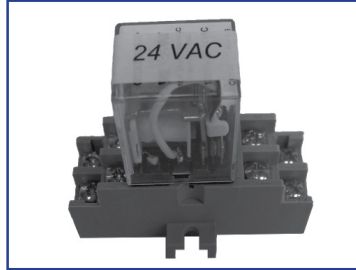

USREL24VAC Relay Kit,
24VAC, DPDT w/Base



USREL24VDC Relay Kit,
24VDC, DPDT w/Base



US12VAC Transformer, 12V,
150mA



USB24VAC Transformer, 24V,
40VA - Use **US02-0274-12**



USBKEYPAD Keypad for Indoors



USBKEYPADWR Keypad for
Outdoors



TABLE OF CONTENTS

Dor-O-Matic

Slide

- Astroslide - Chain or Belt Drive
- 96K - Belt Drive

Swing

- Astroswing - High Energy
- Mid-Swing - High Energy
- Senior Swing - Low Energy
- Junior Swing - Low Energy
- AstroFold - Bi-fold
- BenchMark and Ascent - Low Energy

Misc.

DOR-O-MATIC

ASSA ABLOY

ASTROSLIDE

The global leader in door opening solutions



D70586400 Control, Computerized, Chain Drive, Rebuilt



D70587400 Control, Computerized, Belt/Chain Drive, Rebuilt



D70588400 Control, Computerized, Chain Drive, Rebuilt



D70590400 Control, Non-computerized, Rebuilt



D70596400 Control, Computerized, Gearbox/Motor, OS, Rebuilt



D70598400 Control, Universal Slider 100, w/Memory, Rebuilt



D72620400 Gearbox, Motor, Computerized Belt Drive, Rebuilt



D96991400 Gearbox/Motor, Dunker, Rebuilt



D72187400 Motor, Chain & Belt Drive, Rebuilt



DOR-O-MATIC

ASSA ABLOY

ASTROSLIDE

The global leader in
door opening solutions

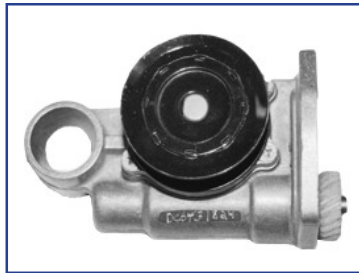

D72615400 Gearbox, Belt Drive, Rebuilt

Replaced by **D72620400**
See Pg. 1



D72188400 Gearbox, Motor, Chain Drive, Rebuilt



D4204100869 Chain, Link, Master Link



D4204100313 Cable/Chain Assembly, Universal, Single, 7'



D4204102020 Pulley, Idler for Cable Astros

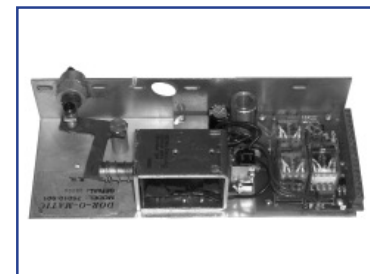

D75010401 Lock, Electric, 12V, FSE, RH, Rebuilt



D4204118653 Wheel, Anti-jar

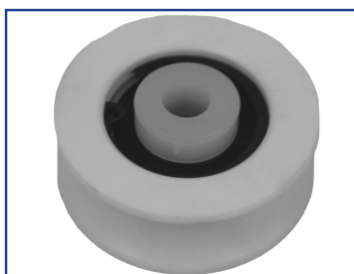

D4204109746 Roller, Hanger w/Bushing

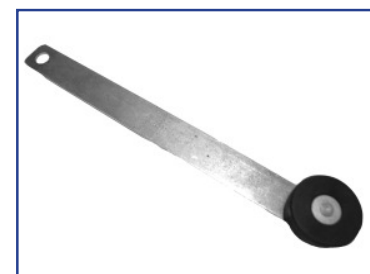

D4204110674 Arm, Swing



Remember - search for all parts online at www.besam-usa.com

© ASSA ABLOY Entrance Systems US Inc.

DOR-O-MATIC

ASSA ABLOY

ASTROSLIDE

The global leader in door opening solutions

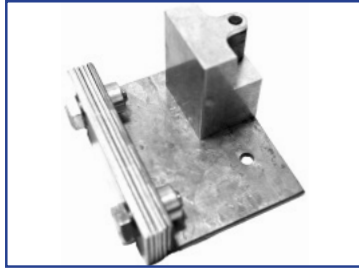

D71630901 Roller, Block, RH

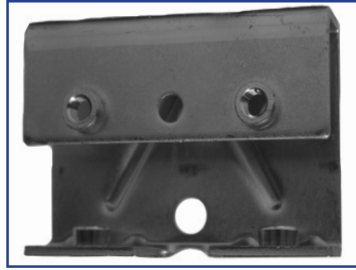

D4204109752 Hanger, Roller, Bracket



D4204100379 Hanger, Roller, Blue



D4204100148 Bolt, Anti-rise



D4204109715 Adjustment Tool, Door Height



D4204100707 Hanger, Alignment Block



D4204115460 Idler, Wheel, Belt Drive



D4204115764 Bracket, Drive Belt



D4204115784 Idler, Bracket



ASTROSLIDE

The global leader in door opening solutions



D4204100831A Track, Bottom Guide, FBO, CL



D4204108946 Guide, Bottom

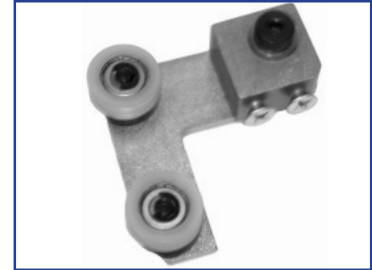

D4204104975 Pivot, Complete, LH (Shown)



D4204104976 Pivot, Complete, RH



D4204109770 Pivot, Top, Sidelite, LH



D4204109771 Pivot, Top, Sidelite, RH

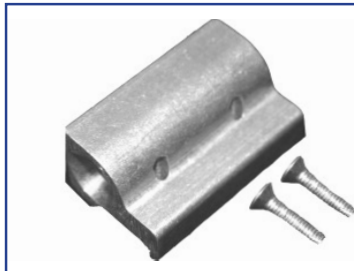

D4204109772 Pivot, Bottom, Sidelite, RH



D4204109773 Pivot, Bottom, Sidelite, LH



D4204101996 Catch, Panic, Magnetic

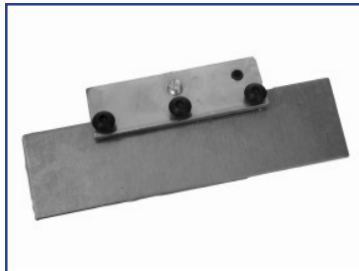

D4204108593 Catch, Panic, Clapper Plate & Magnet

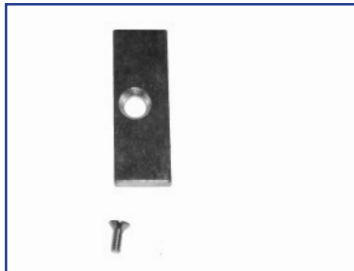

D4204109419 Plate, Panic, Clapper

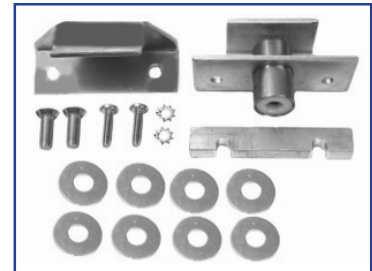

D4204120316 Ball, Detent, Retro Kit



Remember - search for all parts online at www.besam-usa.com

© ASSA ABLOY Entrance Systems US Inc.

DOR-O-MATIC

ASSA ABLOY

The global leader in
door opening solutions

ASTROSLIDE

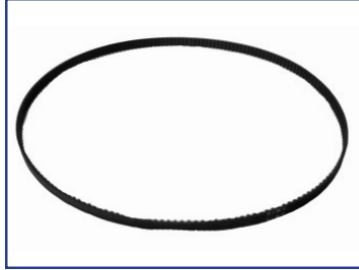

D4204103797 Belt, Timing,
Microswitch



D4204109417 Pin, Hanger,
Bullet Type



DOR-O-MATIC

ASSA ABLOY

96K

The global leader in door opening solutions



D84657400 Control, Digital, Rebuilt

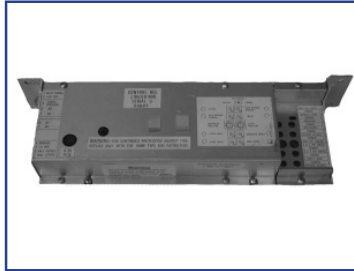

D96010400 Control, Slider, 9500, Rebuilt



D84732-400R Motor/Gearbox, Digital, Rebuilt



D96175400 Gearbox/Motor, 24V, w/Flat Mounting Bracket, Rebuilt



D96005-400R Transformer, Rebuilt



D84217900 Switch, 4 Position, Slider



D96537R Roller, Hanger, w/Shaft, N/S, Digital, 2" Dia.



D96135R Roller, Hanger, Roller Only, Outswing, Analog 2-1/4" Dia



D4204100092 Guide, Bottom, w/Nylon Block



Remember - search for all parts online at www.besam-usa.com

© ASSA ABLOY Entrance Systems US Inc.

DOR-O-MATIC

ASSA ABLOY

ASTROSWING

The global leader in door opening solutions



D81001401 Operator, Non-computerized, RH, Rebuilt



D81001402 Operator, Non-computerized, LH, Rebuilt



D81002401 Operator, 120V Motor, computerized, RH, Rebuilt



D81002402R Operator, 120V Motor, Computerized, LH, Rebuilt

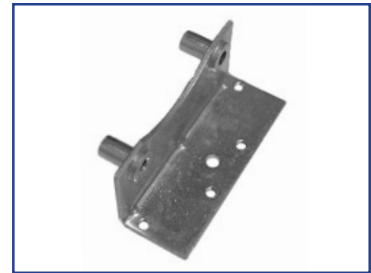

D81309000 Bracket, Mounting, Front, 3 3/4"

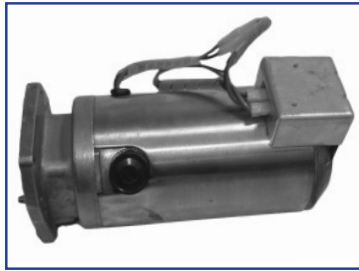

D81560401 Motor, Computerized, RH, Rebuilt



D81560402 Motor, Computerized, LH, Rebuilt



D81270-400R Control, Non-computerized, Rebuilt



D81288400 Control, Non-computerized, Rebuilt



D81540400 Control, Computerized, Rebuilt

Replaced by D84540400



D81650400 Control, Non-computerized, Rebuilt



D84540400 Control, Micro-computerized, Rebuilt



Remember - search for all parts online at www.besam-usa.com

© ASSA ABLOY Entrance Systems US Inc.

DOR-O-MATIC

ASSA ABLOY

ASTROSWING

The global leader in
door opening solutions



D84555400 Control, Computerized, Rebuilt



D84557400 Control, Super Nova, Rebuilt

Obsolete



D84580400 Control, Universal, Rebuilt



D85420400 Control, Universal Rebuilt



D85425400 Control, Computerized, Rebuilt



D77155400 Sensor, Rail Control, Rebuilt



D77153400 Sensor, Rail Control, Rebuilt

Replaced by D77155400



D83185900 Switch, On/Off/ Hold



D83190900 Switch, Rocker, Narrow, Rebuilt



ASTROSWING

The global leader in door opening solutions



D77140900 Harness, Activate Safety



D85398600 Cable, Slave Interface



D81322900 Stop, Panic, Break-away

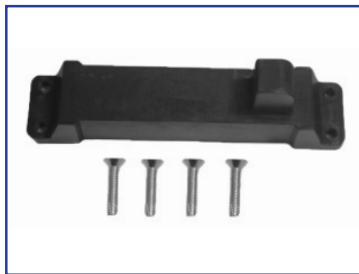

D81118900 Stop, Fixed

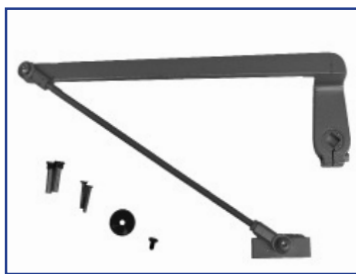

D81170101 Arm, SA, Outswing, RH

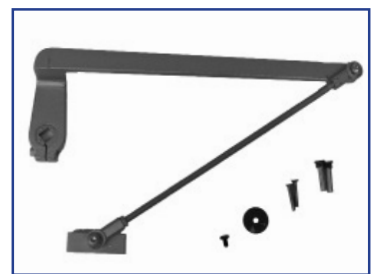

D814609479 Arm, Push Surface, RH, CL



D81460938 Arm, Push Surface, RH, CL



D81460959 Arm, Push Surface, LH, CL



D880000 Arm, Non-panic, for 6613 & 6683



D81185900 Pivot, Bottom, Complete



Remember - search for all parts online at www.besam-usa.com

© ASSA ABLOY Entrance Systems US Inc.

DOR-O-MATIC

ASSA ABLOY

ASTROSWING

The global leader in
door opening solutions



D10161000 Pivot, Bearing



MID-SWING

The global leader in door opening solutions



D83800401 Operator, RH, Rebuilt



D83800402 Operator, LH, Rebuilt



D81309000 Bracket, Mounting, Front, 3 3/4"



D84590400 Control, Universal, Rebuilt



D85455400 Control, Computerized, Rebuilt



D84219900 Switch, Key, 3 Position, Swing, On/Off/Hold



D87390900 Switch, Rocker, 3 Position, On/Off/Hold



D885100 Arm, Composite for D88000



D888100 Arm, Mounting Plate for D88000



D880000 Arm, Non-panic, for 6613 & 6683



Remember - search for all parts online at www.besam-usa.com

© ASSA ABLOY Entrance Systems US Inc.

DOR-O-MATIC

ASSA ABLOY

The global leader in
door opening solutions

MID-SWING



D81322900 Stop, Panic,
Break-away

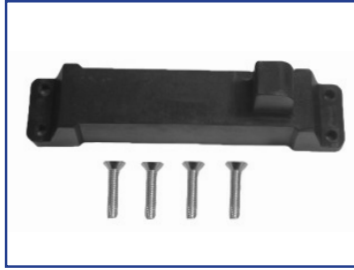

D81118900 Stop, Fixed



SENIOR SWING

The global leader in door opening solutions



D81007401 Operator, RH, Rebuilt



D81007402R Operator, LH, Rebuilt

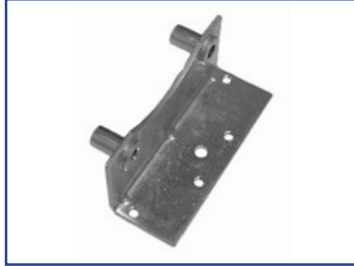

D81309000 Bracket, Mounting, Front, 3 3/4"



D710164 Control, Digital, Rebuilt



D84561400 Control, Rebuilt
Replaced by **D84570400**



D84570400 Control, Universal, Rebuilt



D85440400 Control, Rebuilt



D85445400 Control, Rebuilt



D880000 Arm, Non-panic, for 6613 & 6683



D81301000 Bracket, Mounting, Rear



Remember - search for all parts online at www.besam-usa.com

© ASSA ABLOY Entrance Systems US Inc.

DOR-O-MATIC

ASSA ABLOY

JUNIOR SWING

The global leader in
door opening solutions



D84105979 Arm, Pull



DOR-O-MATIC

ASSA ABLOY

ASTRO FOLD

The global leader in door opening solutions



D83801401 Operator, RH, Rebuilt



D83801402 Operator, LH, Rebuilt



D84585400 Control, Single/Dual, Rebuilt



D85435400 Control, Single/Dual, Rebuilt



D87380900 Switch, 4 Position, Keyed



Remember - search for all parts online at www.besam-usa.com

© ASSA ABLOY Entrance Systems US Inc.

DOR-O-MATIC

ASSA ABLOY

BENCHMARK & ASCENT

The global leader in
door opening solutions



D95100-400R Operator,
Benchmark, Rebuilt



D95300400 Operator, Ascent,
Rebuilt

Obsolete



D99025-400 Control,
Benchmark



DOR-O-MATIC

ASSA ABLOY

MISC.

The global leader in door opening solutions



D4204107298 Switch, Rocker



D81895900 Switch, Rocker, ON/Off/Hold, Open

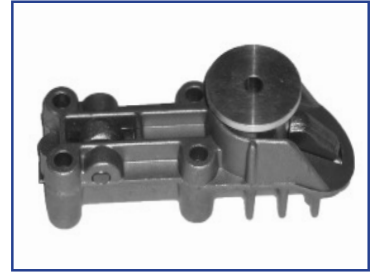

D1014000 Pivot, Bottom, Door Portion

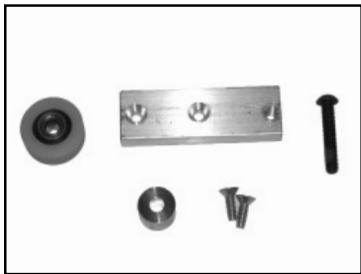

D65210900 Roller, Top Leading Edge

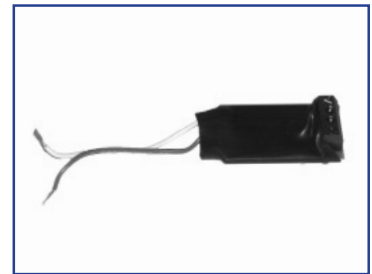

DOMBDYGRDIFB Board, Interface, Bodyguard



Remember - search for all parts online at www.besam-usa.com

© ASSA ABLOY Entrance Systems US Inc.

TABLE OF CONTENTS

The global leader in
door opening solutions

Dorma

Slide

- ESA - Belt Drive

Swing

- ED400 - High Energy
- ED700 - High/Low Energy

DORMA

ASSA ABLOY

ESA

The global leader in door opening solutions



DRDX489400 Control, Rebuilt



DRDS0649000 Motor, Slider, Rebuilt



DRDS0620010 Switch Plate



DRD0139010 Guide, Bottom, LH - replaced by **DRDS0704010**



DRDS0704020 Guide, Bottom, RH



DRDS0901010 Guide, Bottom, LH/RH



DRDS0650010 Roller, Carrier, Slider



DRDS0651000 Anti-riser, Slider



Add:

DRDS0650010 - Top rollers

DRDC3558010 - Tele. Idler Pulley

DR0234010 - Track Cap

ED400

The global leader in
door opening solutions



DRDS2625010 Control, New



DRDS2625R Control, Rebuilt



DREDA400RH Operator, RH,
Rebuilt , Handicap, OHC



DRDS2626010R Operator,
LH, Rebuilt (Shown)



DRDS2627010R Operator,
RH, Rebuilt



Remember - search for all parts online at www.besam-usa.com

© ASSA ABLOY Entrance Systems US Inc.

ED700

The global leader in
door opening solutions

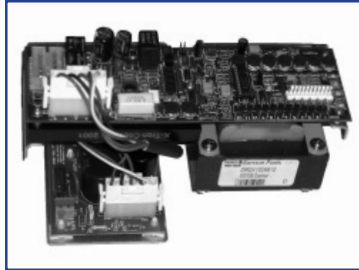

DRDX1029S10 Control, Analog
Rebuilt, O/S



DRED700 Operator, LH, Re-
built - Old Style



DRED700RH Operator, RH,
Rebuilt - Old Style



DRDS3105010R Control,
Digital N/S Rebuilt



Add to ESA II:

DRDS2814010 - ESA II Control

DRDS2815010 - ESA II Motor/Grbx

Add to ESA:

DRDE019503A - Bttm Trk FBO -CL

DRDE019503B - " " " -DB

DRDE020901A - Bttm Trk FBO Recess - CL

DRDE020901B - " " " " - DB

DRDE019001A - Threshold 1/8" x 3-1/4" - CL

DRDE019001B - " " " " - DB

TABLE OF CONTENTS

The global leader in
door opening solutions

Gildor

- SLM - Slide - Belt Drive

GILDOR

ASSA ABLOY

SLM

The global leader in
door opening solutions



GL160001R Motor, w/Motor Board, 110V, Rebuilt

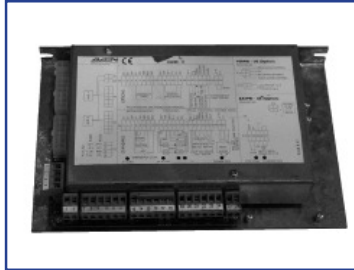

GL160002R Control, Slider, Rebuilt



GL190005 Roller, Hanger, Top



GL260001 Control Pad, Bedis

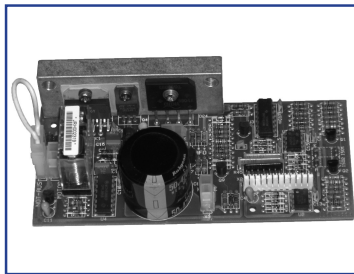

GL160030 Motor/Card Only, Old Style, Rebuilt



TABLE OF CONTENTS

Nabco

Slide

- 1100 - Whisperslide - Belt Drive
- 1175 - Belt Drive

Swing

- Swing-GT - High/Low Energy
- Gemini - Low Energy

Misc.



G413800 Control, POPC, Slider & Whisperslide, New



G413800RB Control, POPC, Slider & Whisperslide, Rebuilt

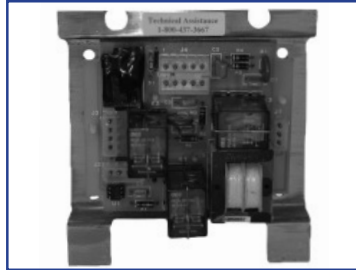

G218133 Control, w/Slide, Auxiliary Check Switches, Rebuilt

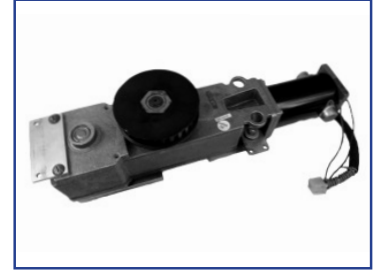

G414374 Gearbox/Motor, P.O.P.C. 100, Rebuilt



G410026R Gearbox/Motor, P.O.S.C., Rebuilt



G418054 Gearbox/Motor, POPC, Whisperslide, Rebuilt



G220575A Motor, Whisper-slide, SQ, 1360 RPM, Rebuilt



G220575RB Motor, Operator 1555 RPM, Rebuilt



G228625 Gearbox, POPC, Whisperslide, Rebuilt



G218065 Idler, Whisperslide



G410024R Operator, Swing POSC RH, Rebuilt



G410025R Operator, Swing POSC LH, Rebuilt





G241687 Belt, Clip Tooth Portion, 1 1/2"

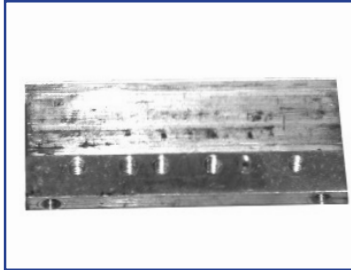

G241688 Belt, Clip Tooth Portion, 3"



G112071 Capacitor, Soft Start, Slider

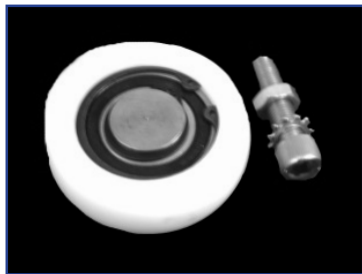

G218049 Roller, Anti-riser



G128327 Switch, Check, Magnetic Read, Whisperslide1



G218353 Switch, Panic, FSL, Whisperslide



G248179 Track, Bottom Guide, FBO, 52", Whisperslide



G128427 Guide, Bottom, Full Open



G214261 Guide, Bottom, FSL, RH



G214262 Guide, Bottom, FSL, LH



Remember - search for all parts online at www.besam-usa.com

© ASSA ABLOY Entrance System US Inc.

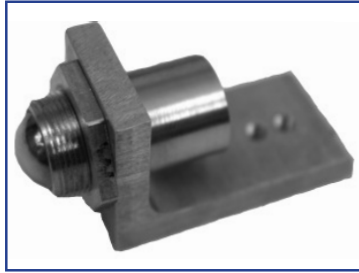

G129082 Ball Catch, Slider



G213468 Latch, Panic, Door Portion, Slider

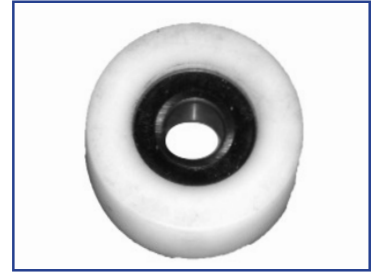

G220545 Roller, Anti-rise, Cover & Bearing



G118051 Switch, Proximity



G218831 Track, Roller





G148903 Programmer, Handy Terminal, Rental Only (2 week)



G248901.00 Control, Microprocessor, Swing/Slide, Rebuilt



G248901.30 Rev U30, Rebuilt



G219528 Gearbox/Motor, Whisperslide, Rebuilt



G219043 Roller, Hanger, Whisperslide



G119037 Roller, Anti-rise, w/Axle



G219053 Guide, Bottom, FBO, Whisperslide



G149045 Roller, Bottom Guide, FSL, Whisperslide



G219206 Motor, w/RC, Whisperslide, Rebuilt



G219530 Gearbox, Whisperslide, Rebuilt



Remember - search for all parts online at www.besam-usa.com

© ASSA ABLOY Entrance System US Inc.



G2190461 Guide Bottom, FSL, RH (was G219249)



G2190462 Guide, Bottom, FSL, LH (was G219250)



G219821-01 Switch, Door Position



G119903 Pulley, Idler, Slider

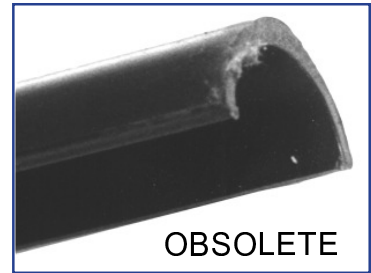

G149463 Track, Cap

OBSOLETE



G149057 Interlocker, Whisper-glide



G213468 Latch, Panic, Door Portion, Slider



G149016-01 Track, Threshold, GT1175

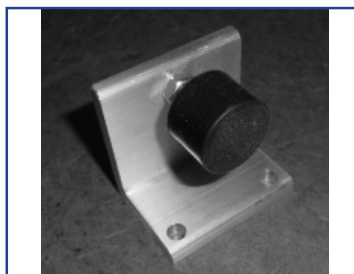

G149079 Full Open Stop Ass'y.

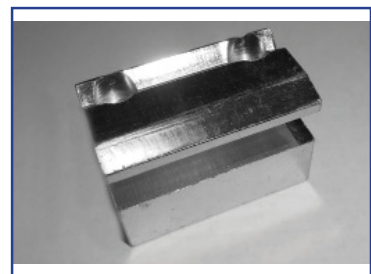

G242447 Latch, Panic, Carriage Portion



SWING

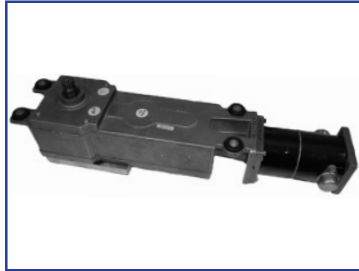

G410024R Operator, POSC, RH, Rebuilt



G410025R Operator, POSC, LH, Rebuilt



G41898701 Operator, Swing, LH, Rebuilt



G41898702 Operator, Swing, RH, Rebuilt



G111532 Stop, Ring, Full Open, CU



G220574RB Motor, Slide, Operator 209, 5 RPM, Rebuilt



G220575A Motor, Whisper-slide, SQ, 1360 RPM, Rebuilt



G220575RB Motor, Operator 1555 RPM, Rebuilt



G210709 Mount, Operator to Header



G411512 Control, POSC, Swing, Rebuilt



G412208 Control, GT500, Slow Mode, H/C, Rebuilt



G11093001 Panic Latch - 300 OHC



Remember - search for all parts online at www.besam-usa.com

© ASSA ABLOY Entrance System US Inc.

SWING

The global leader in door opening solutions



G243425 Relay, Time Delay

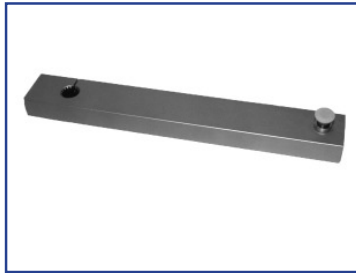

G210907 Arm, OHC, Inswing/Outswing, CL

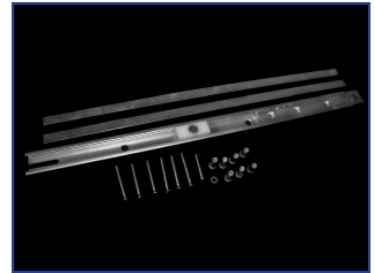

G210925 Track, Slide, Block

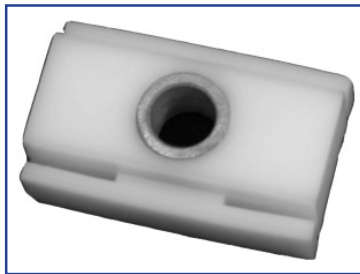

G215371 Block, Nylon, Slide, OHC

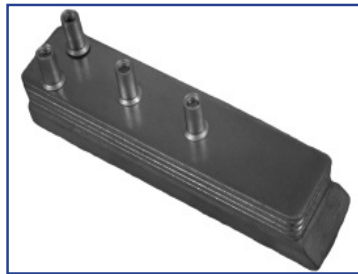

G210098 Pivot, Bottom, Door Portion



G210750 Pivot, Top, Retractable



G210926 Pivot, Bottom, Floor Portion

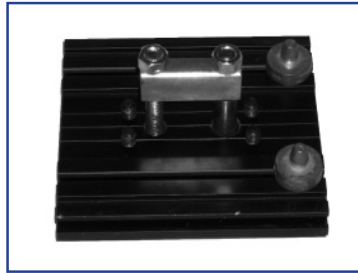

G211594 Pivot, Top, Retractable, Header



G240029 Pivot, Self Aligning, Race



SWING

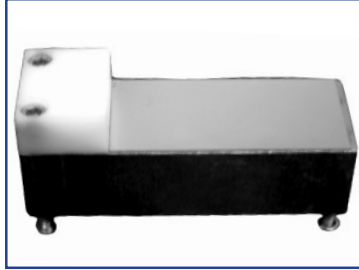

G210741 Stop, Door, OHC,
Outswing



GEMINI



G415638BL Operator,
Magnum 710, LH, Rebuilt



G415638BR Operator,
Magnum 710, RH, Rebuilt

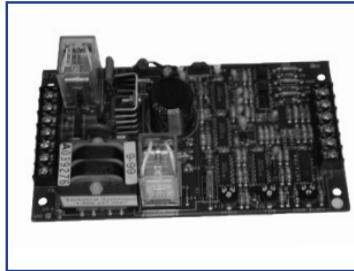

G218735 Control, Rebuilt

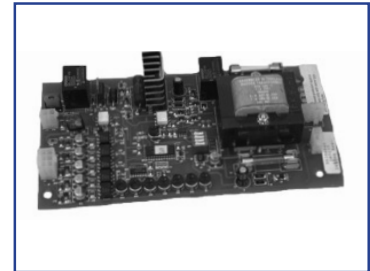

G249800 Control, Magnum
Force 720, Rebuilt



G24980001R Control, Magnum
Force 720, Version 1, Rebuilt



G24980002R Control, Magnum
Force 720, Version 2, Rebuilt



G24980004R Control, Magnum
Force 720, Version 4, Rebuilt



OTHER



G11094101 Switch, Panic,
PB-86, CL



G11094102 Switch, Panic,
PB-86, BZ



G210923 Arm, OHC, Inswing/
Outswing (specify), BZ



G24124702 Bolt, Shoulder,
for Arm 210923

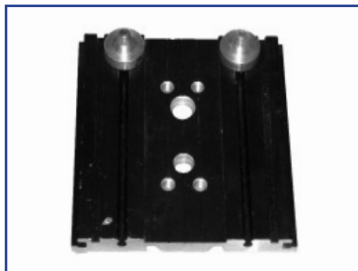

G22147401 Pivot, Base, CL



G111935 Roller for GT Swing
(InSwing roller for top track)



G112067 Capacitor, Soft
Start, POSC Swing



G128747 Roller, Bottom
Guide



G142137 Relay, Control
(safety or active), Large



G1A484 Relay, 12 VDC, Coil,
8 Pin, OCT, BAS



Remember - search for all parts online at www.besam-usa.com

© ASSA ABLOY Entrance System US Inc.

OTHER



G240952 Relay, Control Motor, Protector



G142313 Brush, Motor, RAE

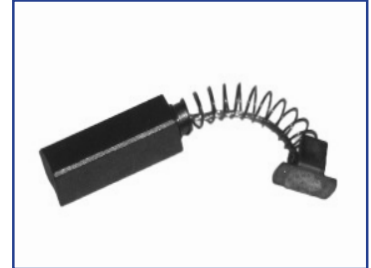

G143827 Brush, Motor, MET HELWIG, Carbon



G220516 Roller, Hanger, Cover & Bearing



G222066 Harness, Capacitor, Soft Start



G240744 Screw, Door to Arm, Slider, 3/8"



TABLE OF CONTENTS

Horton

Slide

- 2000 - Linear Drive
- 2000 - Industrial Belt Drive
- 2003 - Belt Drive
- Slider Hardware

Swing

- 4000 - Hercules
- 7000 - A.D.A.

Bi-fold

- 7600

Swing Door Hardware

Drive-thru Slider

- 8000

Revolver

Misc.

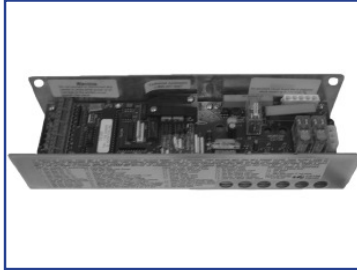

H21501R Control, Linear Drive, Rebuilt



H2150UR Control, Universal V10, Rebuilt



H21602RB Control, Slider, Open Chassis, Rebuilt

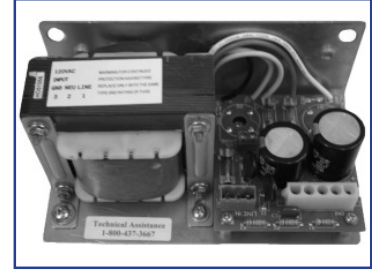

H3955 Power Supply, Slider, Linear, 2150/Control, Rebuilt



H2100R Motor, Slider, Litton, Rebuilt. Note: 1/2" motor to 1/2" coupling



H21002 Motor, Slider, Litton, Rebuilt, Old Style



H4011 Motor, Hercules, Swing, Dunker, Rebuilt. Note: 12MM motor to 1/2" coupling



H21382 Circuit Breaker, 1.5 Amp, w/Harness



H2110 Circuit Breaker, 1.5 Amp



H21554 Harness, Switch





H21552 Cable, Control to
Microswitch



HC21551 Lace, Operator,
(Pre-1/83)

**Replaced by H21554
See Pg. 1**

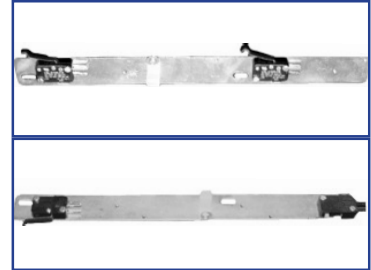

H21081 Switch, Back Check,
Open Cut-off (Top)



H21091 Switch, Latch Check,
Open Closed-off (Bottom)



HC21202 Switch, Check &
Cut-off



H21061 Switch, Micro



H21765 Lock, Electric, Fail
Secure, 2150/Linear, New



H21965 Lock, Electric, Fail
Safe, 2150/Linear, New

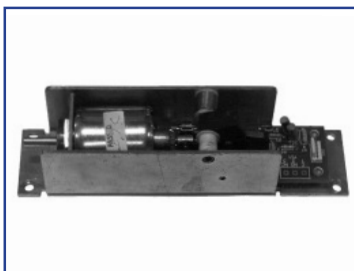

HC38760 Autolock, (Only),
Fail Secure, for 2150

Replaced by H21765



H21962 Autolock, Electric,
Fail Safe, for 2160



Remember - search for all parts online at www.besam-usa.com

© ASSA ABLOY Entrance Systems US Inc.

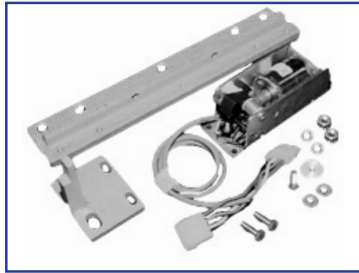

H21762 Lock, Electric, Fail Safe, (2160/Linear), New

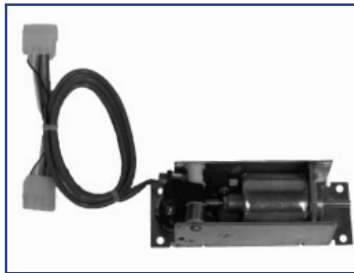

HC21772 Autolock, (Only), Fail Secure, Rebuilt, for 2160

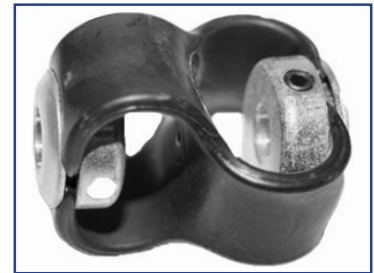

H21011 Coupling, Motor, Dunker, Slider, 1/2" x 12mm



H21012 Coupling, Slider, 1/2" x 1/2"



H21172 Bracket, for Motor & Bearing



H2148 Bearing, Drive Rod



HC22480 Collar Lock for C2148



H2152 Collar, Locking



H2103 Drive Shaft, 1/2" Steel



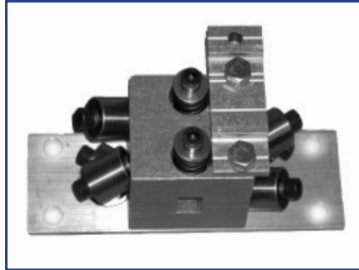

H21022 Block, Linear Drive,
Bi-part, Slider

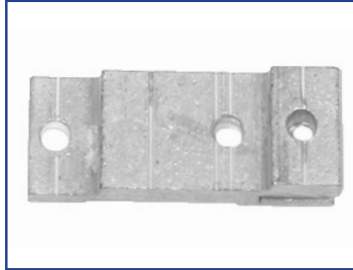

H21341 Clamp, Cable
used on HC21022



H2126 Bearing, Linear Drive,
(each)



H21432 Bracket, End of Drive
Shaft



H21311 Bushing, Drive Rod
Idler

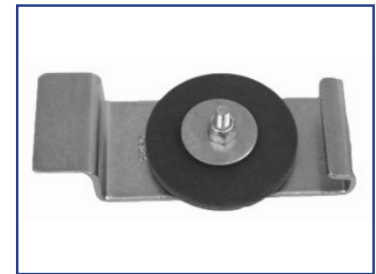

H21361 Pulley, Idler, Each End



H0467A Cable, Slider, Complete



H2249 Clamp, Cable, Slave
Side



Remember - search for all parts online at www.besam-usa.com

© ASSA ABLOY Entrance Systems US Inc.



HC21351 Bracket, Co-Active Slave

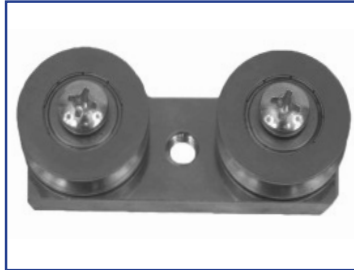

H817 Idler, Wheel, Slider, sx Type

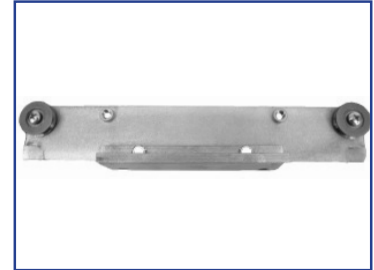

H21301 Hanger, Roller & Bracket



H0815 Wheel, Carriage, (o-sx)



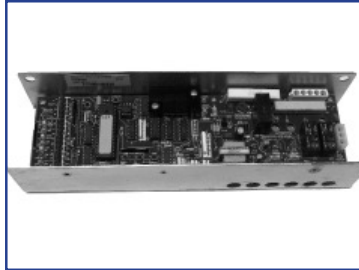

H21502R Control, Belt Drive, Rebuilt

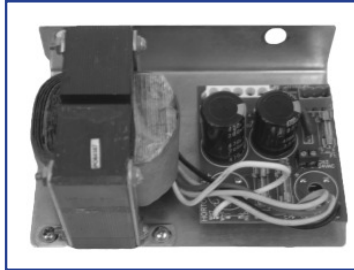

H3925 Power Supply, 2150/Drive Belt, Rebuilt
Obsolete - Use H3955

H3955 Power, Supply 2150 Ctrl Sldr-Rebuilt

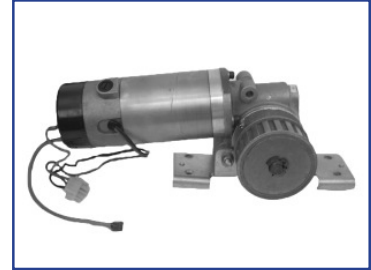

HC36751R Gearbox/Motor, 1/8 HP, Rebuilt, 6-7/8" long motor



HC36761R Gearbox/Motor, 1/4 HP, Rebuilt

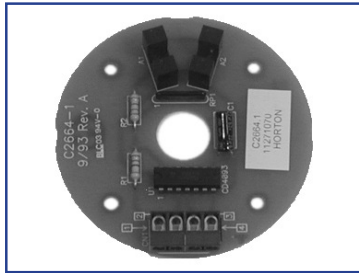

HC26641 Encoder, Slider



H3976 Autolock, Fail Secure, New



HC3976R AutoLock, Fail Secure, Rebuilt

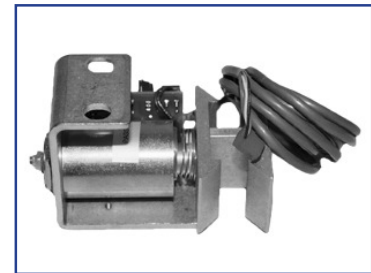

HC39770 AutoLock, Fail Safe, New



HC3977R AutoLock, Fail Safe, Rebuilt

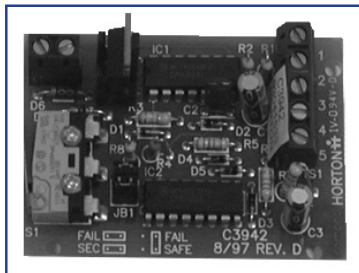

HC39420 Circuit Board for Auto Locks, New

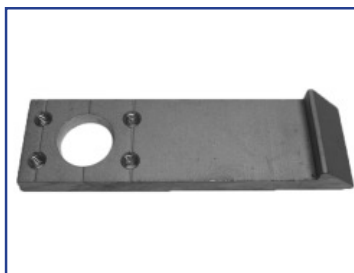

HC3789 Keeper, Lock Strike, Slider

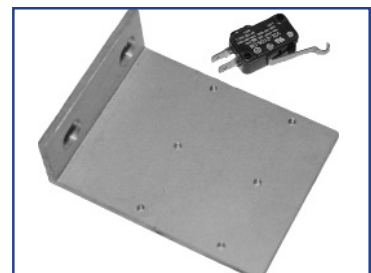

HC37331 Switch, Closed Monitor



Remember - search for all parts online at www.besam-usa.com

© ASSA ABLOY Entrance Systems US Inc.



HC35770 Pulley, Idler



USLH100US Drive Belt,
Slider, 1", Black

Replaced by H2658



H2658 Belt, Slider, 1",
Reinforced (2150)



HC26782 Plate, Belt Splice



H3636 Roller, Hanger,
Belt Drive, (2001/2003)

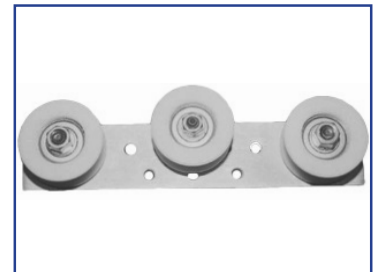

HC36811 Roller & Carriage

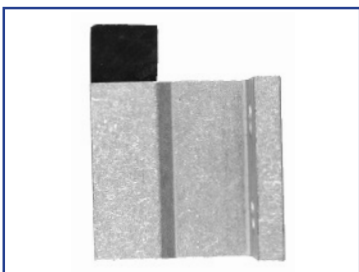

HC36720 Bumper



H36752 Gearbox/Motor,
1/8 HP, Dunker RB



H36754 Gearbox/Motor,
1/8 HP, Dunker -New



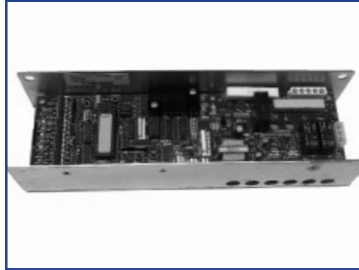

H21502R Control, Belt Drive, Rebuilt



H56002 Gearbox/Motor, Dunker, Slider, New



H56001R Gearbox/Motor, Dunker, Slider, Rebuilt



H5600 Gearbox/Gearbox w/Encoder, Litton, Rebuilt



H5656 AutoLock, Fail Secure, New



H5656KB AutoLock Kit, Fail Secure, New



H5657 AutoLock, Fail Safe, New



H5657KB AutoLock Kit, Fail Safe, New

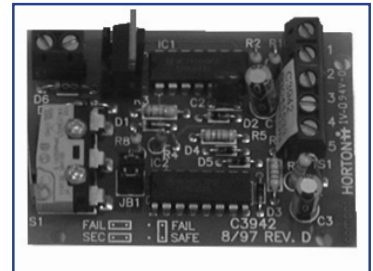

HC39420 Circuit Board for Auto Locks



HC56620 Switch, Rocker, On/Off



HC56210 Pulley Drive



HC5623 Bracket, Belt Pulley



Remember - search for all parts online at www.besam-usa.com

© ASSA ABLOY Entrance Systems US Inc.



HC56250 Pulley Wheel Only



HC56300 Belt Clamp

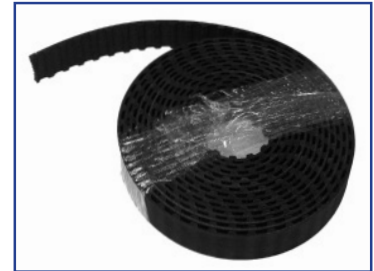

USLO75 Drive Belt, Slider,
3/4", Black

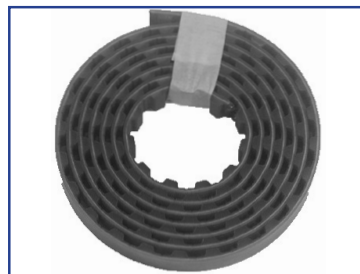

H5639 Drive Belt, Slider, 3/4",
Green



H3636 Roller, Hanger, Belt
Drive (2001/2003)

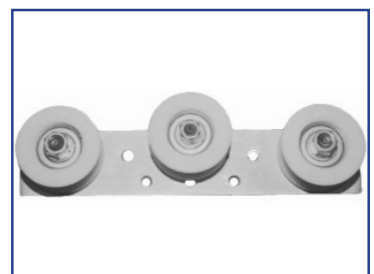

H36811 Roller & Carriage

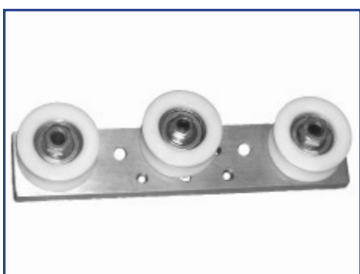

HC36810 Wheel, Idler

Replaced by H36811



H0801 Ball Catch, w/Spring,
Slider



H08051 Ballcatch, Panic,
Latch, Slider



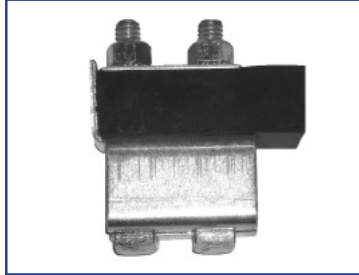

H5636 Bumper Assembly, 2 1/4"



HC56380 Switch, Close
Monitor





HC37260 Switch, Double, Rotary



H37251 Switch, 4 Position Key, White Faceplate

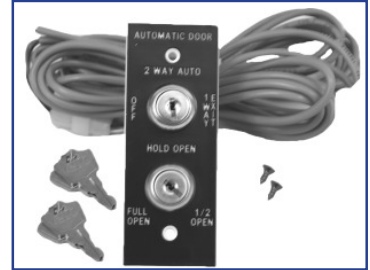

HC37250 Switch, Double Key

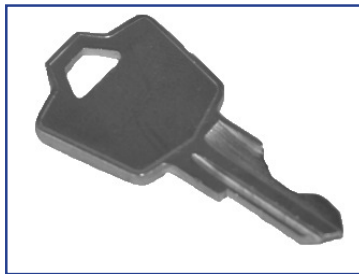

HCA126 Key (only)



HCK2R Beam, C & K, Rebuilt



H1141 Switch, Magnetic Breakout, Slider



HC04441 Magnet, SO/CO, (C114-1)



H09021 Switch, Panic, Assembly, w/Bracket, SX

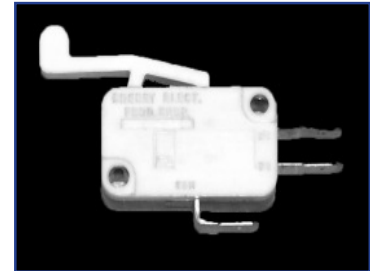

H8951 Microswitch, Cherry, E2290NO



HARDWARE SLIDING DOOR

The global leader in
door opening solutions

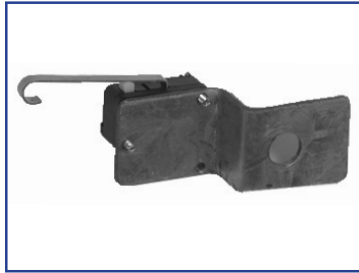

HC39930 Switch, Close Monitor



H2240 Harness, Slider
Obsolete

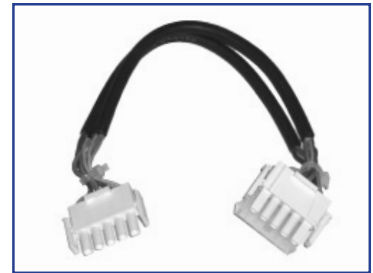

H4192 Harness, "Y" Split Power Cord



H4196 Lace Synchronization Cable



H08431 Guide, Bottom, FSL, Pin Type, RH



H08441 Guide, Bottom, FSL, Pin Type, LH (SHOWN)



HC08432A Guide, Bottom, CGL, RH (RH Shown)



HC08442A Guide, Bottom, CGL, LH

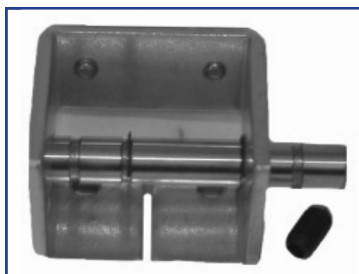

H08522 Bracket, Bottom Guide, Slider



H08881B Interlock, Security, SX, Slider, BK (BK Shown)



H08881 Interlock, Security, SX, Slider, CL

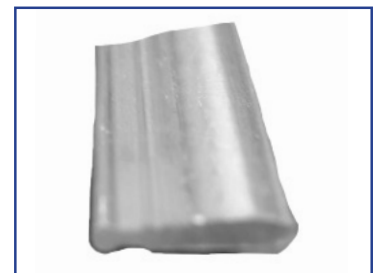

H03801 Track, Heavy Duty, 8', CL



Remember - search for all parts online at www.besam-usa.com

© ASSA ABLOY Entrance Systems US Inc.

HORTON

HARDWARE SLIDING DOOR

ASSA ABLOY

The global leader in
door opening solutions

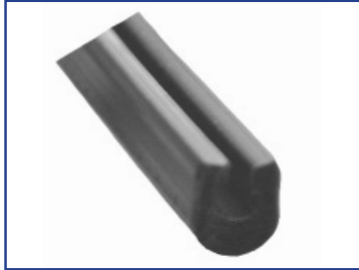

H02911 Track, Cap, Hanger, Roller, (New Style)

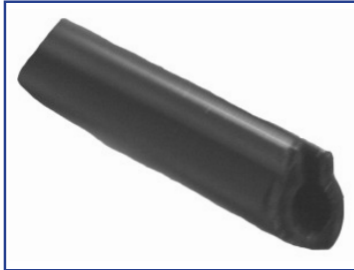

H0291R Track, Cap, Hanger, Roller, (Old Style)

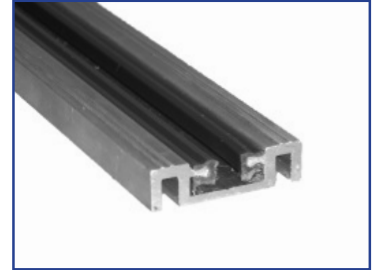

H0367A Track, Bottom Guide, w/Cap, CL (CL Shown)

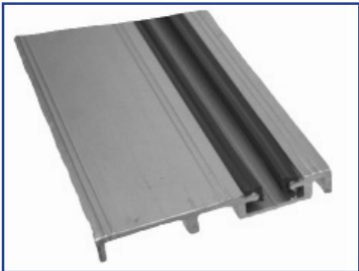

HC2873 Track, FBO, Bottom Guide, 4", w/Cap, CL



H2873B Track, FBO, Bottom Guide, 4", w/Cap, DB



H03301A Track, Bottom, 2" Tall, FSL, CL (CL Shown)



H03301B Track, Bottom, 2" Tall, FSL, DB



H0289 Track, Cap, Bottom Guide, Slider

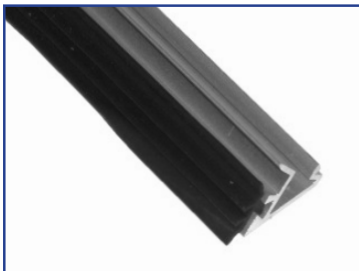

H369RA Glass Stop, Beveled, 1/4", CL

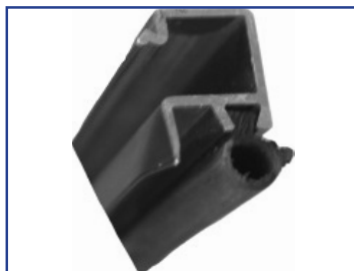

H0338B Glass Stop, 1/4" Square, w/Vinyl, DB



H0338RA Glass Stop, 1/4" Square, w/Vinyl, CL



phone: 888-732-3726

parts.na.besam@assaabloy.com

fax: 800-304-9459

© ASSA ABLOY Entrance Systems US Inc.

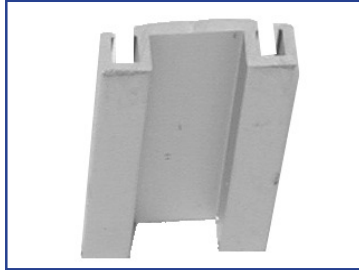

H0358A ASTRAGAL, ADJ.
w/C350, CL (shown)



H0358B ASTRAGAL, ADJ.
w/C350, DB

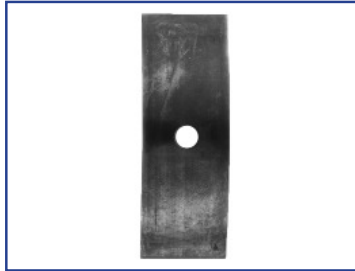

HC06720 Spring, ADJ,
Astragal

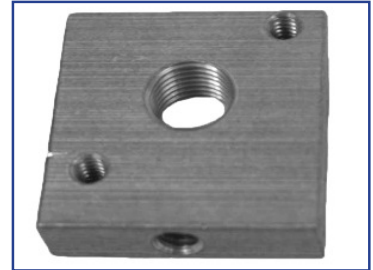

H55511 Block, Bottom Pivot

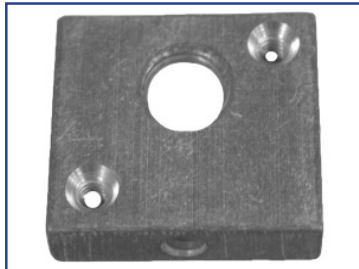

H55512 Block, Bottom Pivot,
Base



HC55521 Pin, Bottom Pivot

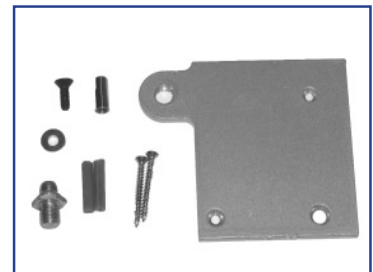

HC9811 Pivot, Bottom,
Outswing for S310



H8701 Guide, Bottom, FBO,
1 Pin Type



H903 Pin, Guide, 1/2" Long
from Bottom Guide



HC0964B Guide, Bottom for
X-Panel



Remember - search for all parts online at www.besam-usa.com

© ASSA ABLOY Entrance Systems US Inc.

HARDWARE SLIDING DOOR

The global leader in
door opening solutions

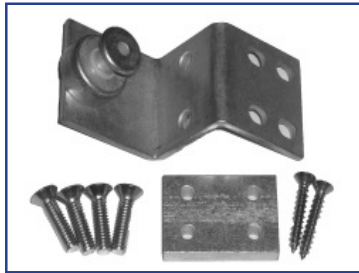

HC0980A Guide, Bottom, SX,
S310



HC6291A Guide, Bottom,
Telescope, "X", CL

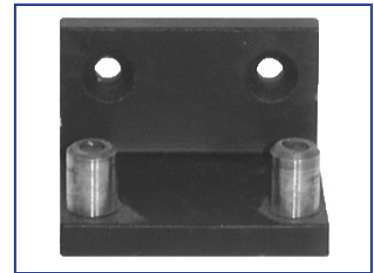

HC6291B Guide, Bottom,
Telescope, "X", BK

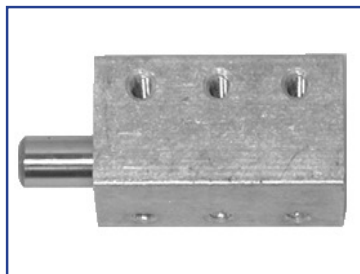

H05901 Pivot, Block, Door,
Outswing

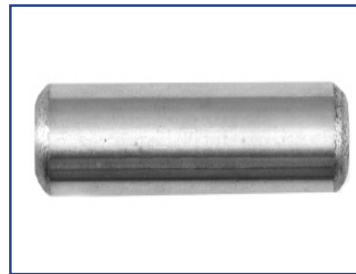

HC05911 Pin, Pivot,
Outswing, Top Door



HC0593 Pivot, Bushing



H03891 Interlock, Vertical,
Mohair

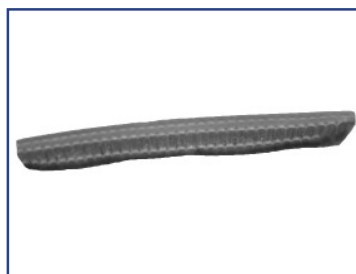

H350 Weatherstripping, Nosing

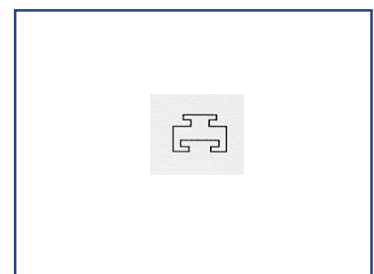

H397 Adapter, Vinyl, Vertical,
Mohair, BK



HARDWARE SLIDING DOOR

The global leader in
door opening solutions

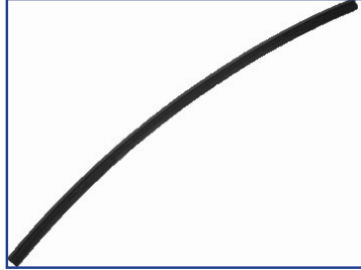

H3411 Weatherstripping
for Clean Room



HC04540 Lock, Security,
Hook Type,



HC0457A Lock, Face Plate
w/Mohair, CL



HC0457B Lock, Face Plate
w/Mohair, DB

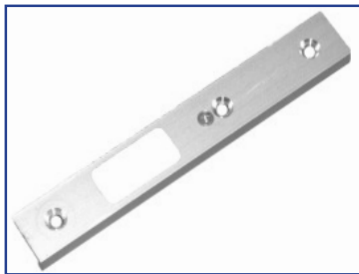

HC0459A Lock, Keeper Plate, CL



HC0459B Lock, Keeper Plate, DB



HC23170 Lock, Rail Bottom

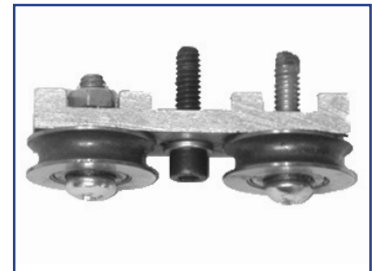

H0407 Wheel, Carriage, (x-o),



H0409 Wheel, Carriage, Idler



H0589 Pin, Outswing, Pivot
(manual)



H0816 Wheel, Carriage, (sx-o)



Remember - search for all parts online at www.besam-usa.com

© ASSA ABLOY Entrance Systems US Inc.

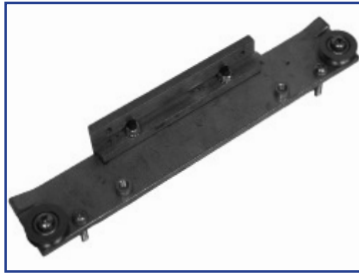

H21371 Wheel, Carriage,
sx Type



HC04251 Wheel, PK Manual,
X-Panel

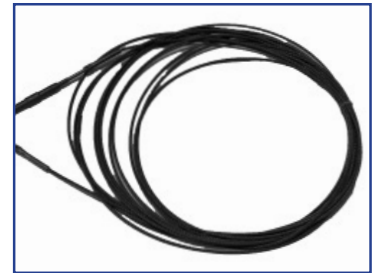

HC46714 Cable, Co-active,
14 Ft.



H1033 Regulator, Air Pressure,
Pneumatic



4000

The global leader in door opening solutions



H4160RB Control, Swing (old style), Rebuilt

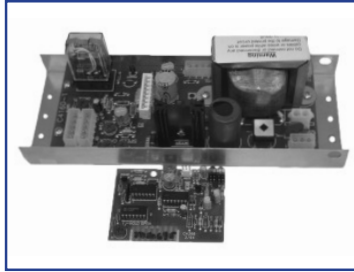

H41601RB Control, Swing w/Lead, Hercules, Rebuilt



H41601 Control, Swing w/Lead, Hercules, New

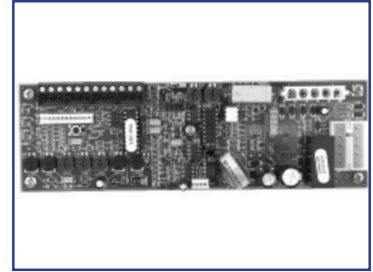

HC41602R Control, Slave, Rebuilt

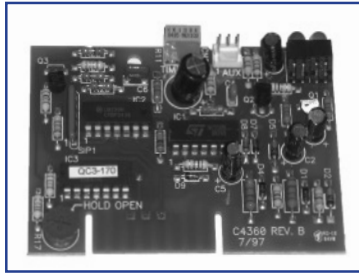

HC43600 Timer Control, DAU, for C4160

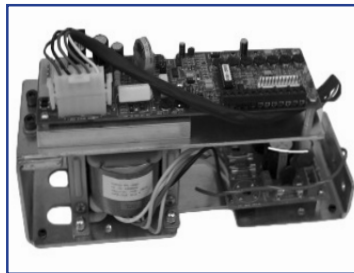

HC4190BLRB Control, Bottom Load, (4000/7000), Rebuilt

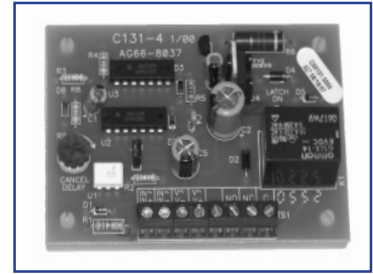

HC01314 Control Latch, Relay, All

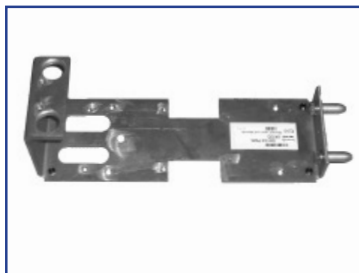

H4120 Bracket, Operator Mounting, Hercules

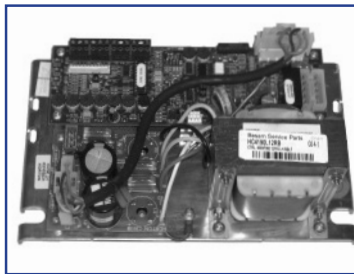

HC4190L12RB Control, 12 Pin, LH, (4000/7000), Rebuilt- SHOWN



HC4190R12RB Control, 12 Pin, RH, (4000/7000), Rebuilt

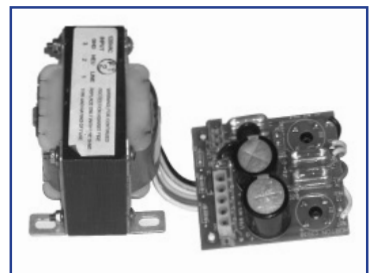

HC41330 Power Supply for C4190, New



Remember - search for all parts online at www.besam-usa.com

© ASSA ABLOY Entrance Systems US Inc.



H3959 Harness for C4190 Power Supply, Slider, 12"



HC39594 Harness for C4190 Power Supply, 48"



HC4100L14RB Operator, 14 Tooth, LH, Hercules, Rebuilt



HC4100R14RB Operator, 14 Tooth, RH, Hercules, Rebuilt



HC4100R48RB Operator, 48 Tooth, RH, Hercules, Rebuilt



HC4100L48RB Operator, 48 Tooth, LH, Hercules, Rebuilt



H4011 Motor, Hercules, Swing, Dunker, Rebuilt

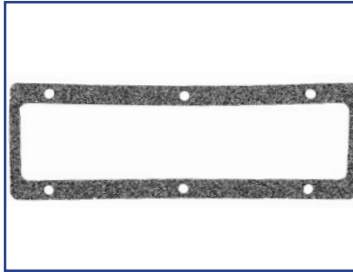

HC40360 Gasket, Side Cover



HC40511 Spring, Closing



H41561 Harness, w/Close, Sp. Control, Hercules



H4155 Circuit Breaker, 1.25 Amp, w/Harness



H4110 Circuit Breaker, 1.25 Amp





HC40242 Cam, Check Switch

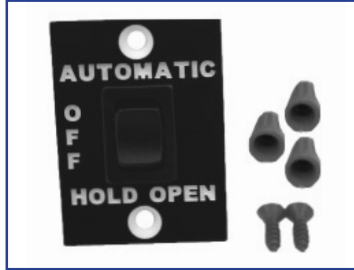

HC43201 Switch, Rocker,
w/Diode, Auto/Off/Hold



HC3069 Bushing, Rubber

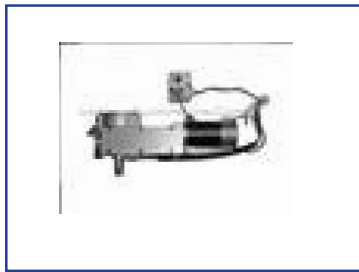

HC4200L14R Operator, Bi-Fold,
LH, 14T, Rebuild



HC424114A Arm, InSwing,
Parallel, 14T, Clear



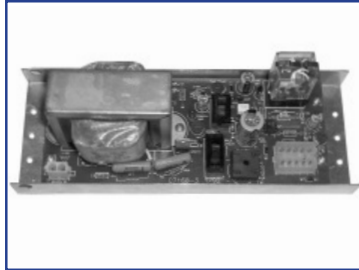

H71603 Control, Handicap, Rebuilt

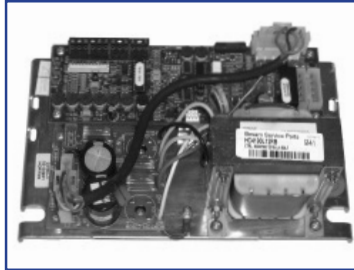

HC4190L12RB Control, 12 Pin, LH, (4000/7000), Rebuilt

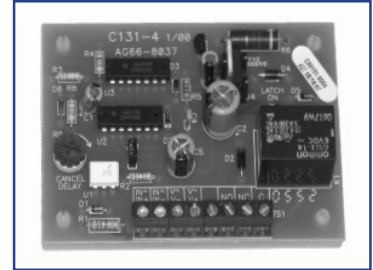

HC01314 Control Latch, Relay, All

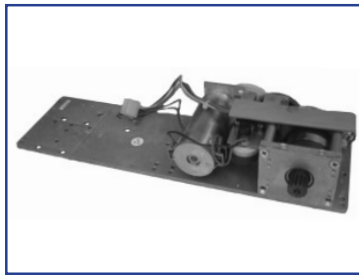

HC7100LI14RB Operator, LH, Inswing, 14 Tooth, Rebuilt



HC7100RI14RB Operator, RH, Inswing, 14 Tooth, Rebuilt



HC7100LO14RB Operator, LH, Outswing, 14 Tooth, Rebuilt



HC7100RO14RB Operator, RH, Outswing, 14 Tooth, Rebuilt

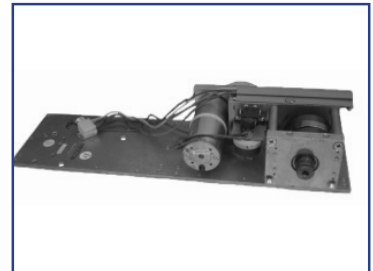

HC7100LI48RB Operator, LH, Inswing, 48 Tooth, Rebuilt



HC7100RI48RB Operator, RH, Inswing, 48 Tooth, Rebuilt

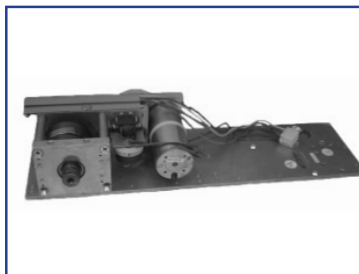

HC7100LO48RB Operator, LH, Outswing, 48 Tooth, Rebuilt



HC7100RO48RB Operator, RH, Outswing, 48 Tooth, Rebuilt

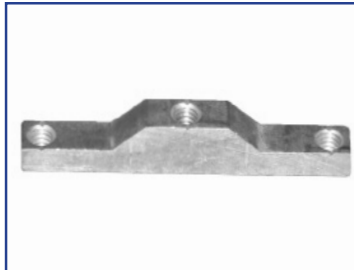

HC70371 Stop, Chassis Mount



H71151 Motor, Slider, Rebuilt





HC43200 Switch, Rocker



H7050 Closing Spring, "D",
(Standard)



HC70510 Closing Spring,
(Heavy Duty)



HC71550 Circuit Breaker,
Lace (Ref: 71603 Control)



H9110 Circuit Breaker,
0.8 Amp



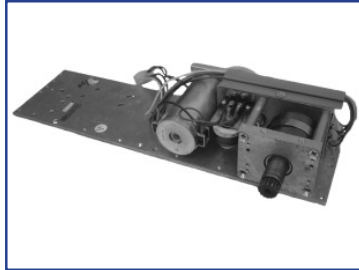

HC7600LI14 Operator, LH, Bi-fold, Inswing, 14 Tooth, Rebuilt



HC7600RI14RB Operator, RH, Bi-fold, Inswing, 14 Tooth, Rebuilt

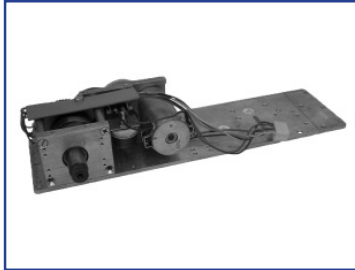

HC7600LO14RB Operator, LH, Bi-fold, Outswing, 14 Tooth, Rebuilt



HC7600RO14RB Operator, RH, Bi-fold, Outswing, 14 Tooth, Rebuilt

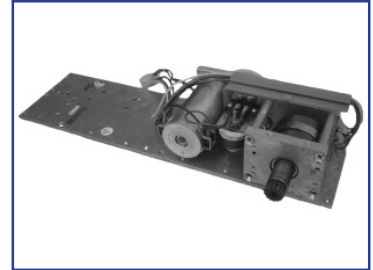

HC7600LI48RB Operator, LH, Bi-fold, Inswing, 48 Tooth, Rebuilt



HC7600RI48RB Operator, RH, Bi-fold, Inswing, 48 Tooth, Rebuilt

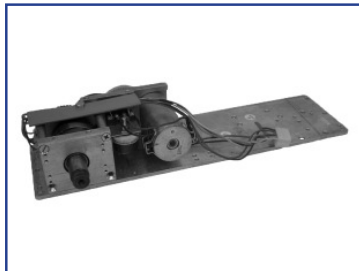

HC7600LO48RB Operator, LH, Bi-fold, Outswing, 48 Tooth, Rebuilt



HC7600RO48RB Operator, RH, Bi-fold, Outswing, 48 Tooth, Rebuilt

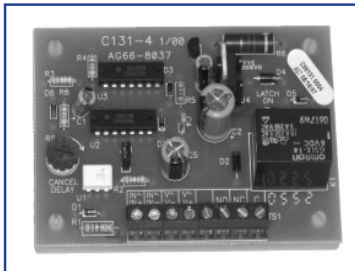

HC01314 Control Latch, Relay, All



H77021 Hinge Bi-fold, w/Screws, RH, Rebuilt (Shown)



H77001 Hinge Bi-fold, w/Screws, LH, Rebuilt



HC7685 Guide, Top Roller, Bifold



HC76861 Roller, Top Guide, 7/8", Bi-fold, New

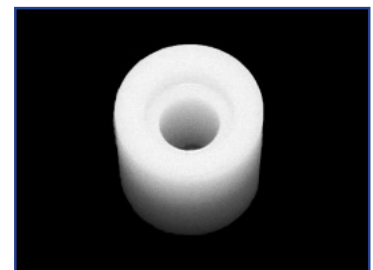

HC7686 Roller, Top Guide, 5/8", Bi-fold, (Old)



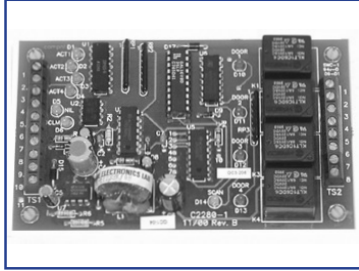

H2280 Module, 4 Door Interlock Control

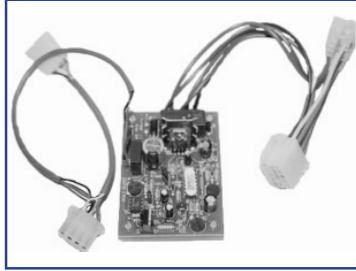

H4150 Module, Power Assist Close

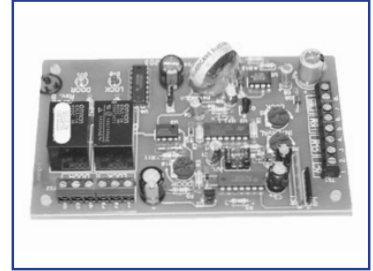

HC72201 Relay, Time delay, Strike Interface



H3930 Fuse, 1.5 Amp

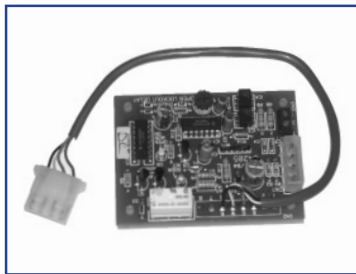

H4205 Relay, Lock-out



HC41967 Lace, Synchronization Cable



HC56700 Switch, Rocker, 3 Position



H21061 Switch, Micro



HC4527A Emergency Stop, w/CO, CL



Remember - search for all parts online at www.besam-usa.com

© ASSA ABLOY Entrance Systems US Inc.

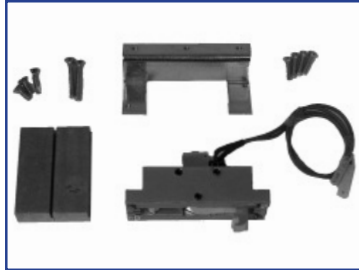

HC4529A Emergency Stop



H4197 Arm, OHC, 14 Tooth, DB



HC77341 Arm, Power Adjust., Overhead, 48 Tooth, Bi-fold

Replaced by **HC773948B**



HC773914A Arm, Top Pivot, 14 Tooth, CL



HC773914B Arm, Top Pivot, 14 Tooth, BK

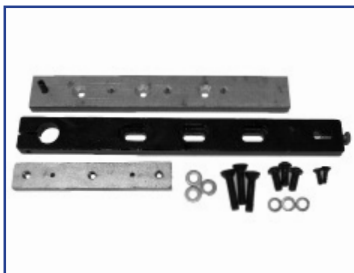

HC773948A Arm, Top Pivot, 48 Tooth, CL



HC773948B Arm, Top Pivot, 48 Tooth, BK



HC455114 Arm, 14 Tooth, Concealed, CL



HC455114B Arm, 14 Tooth, Concealed, DB

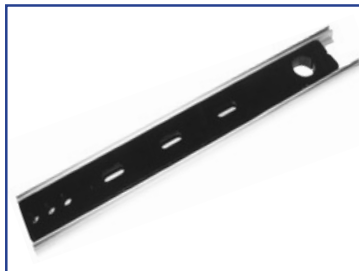

HC455148 Arm, Isolated, 48 Tooth, CL



H42411 Arm Track, Parallel, Inswing, 14 Tooth

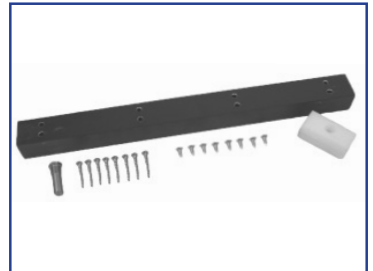

H4550 Arm, Top Track & Slide Block





HC424148A Arm, Parallel,
Track Assembly, 48 Tooth, CL



HC424148B Arm, Parallel,
Track Assembly, 48 Tooth, BK

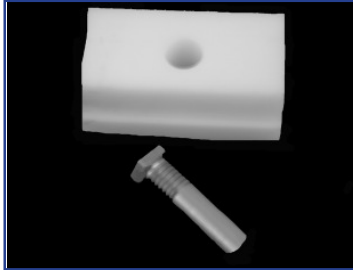

HC4556 Slide Block, w/Bolt,
OHC Arm



HC424814A Arm, Pull Surface,
Parallel, 14 Tooth, CL



HC424814B Arm, Pull Surface,
Parallel, 14 Tooth, DB



HC424848A Arm, Pull Surface,
Parallel, 48 Tooth, CL



HC424848B Arm, Pull Surface,
Parallel, 48 Tooth, DB



HC425014A Arm, Inswing,
Pull Surface, 14 Tooth, CL



HC425014B Arm, Inswing,
Pull Surface, 14 Tooth, DB



HC425048A Arm, Inswing,
Pull Surface, 48 Tooth, CL



HC425048B Arm, Inswing,
Pull Surface, 48 Tooth, DB



HC425214B Arm, Outswing, Push
Surface, Parallel, 14 Tooth, DB



HC425214A Arm, Outswing, Push
Surface, Parallel, 14 Tooth, CL



Remember - search for all parts online at www.besam-usa.com

© ASSA ABLOY Entrance Systems US Inc.



HC425248A Arm, Outswing, Push Surface, 48 Tooth, (H4252), CL



HC425248B Arm, Outswing, Push Surface, 48 Tooth, (H4252), DB



HC308014 Collar, 14 Tooth, (shown)



HC308048 Collar, 48 Tooth

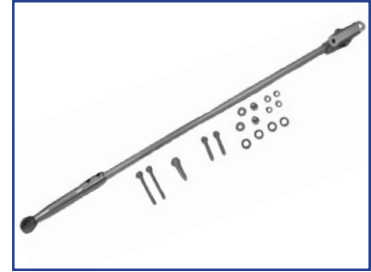

H52541 Arm, Connecting Rod

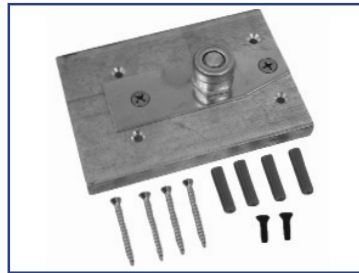

H7610 Pivot, Bottom Floor Portion

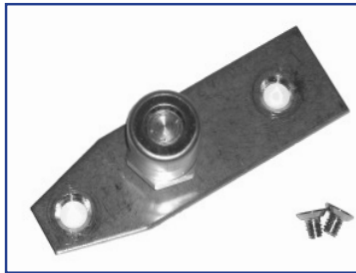

HC7614 Pivot, Bottom Floor, Swing/Bi-fold

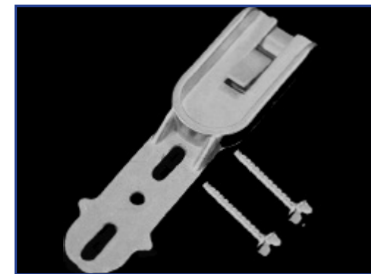

H7609 Pivot, Bottom Door Portion



H4548 Pivot, Top, Side Load Header Portion



H9538 Pivot, Top, Header Portion

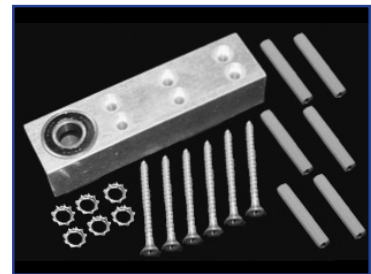

H9535 Pivot, Top Door Portion



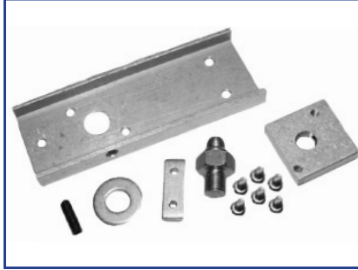

HC55421 Pivot, Bottom Floor Portion



HC3010G Adjustable Bottom Pivot, Floor Mount



HC3010GE Adjustable Bottom Pivot, Threshold Mount

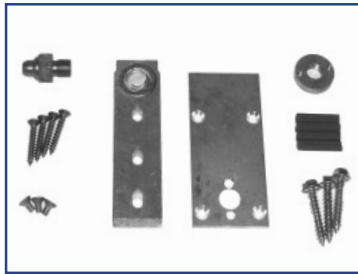

HC55950 Pivot, Bottom, No Threshold

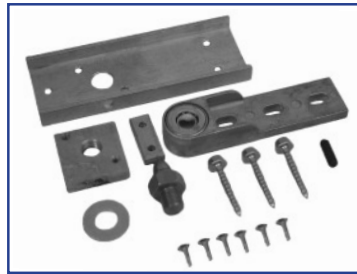

HC4542A Pivot, Bottom, w/Threshold Plate

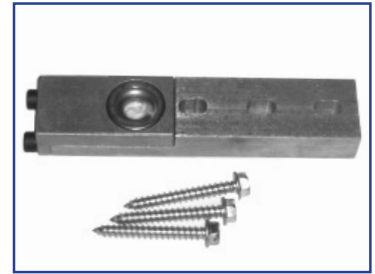

HC55412 Pivot, Bottom Assembly, Door Portion



HC95411 Pivot, Bottom Guide

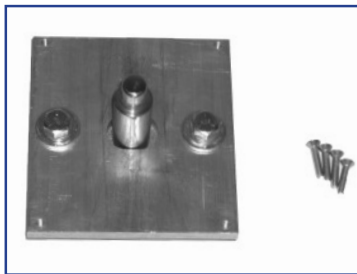

HC45380 Header, Isolated Pivot



HC55181A Stop, Door, CL



HC55181B Stop, Door, DB



Remember - search for all parts online at www.besam-usa.com

© ASSA ABLOY Entrance Systems US Inc.

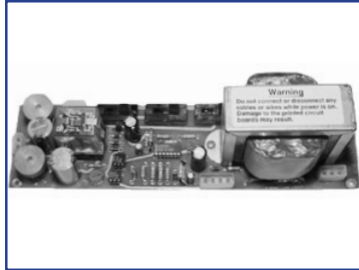

H81603 Control, Window, New



H81603RB Control, Window,
Rebuilt



H82071 Motor, Window, 60
VDC, 1200 RPM, 1/20 HP, New



H82072 Motor, Dunker, New



HC82092 Motor & Bracket,
New



HC82170 Adapter, Motor
Shaft, 1/4"



HC82220 Coupling, Motor
Shaft



HC82332 Block, Linear Travel



HC95580 Bearing, Wind
Travel, BK



H8258 Microswitch, v31206d8

Replaced by **USV3L131D8**



8000



HC82101 Bracket, Idler/ Motor,
for C2131-1



HC82131 Switch, w/Lace,
Motor Control



H8243 Circuit Breaker



HC83820 Lock, Body, Bipart

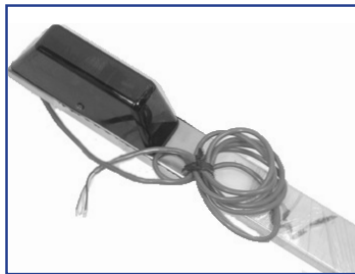

HC11605 Hip Scan, Rebuilt



H11694 Window, Scan Lens



HC8249 Guide, Bottom,
Window



Remember - search for all parts online at www.besam-usa.com

© ASSA ABLOY Entrance Systems US Inc.

REVOLVER

The global leader in
door opening solutions



HC93880 Switch, Magnetic, Read



HC98850 Switch, Rocker



H8940 Collector Ring



H9665 Bearing, Shaft



H96761 Post, Bottom Pivot



H97661 Ball Catch Bracket

Obsolete



H9451 Weatherstrip, Lead Edge, 2 1/2", (per ft.)



H9452 Weather Seal, Top, 1 1/2", (per ft.)

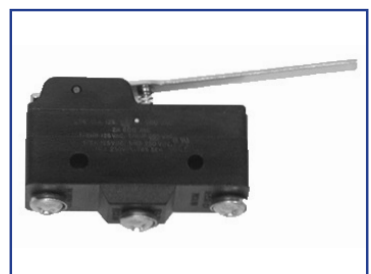

HC00300 Microswitch, w/o Bracket



MISC.



H37261 Switch, Rotary, Single Knob



HC05290 Switch, Key On/Off Maintenance



HC05300 Switch, Key On/Off Momentary

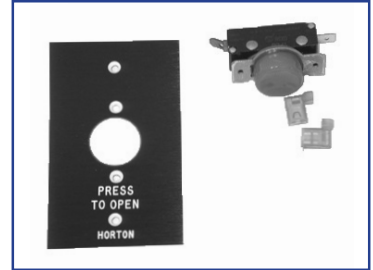

HC05200 Switch, Press to Open



HC05212 Switch, Handicap, Jamb Mount



HC21810 Microswitch, Long Arm, 2000 Series, DP Switch, 8000 Windows
Replaced by USV3L131D8



HC22510 Lace, Toggle Switch

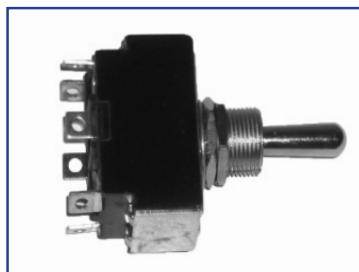

HC5119R Switch, Toggle, DPDT, 10 Amp



HC83400 Switch, Fly Fan



HC90260 Switch, Lace, On/Off Toggle



Remember - search for all parts online at www.besam-usa.com

© ASSA ABLOY Entrance Systems US Inc.

MISC.

The global leader in door opening solutions



HC39890 Wiring Harness



HC404012 Contact Magnet, 3/8", SPDT



HC41800 Power Cord, 120 VAC



HC6520 Keypad, Program-mable



HC90360 Splice, 4 Conductor



HC7280 Decal, Double-Sided, Auto Door



HC21802 Motor, Coupler, Linear, Dunker, New



HC56380 Switch Close Monitor



TABLE OF CONTENTS

Record

Slide

- 1100 - Belt Drive
- 7000 - Chain Drive

Add: 5100 - section

Swing

- 2000 - Hydraulic Drive
- 2500 and 4500 - Hydraulic Drive
- 3000 - Chain Drive
- 3500 - Chain Drive
- 3800 - Chain Drive

Add: 8100 - section

Misc.



N9999991311 Control, Slider, Rebuilt



N4110813 Gearbox/Motor, Slider, ZII, Rebuilt



N9999992124 Gearbox/Motor, Rebuilt



N9992154 Motor, KM w/RC, Rebuilt



System 19



N4110022 Idler, Pulley & Bracket



N9999994135 Pulley, Idler, Slider



N9999990008 Belt, Timing, Slider



N9110001 Track, Cap, FBO, (New Style)- was N9-11-0001



N997000077 Track, Cap, Bottom Guide, Old Style





N5114004 Track, Top
Extrusion, New Style



N5114008CL - Bttm Trk w/Vinyl



N4110469 Guide, Bottom,
FBO



N4110470 Guide, Bottom,
Slider, LH



N4110471 Guide, Bottom,
Slider, RH, (KM)



N09090010 Belt, Gearbox/
Motor, Large

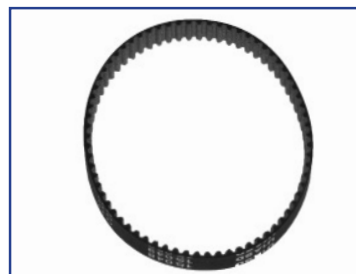

N09090011 Belt, Gearbox/
Motor, Slider



USDC0903690 Stop, Universal
- was N4110457



N4700582 Fixed Panel, Panic
Ball Only



RECORD / KM

ASSA ABLOY

7000

The global leader in
door opening solutions



N4470009100 Control,
w/Speed Toggle, Rebuilt

Obsolete



N4460000447 Gearbox,
w/Sprocket, Slider, LH, Rebuilt



N997000077 Track, Cap,
Bottom Guide, Old Style



N4470000083 Guide, Bottom,
FSL, RH

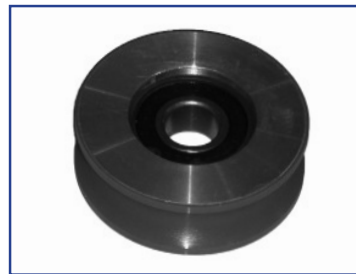

N4460001890 Roller, Hanger,
Slider, LH, (KM)



N4470000577 Anti-rise Kit,
Slider

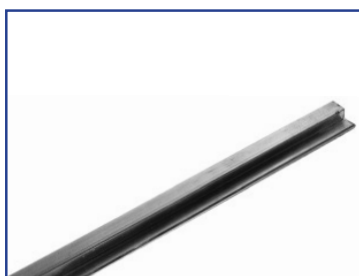

N5114004 Track, Top
Extrusion, New Style



phone: 888-732-3726

parts.na.besam@assaabloy.com

fax: 800-304-9459

© ASSA ABLOY Entrance Systems US Inc.

3 Rev C



NTM8LH Operator, TM8, LH, Rebuilt



NTM8RH Operator, TM8, RH, Rebuilt

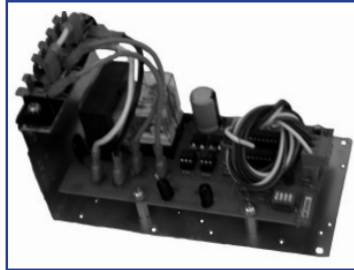

N4200102 Control, Swing "B", Hydraulic, Rebuilt

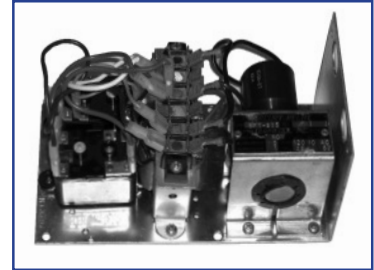

N4420300004 Control, CO6/CO8/TM8, Open Chassis, LH, Rebuilt

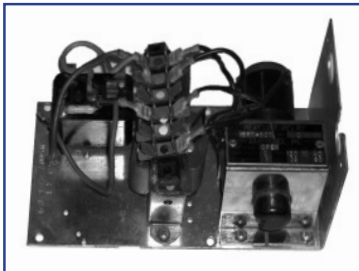

N4420300007 Control, Mercury Relay, CO6/CO8/TM8, Open Chassis, RH, Rebuilt



N9999990752 Capacitor, Motor Start



2500 & 4500

The global leader in
door opening solutions



N4000RIDDORC Operator,
Bi-fold, DD, OHC, Inswing,
w/RC, RH, Rebuilt



N4000LIDDORC Operator,
Bi-fold, DD, OHC, Inswing,
w/RC, LH, Rebuilt



N4000RODDORC Operator,
Bi-fold, DD, OHC, Outswing,
w/RC, RH, Rebuilt



N4000LODDORCR Operator,
Bi-fold, DD, OHC, Outswing,
w/RC, LH, Rebuilt



3000

The global leader in door opening solutions

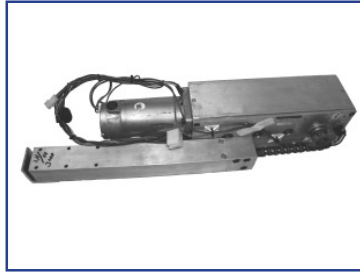

N3000LISSRCR Operator, Inswing, Square Shaft, SA, LH, Rebuilt



N3000RISSRCR Operator, Inswing, Square Shaft, SA, RH, Rebuilt

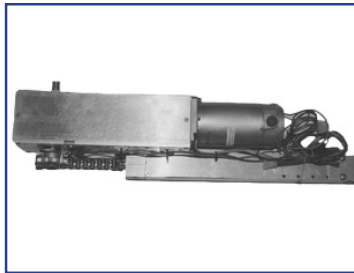

N3000LOSSRCR Operator, Outswing, Square Shaft, SA, LH, Rebuilt



N3000ROSSRCR Operator, Outswing, Square Shaft, SA, RH, Rebuilt

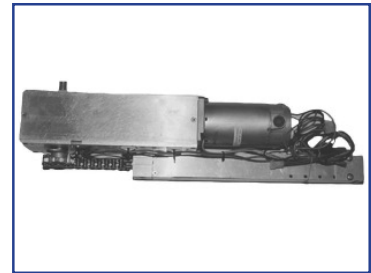

N3000LIDDORCR Operator, Inswing, DD Shaft, OHC, LH, Rebuilt



N3000RIDDORC Operator, Inswing, DD Shaft, OHC, RH, Rebuilt

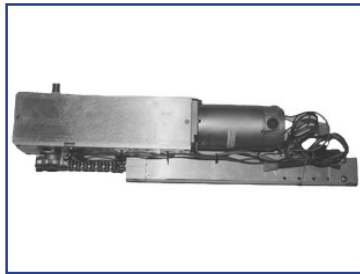

N3000LODDORCR Operator, Outswing, DD Shaft, OHC, LH, Rebuilt



N3000RODDORCR Operator, Outswing, DD Shaft, OHC, RH, Rebuilt

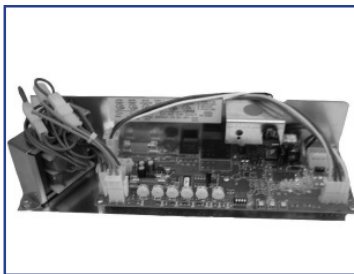

N4300517 Control, "K", Single, Rebuilt



N4300518 Control, "K", Dual, Rebuilt

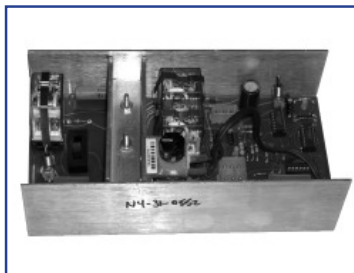

N4-31-0552 Control, 8 Pin, (KM), Rebuilt



N4300506 Switch, On/Off/Hold, Toggle



Remember - search for all parts online at www.besam-usa.com

© ASSA ABLOY Entrance Systems US Inc.

3500

The global leader in
door opening solutions



N3500LISS Operator,
Inswing, Square Shaft, SM, LH,
Rebuilt



N3500RISS Operator,
Inswing, Square Shaft, SM, RH,
Rebuilt



N3500LOSS Operator,
Outswing, Square Shaft, SM, LH,
Rebuilt



N3500ROSS Operator,
Outswing, Square Shaft, SM, RH,
Rebuilt



N4350901R Control, Single,
Rebuilt





N3800LOSSR Operator,
Outswing, Square Shaft, LH,
Rebuilt



N3800ROSSR Operator,
Outswing, Square Shaft, RH,
Rebuilt

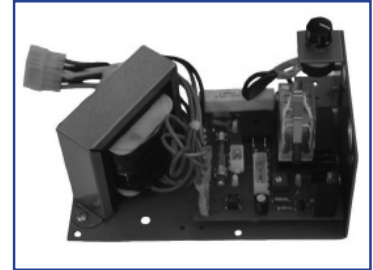

N4380510R Control, LH,
Rebuilt



MISC.

The global leader in door opening solutions



N4510107 Control, Jamb Display

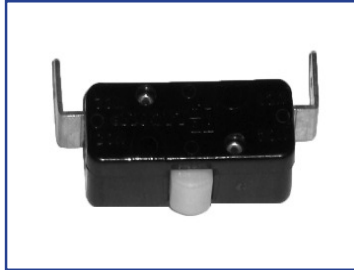

N441100003 Switch, Limit Licon

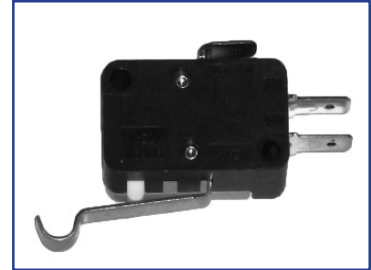

N9999730075 Switch, Micro

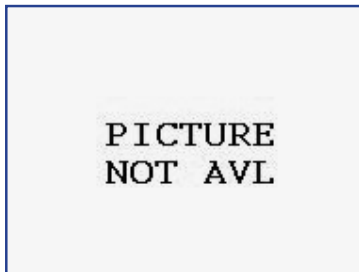

N4420000054 Arm, Slider, (TM)



N4430010294 Arm, TM8, Inswing, Straight



N4470001069 Guide, Bottom, Pin Only



N9999994824 Relay, Safety, 24 VAC, Coil



N9999994752 Relay, Motor, Start

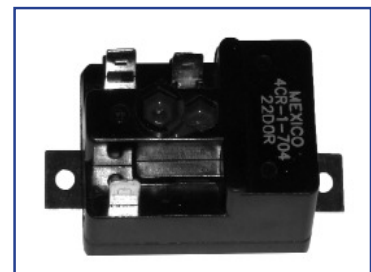

N9999994758 Relay, Motor, Selector



MISC.

The global leader in
door opening solutions



N9990112 Panic Ball (Only),
Active Panel



NFPC902 Hand Terminal,
8000, RENTAL ONLY



Add to 6000/8000 Swinger:
N9990071 - Lock Body
N9990074 - Lock Rod Assembly
N9800101R- OP/MTR/Cntrl 8100
N9800104CL- InSwing Arm ass'y

Add to 5100 Slider:
N9991322 - Control, System 20
N4510144R- Motor/Grbx " "

TABLE OF CONTENTS

Stanley

Slide

- Duraglide - Belt Drive
- Dynaglide - Linear Drive
- Magic Slide - Linear Drive

Swing

- Magic Swing - High Energy
- Magic Access - Low Energy
- Magic Force - High/Low Energy

ICU

Misc.

DURAGLIDE

The global leader in door opening solutions



S107506 Control, Wide, Yellow Rebuilt - **Obsolete - Use S313155****



S313155 Control, Narrow, Yellow, Rebuilt



S107506HD Control, Orange, RB



S107506XLR Control, XL, Red, Rebuilt



S185000 Control, MC521, Rebuilt



S18500 MC521 -New



S314117 MC521 Pro -New

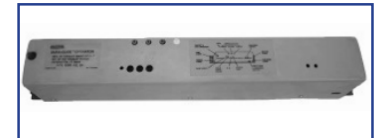

S3128911 Control, Grey, Rebuilt



S3128912 Control, Tan, Rebuilt

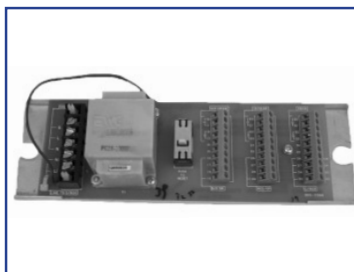

S313383 Board, Interface (Old style), Rebuilt

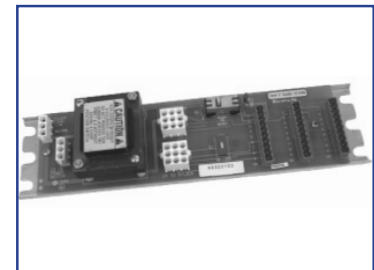

S516098 Board, Interface, (New style), Rebuilt, less connectors



DURAGLIDE

The global leader in door opening solutions



S313186R Gearbox/Motor, for 1000/5000, Rebuilt



S515801R Motor for 1000, Rebuilt

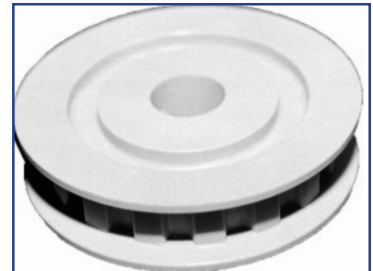

S412466 Pulley, Drive, Plastic for 1000 (Belt# USL075N)



S313443 Gearbox/Motor, Rebuilt



S514542RB Motor, w/RC, Rebuilt



S412139 Drive Pulley (Belt# USL075)



S415000 Power Harness, 18"



S411747 Cable Assy. Encoder Extension



S415001 Harness for Control (MC521)



Remember - search for all parts online at www.besam-usa.com

© ASSA ABLOY Entrance Systems US Inc.

DURAGLIDE

The global leader in door opening solutions



S312717 Rev-counter, Round, (New Style), Rebuilt



S312717R Rev-counter, Square, (Old Style), Rebuilt



S313034 Gearbox w/Pulley, Narrow Stile, Rebuilt



SDURAGB Gearbox, (Old Style), Rebuilt

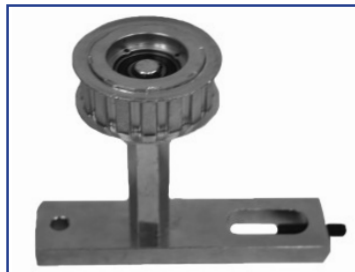

S515059 Pulley, Idler, Base/ Hardware



S411456 Pulley, Idler

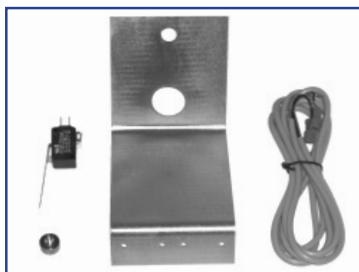

S312987 Switch, Door Position



S313465-5 Lock Kit, Electric, Fail Safe, RH, Rebuilt

S313465-6 Lock Kit, Electric, Fail Safe, LH, Rebuilt

Replaced by S313087 series on next page



S5168571 Assembly, Power & Function Switch- 8 ft



DURAGLIDE

The global leader in door opening solutions

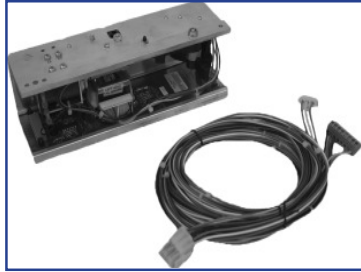

S313087-5 Lock Kit, Electric, Fail Safe, RH, Rebuilt



S313087-6 Lock Kit, Electric, Fail Safe, LH, Rebuilt



S313087-7 Lock Kit, Electric, Fail Secure, RH, Rebuilt



S313087-8 Lock Kit, Electric, Fail Secure, LH, Rebuilt



(for MC521)

S3139851 Solenoid Lock Assembly, Fail Safe, RH, New



S3139852 Solenoid Lock Assembly, Fail Safe, LH, New



S3139853 Solenoid Lock Assembly, Fail Secure, RH, New



S3139854 Solenoid Lock Assembly, Fail Secure, LH, New



S4129012 Harness, Solenoid Lock



S4129022 Harness, Board to Control



S170078 Power Supply/Battery Back-up, w/o Harness



S411842 Switch, Panic, Roller & Spring



S313692 Switch, 6 Position, Rotary



S313719 Switch, Rotary 6 Pos w/Harness



Remember - search for all parts online at www.besam-usa.com

© ASSA ABLOY Entrance Systems US Inc.

DURAGLIDE

The global leader in door opening solutions



S513720 Switch, 6 Position, Key

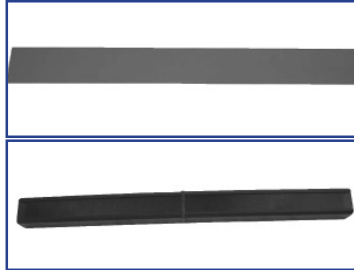

S412117 Lens, Stanguard Sensor (Top)

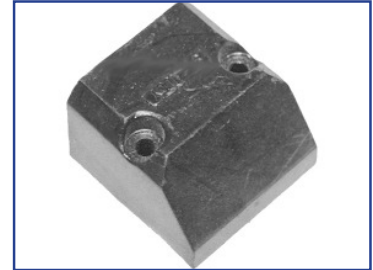

S712246 End Cap, Stanguard

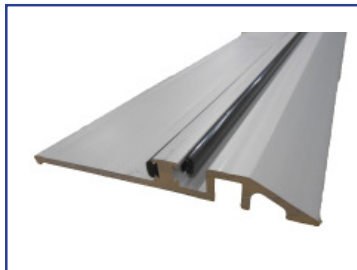

S516327 Threshold, 5-1/4 X 1/2", CL, w/Vinyl



S536327 Threshold, 5-1/4 X 1/2", DB, w/Vinyl



S312965 Sensor, Threshold, Stanguard, Rebuilt (Bottom)



S713081 Switch, Power, 2 Position, Rocker (Left)



S713082 Switch, Power, 3 Position Rocker (Right)

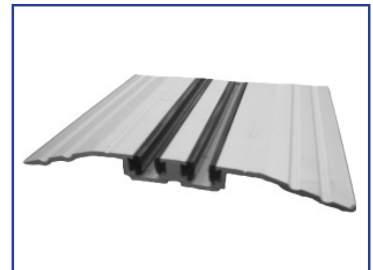

S515260 Track, Bottom Guide, Threshold, Beveled, 6" Wide, CL, w/Vinyl



S535260 Threshold, Tapered (both sides), 6", DB, w/Vinyl



S515262 Track, Bottom Guide, CL, w/Vinyl



S535262 Track, Bottom Guide, DB, w/Vinyl

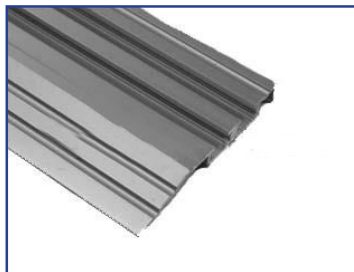

S516340 Threshold Tapered 4-1/2", CL



S536340 Threshold Tapered 4-1/2", DB

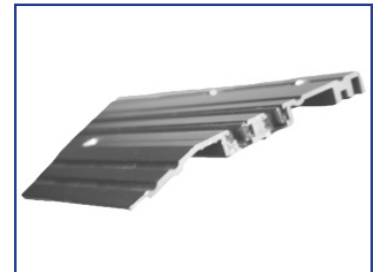

S516339 Track, Extrusion, Threshold, 6" Wide, Tapered (one side), CL, w/Vinyl



S536339 Track, Extrusion, Threshold, DB, w/Vinyl



DURAGLIDE

The global leader in door opening solutions

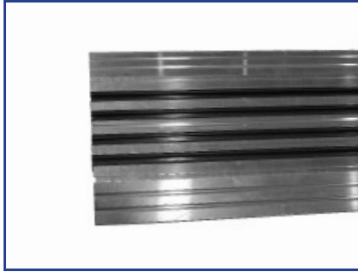

S515878 Extrusion, Threshold, Telescoping, CL, w/Vinyl



S535878 Threshold Tele, DB



S515878-9 Threshold 9 Ft, CL



S515878-10 Threshold 10 Ft, CL



S411796 Vinyl Wear Strip

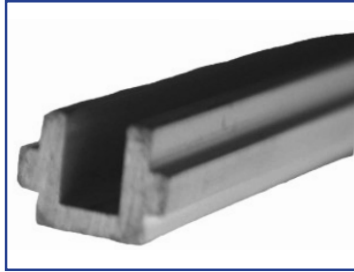

S411795 Filler Strip, Threshold, CL

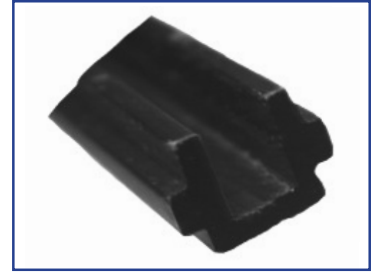

S431795 Filler Strip, Threshold, DB



S410100 Pivot, Bottom, SO, RH (RH Shown)



S410101 Pivot, Bottom, SO, LH

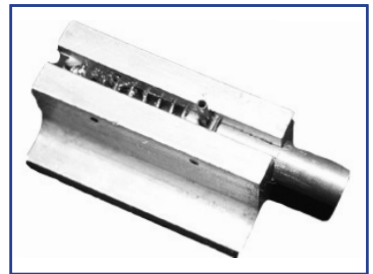

S411247 Pivot, Top, Panel, SO, LH (LH Shown)



S411248 Pivot, Top, Panel, SO, RH



S413828 Pivot, LH



S413829 Pivot, RH (Shown)



S711709 Stop, Full Open, RH (RH Shown)



S711710 Stop, Full Open, LH



S411858 Plate, Bottom Pivot, Outswing (Old Style)



Remember - search for all parts online at www.besam-usa.com

© ASSA ABLOY Entrance Systems US Inc.

DURAGLIDE

The global leader in door opening solutions



S708950 Pivot, Bottom, FBO, for 3000



S413311 Guide, Bottom, Nylon, Non-panic



S5152651 Guide, Bottom, w/Aluminum Mounting Block



S515191 Guide, Bottom, FSL, Small Roller, RH (RH Shown)



S515192 Guide, Bottom, FSL, Small Roller, LH



S117244 Bottom Guide Roller (small)



S5151911 Guide, Bottom, Large Roller, RH (RH Shown)



S5151921 Guide, Bottom, Large Roller, LH



S117244L Bottom Guide Roller (large)



S516777 Guide, Bottom, Non-panic, Target



S312462 Roller, Anti-rise



STANLEY

ASSA ABLOY

DURAGLIDE

The global leader in
door opening solutions

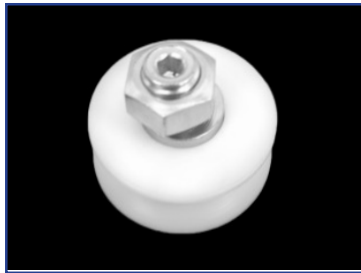

S312729 Roller Hanger



S312729N Roller, Hanger
OEM, Duraglide



S414011 Load Wheel, Double
Diamond



S313651 Cable Kit, IS1000



S411622 Panic Latch,
Carriage, CL



S411624 Felt Pile, Self
Adhesive, 1/4" Back, 5/16",
Brown



S411709 Door Holder, 15",
Outswing, for 3000



S412680 Door Holder, 10"



S411714 Shoulder Screw, Arm
to Header



S413830 Damper Assembly



Remember - search for all parts online at www.besam-usa.com

© ASSA ABLOY Entrance Systems US Inc.

DURAGLIDE

The global leader in
door opening solutions

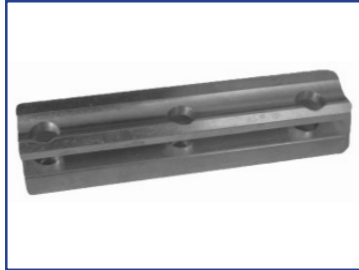

S515909 Ball Detent Door Portion, RH



S515910 Ball Detent Door Portion, LH



S711568 Interlock, for 3000, CL



S7133331 Interlock, Diamond Series

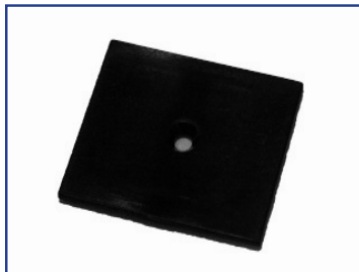

S515190 End Cap Hanger, DB



S5151932 Lock, Bipart w/Rod



S515193 Lock, Bipart w/Rod, Narrow Style (SHOWN)



S708867 Latch, Panic Door

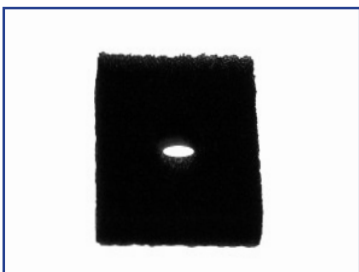

S711741 Hanger, Foam Filler



1702464 Kit, Jamb Cam



S713901 Cable, Jamb Cam to Recorder



1702644 Sensor, Besam SC53-MV Sensor w/Video(IXIO-V)



(was 1702077)

DURAGLIDE

The global leader in door opening solutions



S713067 Bottom Ball Catch Adapter Plate only, Duraglide

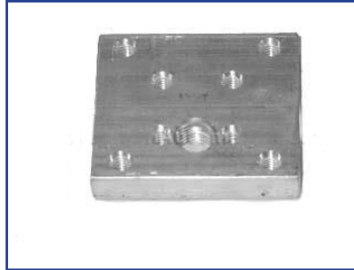

S411794 SO Bottom Pivot Plate only



S112005 Encoder, Dual Plug, RB



S413973 Switch, 3-Pos Rotary



S313918 Bracket, Cable & Mounting, Tele



S413454 Bi-Fold Mag Panic Switch



S313506R Gearbox, 3/8" Belt, RB



S713080 Switch, Entry, Reduced Open



S411810 Clamp Kit, Short Bracket



S313105 Arm, PSA, Duraglide



S714335 Load Wheel, 2-pc, 5400



S412465 Pulley, Idler, 3/8" Belt



Remember - search for all parts online at www.besam-usa.com

© ASSA ABLOY Entrance Systems US Inc.

9A Rev E

DYNAGLIDE

The global leader in door opening solutions



S312142 Control, Rebuilt

OBSOLETE



S410886RB Motor, BK, Rebuilt



S410801 Switch, Panic, Roller/Bracket



S311375 Guide, Bottom, FBO



S709929 Guide, Bottom, FSL, LH



S709930 Guide, Bottom, FSL, RH

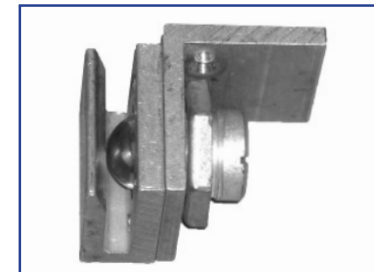

S708957 Latch, Panic, LH

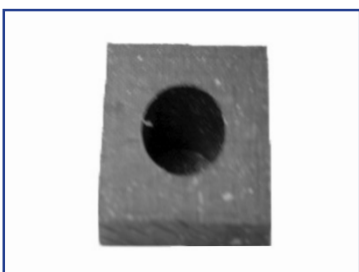

S312143 Drive Block Cushion



S708473 Coupling, Motor to Shaft



S708965 Roller, Hanger, 1/2"



DYNAGLIDE

The global leader in door opening solutions



S709609 Pulley, Idler Cable Sheeve



S312892 Cable



S412472 Glass Stop Gutter, Square, w/Rubber



S412637 Glass Stop, Gutter, Beveled, w/Rubber



S432472 Glass Stop, Gutter, 1/4", w/Rubber, DB



S432569 Glass Stop, Beveled, w/Rubber, BZ



S706812 Glass Stop, Glazing, Bead, Vinyl, BK



S737807 Glass stop 1/4", Square, w/Vinyl, DB



S717807 Glass Stop, 1/4", Square, w/Vinyl, CL



S432637B Glass Gutter, Beveled, 1/4", w/Rubber, DB

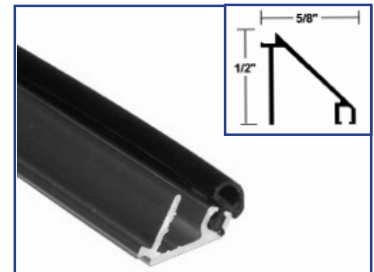

S412569 Glass Stop, 1/4", Beveled w/Rubber, CL, 4 Ft.



Remember - search for all parts online at www.besam-usa.com

© ASSA ABLOY Entrance Systems US Inc.

MAGIC SLIDE

The global leader in
door opening solutions



S311625 Control, Rebuilt

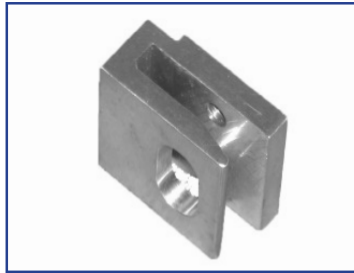

S708918 Latch, Panic,
Carriage Portion



S410886RB Motor, BK, Rebuilt



S709929 Guide, Bottom, FSL,
LH



S709930 Guide, Bottom, FSL,
RH



MAGIC SWING



S312154 Control, Silver, Rebuilt



S312422 Control, Black, 4 Knob, Rebuilt

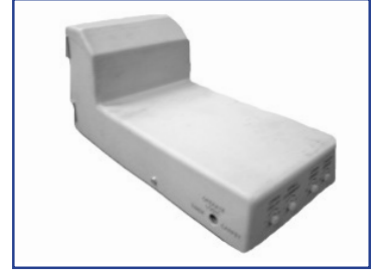

S312825 Control, Tan, 4 Knob, Rebuilt



S313167 Motor, Rebuilt



S313153 Control, Rebuilt

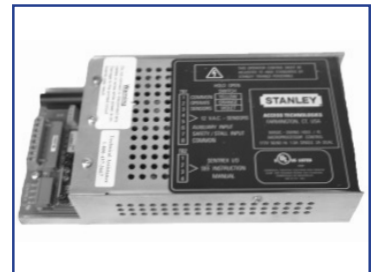

S313854 Control, HDLE/FE, MP, Black Label, Rebuilt



S514542RB Motor, w/RC, Rebuilt



S312717 Rev-counter, Round, (New Style), Rebuilt



S312717R Rev-counter, Square, (Old Style), Rebuilt



Remember - search for all parts online at www.besam-usa.com

© ASSA ABLOY Entrance Systems US Inc.

MAGIC SWING

The global leader in door opening solutions

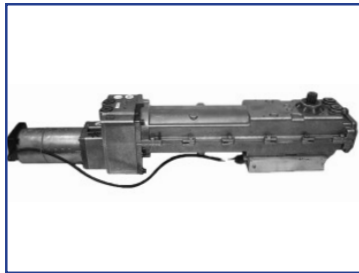

S312152RC2 Operator, w/RC, 5/8", OHC, RH, Ultralight, Rebuilt

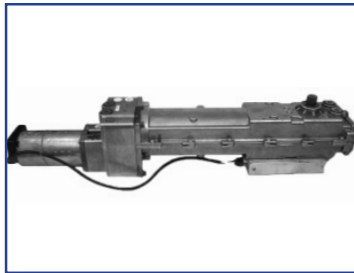

S312152RC3 Operator, w/RC, 1/2", OHC, RH, Rebuilt

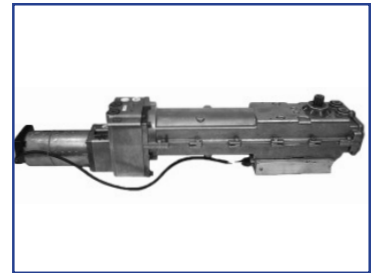

S312152RC4 Operator, w/RC, 5/8", OHC, RH, Rebuilt

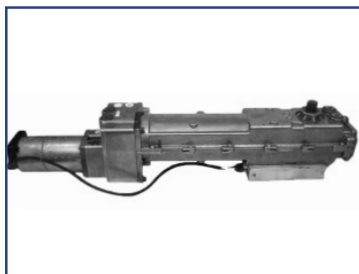

S312152RCS Operator, w/RC, SM, RH, Rebuilt



S312153 Operator, w/RC, SM, LH, Rebuilt



S312153RC2 Operator, w/RC, 5/8", Ultralight, LH, OHC, Rebuilt



S312153RC4 Operator, w/RC, 5/8", OHC, LH, Rebuilt



S312153S Operator, w/RC, 1/2", Reg. Spring, LH, Rebuilt



S312299 Operator, 5/8", RH, No R/C, OHC, SM, Rebuilt



MAGIC SWING

The global leader in door opening solutions



S312299S Operator, 5/8", RH, SM, No R/C, Rebuilt



S312300 Operator, OHC, LH, No Rev. Ctr., Rebuilt



S312300S Operator, 5/8", LH, SM, No Rev. Ctr., Rebuilt



S312889 Operator, w/RC, 1/2", Ultralight, OHC, RH, Rebuilt



S313254 Operator, w/RC, 5/8", Ultralight, OHC, RH, Rebuilt



S312890 Operator, w/RC, 1/2", Ultralight, OHC, LH, Rebuilt

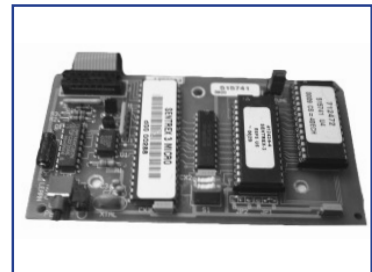

S515741 Board, Main, Sentrex 3, (New Style)

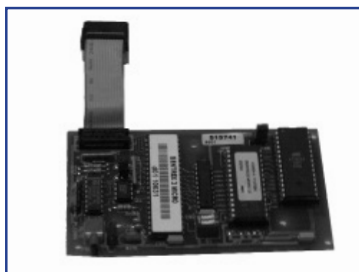

S313154 Board, 3 Main Sentrex

Replaced by S515741



S313185PL Replacement Plates, Sentrex



S313185 Sentrex, 3 Sensor, Rebuilt



Remember - search for all parts online at www.besam-usa.com

© ASSA ABLOY Entrance Systems US Inc.

MAGIC SWING

The global leader in door opening solutions



S545602 Head Cover, Sensor, Sentrex



S412435 Power Cable (3), Flex Link, Sentrex Heads



S313367 Power Close Module, RB



S515735 Harness, Main Power (single door)



S515736 Harness, Main Power (dual door)



S516214 Controller, Speed Close



S313664 Spindle Extension, Bifold



S312249 Arm, Inswing, RH



S312250 Arm, Inswing, LH

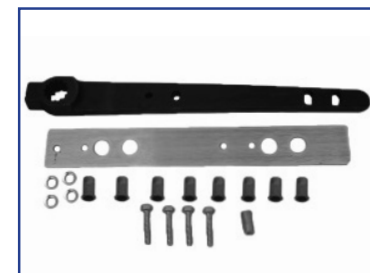

S311652 Arm, OHC, Complete Kit

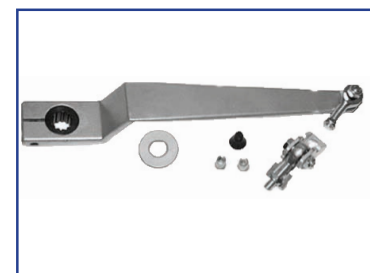

S312251 Arm, Outswing (Can use Besam arm rods)



MAGIC SWING

The global leader in door opening solutions



S410872 Track, Door Arm, Inswing, 15 1/2", CL

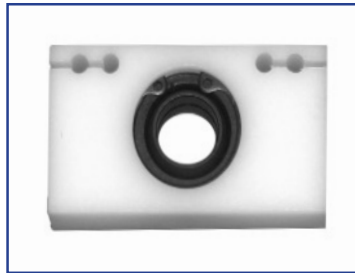

S710706 Slide, Block, Nylon



S311727 Pivot, Bottom & Threshold



S312847 Pivot, Recessed



S312976 Pivot, Threshold Plate & Bottom (tapered)



S710151 Pivot, Screw, Bottom



S712044 Weather Strip, Pile



S514878 End Cap



Remember - search for all parts online at www.besam-usa.com

© ASSA ABLOY Entrance Systems US Inc.

MAGIC SWING

The global leader in
door opening solutions

Stanley MagicSwing Operator Breakdown

DCS P/N System	BAAN P/N	Description
R312152	S312299	MG/SW OPER ASSY, RH, OHC, 5/8", No R/C
R312152P	n/a	MG/SW OPER ASSY, RH, OHC, 5/8", No R/C, w/Pin
R312152RC-1	S312889	MG/SW OPER ASSY, RH, OHC, 1/2", UltraLight, w/RC
R312152RC-2	S312152RC2	MG/SW OPER ASSY, RH, OHC, 5/8", UltraLight, w/RC
R312152RC-3	S312152RC3	MG/SW OPER ASSY, RH, OHC, 1/2", w/RC
R312152RC-4	S312152RC4	MG/SW OPER ASSY, RH, OHC, 5/8", w/RC
R312152RCS	S312152RCS	MG/SW OPER ASSY, RH, SM, 5/8", w/RC
R312152S	S312299S	MG/SW OPER ASSY, RH, SM, 5/8", No RC
R312153	S312300	MG/SW OPER ASSY, LH, OHC, 5/8", No RC
R312153P	n/a	MG/SW OPER ASSY, LH, OHC, 5/8", No RC, w/Pin
R312153RC-1	S312890	MG/SW OPER ASSY, LH, OHC, 1/2", UltraLight, w/RC
R312153RC-2	S312153RC2	MG/SW OPER ASSY, LH, OHC, 5/8", UltraLight, w/RC
R312153RC-3	S312153S	MG/SW OPER ASSY, LH, OHC, 1/2", w/RC
R312153RC-4	S312153RC4	MG/SW OPER ASSY, LH, OHC, 5/8", w/RC
R312153RCS	S312153	MG/SW OPER ASSY, LH, SM, 5/8", w/RC
R312153S	S312300S	MG/SW OPER ASSY, LH, SM, 5/8", No RC

- S = SURFACE MOUNTED
- P = PIN FOR REV COUNTER
- RC = REV COUNTER
- 1 = 1/2" BALL SCREW HANDICAP
- 2 = 5/8" BALL SCREW HANDICAP
- 3 = 1/2" BALL SCREW
- 4 = 5/8" BALL SCREW

MAGIC ACCESS

The global leader in door opening solutions

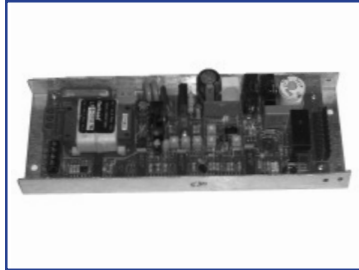

S3131791 Control, Low Energy, Rebuilt



S313530R Control, Dual, Rebuilt

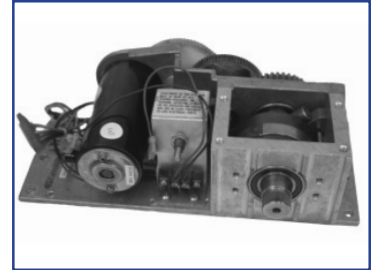

S1103781R Operator, Outswing, RH, Rebuilt

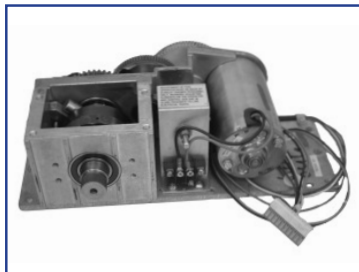

S1103791R Gearbox Motor, Outswing, LH, Rebuilt



S1103782R Operator, Inswing, RH, Rebuilt

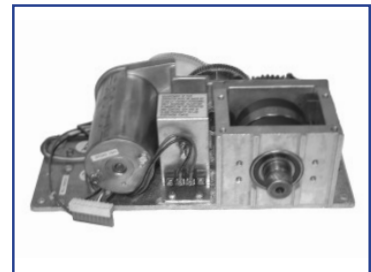

S1103792R Operator, Inswing, LH, Rebuilt



S313242R Motor, Rebuilt

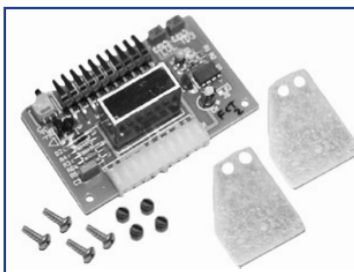

S313150 Control Board, Power Close



S110564 Arm, Operator Concealed



Remember - search for all parts online at www.besam-usa.com

© ASSA ABLOY Entrance Systems US Inc.

MAGIC ACCESS

The global leader in
door opening solutions



S313160 Arm, Outswing, CL

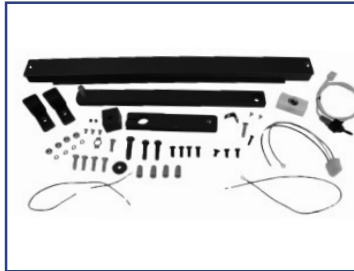

S313180 Arm, Inswing
w/o Breakout, DB



S313161 Arm, Inswing,
0" Reveal



S333160 Arm, Outswing,
Breakout, DB



MAGIC FORCE

The global leader in door opening solutions

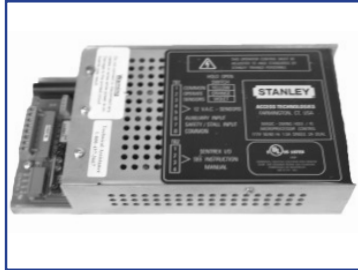

S313854 Control, HDLE/FE, MP, Black Label, Rebuilt



S313852LRB Operator, LH, Rebuilt



S313852RRB Operator, RH, Rebuilt



S415001 Harness for Control (MC521)



S413791 Harness, Cam Assembly



S185000 Control, MC 521, Rebuilt



S1850001 Control, MC 521, SINGLE, Rebuilt



S18500 Control, MC 521, New

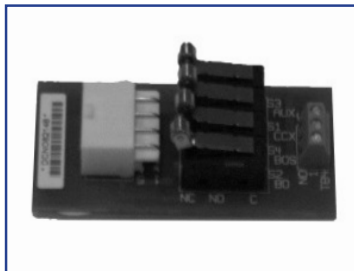

S516671 Limit Switchboard

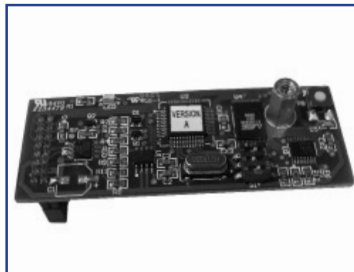

S516834 Microboard, Sentrex, New, (MC521)



S516834R Microboard, Sentrex, Rebuilt



S314117 Control, MC 521 Pro, New

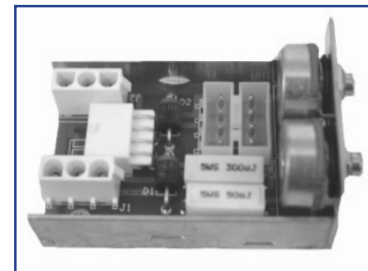

S516660 Control, Speed Close, Rebuilt



S712811 Grommet, Operator, Recessed



S312717 Rev-counter, Round, (New Style), Rebuilt



Remember - search for all parts online at www.besam-usa.com

© ASSA ABLOY Entrance Systems US Inc.

STANLEY

ASSA ABLOY

ICU

The global leader in
door opening solutions

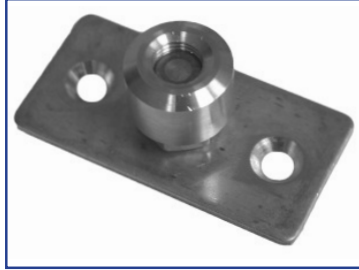

S515716 Pivot, Trackless,
Floor Portion, 7000TL



S5151911 Guide, Bottom,
New Style, R/H



S5151921 Guide, Bottom,
New Style, L/H



S516855 Pivot, Bottom Assem-
bly ICU 7000



MISC.

The global leader in door opening solutions



S713861 Programmer, Control, Palm, (MC521)

Obsolete



S414104 Switch, 2 Position, Rotary



S310079 Pivot, Top, Retractable

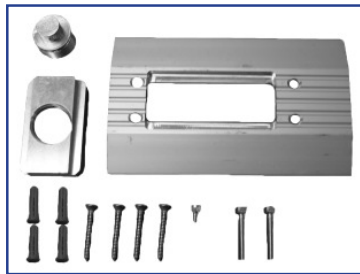

S3129031 Pivot, Bottom, Pkg., Adj., Taper, B/F

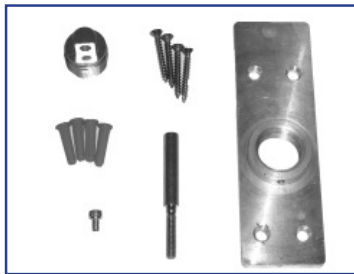

S313735 Pivot, Bottom & 6" Threshold



S410895 Pivot, Bottom, Door Port Only



S706208 Pivot, Bottom, Outswing



S710150 Pivot, Bottom Bearing



S310891 Wiper



Remember - search for all parts online at www.besam-usa.com

© ASSA ABLOY Entrance Systems US Inc.

STANLEY

STANLEY MISC.

ASSA ABLOY

The global leader in
door opening solutions



S311770 Brush, Motor,
Stanley/RAE - N/A as Service Part



S312164 Bolt, Bearing

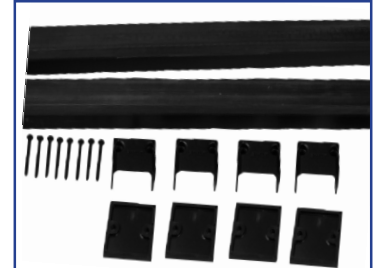

S343718 Cart Bar Kit

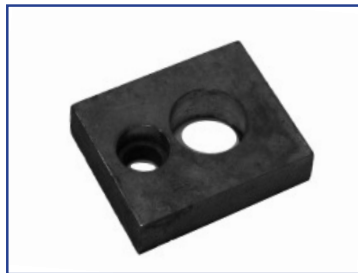

S401544 Block, Bushing Ends



S411746 Ext. Cable Motor to
Controller



S412498 Roller, Carrier for
1000



S412544 Harness, Line
Connect, 6 Ft.



S413379 Follower, Bi-fold for 5600



S413426 Bi-fold, Hinge, RH



USBDONGLE MC521 Bluetooth
Dongle Assembly



USREVERSEMONITOR Reverse Camera Monitor

S413427 Bi-fold, Hinge, LH

phone: 888-732-3726

parts.na.besam@assaabloy.com

fax: 800-304-9459

© ASSA ABLOY Entrance Systems US Inc.

STANLEY

STANLEY MISC.

ASSA ABLOY

The global leader in
door opening solutions



S413936 Anti-riser, Double
Diamond



S515252 Friction Slide



S515787 Idler Bracket Only,
5300 Series



S515885 Bracket, Belt, Long,
3/8", 5300 Series



S314096 BlueTooth Interface
Kit (Palm to Control)

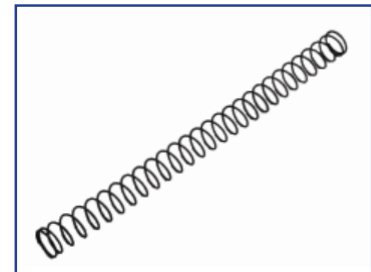

S605538 Spring, Check
Cylinder



S708827 Solenoid, Coil,
Pneumatic Swing



S711463 Breakout Switch



S516075 Assembly, Belt
Bracket, Long



S516861 MC521 5W Resistor Ass'y



Remember - search for all parts online at www.besam-usa.com

© ASSA ABLOY Entrance Systems US Inc.

STANLEY

**STANLEY
MISC.**

ASSA ABLOY

The global leader in
door opening solutions



S161582 Breakout Track
Assembly, RH, Dark Bronze



S161583 Breakout Track
Assembly, LH, Dark Bronze

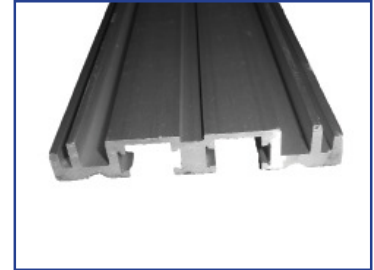

S517081 Threshold Track

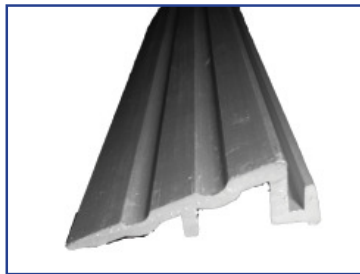

S517082 Extrusion, Lead-Up



S71411911 Key, 6-Position Switch

